

**SYCHEM SURGICAL**

# **SURGICAL INSTRUMENT CATALOGUE**



**LEADING UK MANUFACTURER  
OF SURGICAL INSTRUMENTS**



## COMPANY PROFILE

Combining over 100 years of experience in the sterilisation industry with over 75 years of manufacturing surgical instruments, Sychem Surgical has positioned itself as leading specialists in the medical, healthcare, and laboratory sectors. Sychem Group was established in 2003, initially supporting a range of industries to reduce the spread of bacteria and viruses, and building a reputation over the years as leading suppliers of decontamination and sterilisation equipment. In 2023, Sychem Group acquired the surgical division of S Murray Ltd, a well established surgical instrument manufacturer based in Sheffield, UK, which has now become Sychem Surgical. S Murray have been manufacturing from their facility since 1946 and bring a wealth of experience and knowledge to our evergrowing team. The benefits of manufacturing in Sheffield include immediate access to raw materials, technical expertise and skilled personnel, for which the region is internationally recognised as a centre of excellence. Sales administration, warehousing and distribution are based at our offices in Sheffield, UK. Sychem Surgical plays an active role in the representation and development of British manufacturing on a national and international level through its membership of the Surgical Instruments Section of the Association of British Health-Care Industries (ABHI).

## THIS CATALOGUE

Instruments are listed alphabetically according to surgical procedure (see contents page v). They are also listed both by name and instrument type in the comprehensive cross-referenced index starting on page 237.

Line drawings have been used throughout to provide best possible clarity. There is an indication of the relative sizes of instruments shown on each page, but drawings are not to exact scale. Inset drawings of instrument tips are intended to show detail, only T/C needleholder tips are actual size.

Instructions for reprocessing reusable surgical instruments are given on page IV.

## GUARANTEE

The quality of all Sychem Surgical instruments is guaranteed to be free of defects in workmanship and materials. In the unlikely event that any item is found to be unsatisfactory in normal use it will be refurbished or replaced free of charge. This guarantee is firm for at least 10 years, except for replacement of T/C tips on needleholders and re-sharpening of hard edge scissors, which will be free of charge for 3 years.

## QUALITY

All Company personnel are committed to improve and enhance quality procedures at all levels of production, purchase and supply.

Sychem Surgical products are ISO13485 certified, assuring customers of continued professional service, and properly controlled quality of product.

Sychem Surgical will continue to maintain its approval to the latest revisions of all relevant quality standards, with copies of our current certificates of approval available upon request. Instruments of a special nature, which are not within the Company's manufacturing programme, originate only from manufacturers whose quality assurance procedures are thoroughly known to Sychem Surgical Ltd. The Company is also committed to the development of all employees through the principles of the Investors in People Standard.

Products in this catalogue (except for diathermy instruments and tracheostomy tubes, which are subject to notified body approval) are Class I Devices according to rule 6, annex IX of the Council Directive concerning Medical Devices (93/42/EEC) and they comply with all relevant essential requirements of that Directive.

Patterns defining the form of these instruments and procedures defining method of manufacture are maintained as part of the Company's quality system, with full traceability throughout every stage of the manufacturing process.





## INSTRUMENTS

Suitable for theatre, ward, veterinary, dental and chiropody use; manufactured from high grade stainless steel, all instruments comply with the specifications set by ISO 13485

Standard instruments are finished to a bright mirror polish; specialised instruments include Tungsten Carbide Needle holders – satin finished with gold plated bows; also Diathermy Forceps with distinctive blue insulation.



## SCISSORS

Manufactured by specialists, working to the same quality criteria as the company's instrument makers.

All scissors have bright mirror polish finish; Hard Edge Scissors have stellite blades and gold plated bows; Ultracut Scissors have serrated top blades to prevent tissue slippage and razor edged bottom blades to allow precise effortless cutting.



## SERVICE

Comprehensive catalogues are available in book and CD ROM formats to support both U.K. and overseas distributors.

Large stocks held in Woking and part finished components at Sheffield allow best possible delivery times. Visitors are welcome at the Sheffield factory to experience the company's commitment to quality throughout the manufacturing process.





# INSTRUCTIONS FOR RE-PROCESSING REUSABLE DEVICES

The following instructions are for all reusable medical devices shown in this catalogue, unless stated otherwise with the packaging of the product. These instructions are intended for use only by persons with the required specialist knowledge and training.

## WARNINGS

- Follow instructions and warnings as issued by manufacturers of any decontaminants, disinfectants and cleaning agents used. Wherever possible avoid use of mineral acids and harsh, abrasive agents.
- No part of the process shall exceed 140°C.
- Aluminium based products are damaged by high alkaline solutions (pH >10).
- Devices with long, narrow cannula, hinges and blind holes require particular attention during cleaning.

## Limitations on Reprocessing

- Repeated processing has minimal effect on these instruments.
- End of life is normally determined by wear and damage in use.
- Any specific limitations on the number of reprocessing cycles shall be made available with the instrument.

## INSTRUCTIONS

### From Point of Use

- If possible, soiled instruments should be placed in a holding solution (combined disinfectant / enzyme solution) immediately after use and prior to cleaning, avoiding the use of bleach-based solutions.

**Note:** *this process is not suitable for aluminium instruments.*

### Preparation for Decontamination

- Disassemble where intended by trained staff only, without the use of tools unless specifically provided by the manufacturer.
- Reprocess all instruments as soon as it is reasonably practical following use.

### Cleaning: Automated

- **Use only either CE marked or validated washer-disinfector machines and cleaning agents, following the manufacturers' instructions for use, warnings and recommended cycles.\***
- Load instruments carefully, with any box joints and hinges open and so that any fenestrations in instruments can drain.
- Place heavy instruments with care in the bottom of containers.
- Place instruments with concave surfaces (e.g. curettes) facing down to prevent pooling of water.

### Cleaning: Manual

- **Manual cleaning is not advised if an automatic washer-disinfector is available. If this equipment is not available, use the following process:** -

**One:** Using a sink dedicated for instrument cleaning (not used for hand washing), rinse excess soil from instrument (water temp <35°C).

**Two:** Keeping the instrument submerged in the water, with a brush, apply CE marked cleaning solution to all surfaces. Pay particular attention to serrations, teeth, ratchets and hinges, always brushing away from the body. Ensure rongeurs and hinged instruments are thoroughly cleaned in both open and closed positions.

**Three:** Rinse instruments thoroughly with clean water, so that the water reaches all parts of the instrument, then carefully hand dry or use an industrial drying cabinet.

**Note:** *when manual cleaning is used it may not be possible to disinfect the device prior to further handling.*

### Cleaning: Inspection

- After cleaning, check all surfaces, cannulations, holes and lumens for complete removal of soil.
- If any soil is still visible, return the instrument for repeat decontamination.

**Note:** *automated cleaning may not be suitable for all lumens and cannulae, in which case clean manually with an appropriate brush (and stilette if provided) that reaches the depth of the feature.*

### Maintenance

- Apply surgical grade lubrication oil to hinges, joints and moving parts as per the lubrication oil manufacturer's instructions.

### Inspection and Function Testing

- Visually inspect and check:-
  - all instruments for damage and wear
  - cutting edges are free of nicks and present a continuous edge
  - jaws and teeth align correctly
  - all articulated instruments have a smooth movement without excess play
  - locking mechanisms (such as ratchets) fasten securely and close easily
  - long, slender instruments are not distorted
  - any component parts fit and assemble correctly with mating components.

- Remove for repair or replacement any blunt, worn out, flaking, fractured or damaged instruments.

**Note:** *if an instrument is returned to the manufacturer / supplier, the instrument must be decontaminated and sterilised and be accompanied with the relevant documented evidence.*

### Packaging

- All instruments to be packed following local protocol in accordance to BS standards.

### Sterilisation

- **Either CE marked or validated vacuum autoclave operating at 134-137°C 2.25 bar for a minimum holding time of 3 minutes - always following the instructions of the machine manufacturer.**
- When sterilising multiple instruments in one autoclave cycle, ensure that the steriliser manufacturer's stated maximum load is not exceeded.
- Ensure instruments are dry before sterilisation. If the instruments cannot be dried prior to sterilisation, then use distilled/de-ionised water in the final-rinse stage of cleaning.

### Storage

- Ensure instruments are dry before storage, and stored in dry, clean conditions at an ambient room temperature and away from direct sunlight.

### Additional Information

- Other forms of **cleaning** (ultrasonic, alkaline and neutral) and **sterilisation** (Low Temperature Steam, Formaldehyde, Ethyleneoxide and Gas Plasma) are available. However, always follow the instructions for use as issued by the manufacturer and always consult with them if in any doubt over the suitability of any process used.

\* **Follow cleaning and sterilisation guidelines as per HTM 2010 and HTM 2030.**

It is the responsibility of the reprocessor to ensure that the reprocessing as actually performed using equipment, materials and personnel in the reprocessing facility achieve the desired result. This requires validation and routine monitoring of the process. Likewise any deviation by the reprocessor from the instructions provided must be properly evaluated for effectiveness and potential adverse consequences.



<b>GENERAL SURGERY</b>	<b>vi</b>	<b>GEN</b>
<b>THORACIC SURGERY</b>	<b>62</b>	<b>THO</b>
<b>GYNAECOLOGY &amp; OBSTETRICS</b>	<b>70</b>	<b>GYN</b>
<b>UROLOGY</b>	<b>86</b>	<b>URO</b>
<b>PROCTOLOGY</b>	<b>90</b>	<b>PRO</b>
<b>DENTAL INSTRUMENTS</b>	<b>98</b>	<b>DENT</b>
<b>CHIROPODY INSTRUMENTS</b>	<b>134</b>	<b>CHIR</b>
<b>NEUROSURGERY</b>	<b>138</b>	<b>NEU</b>
<b>ORTHOPAEDIC SURGERY</b>	<b>156</b>	<b>ORTH</b>
<b>EAR, NOSE &amp; THROAT</b>	<b>178</b>	<b>ENT</b>
<b>PLASTIC SURGERY</b>	<b>218</b>	<b>PLA</b>

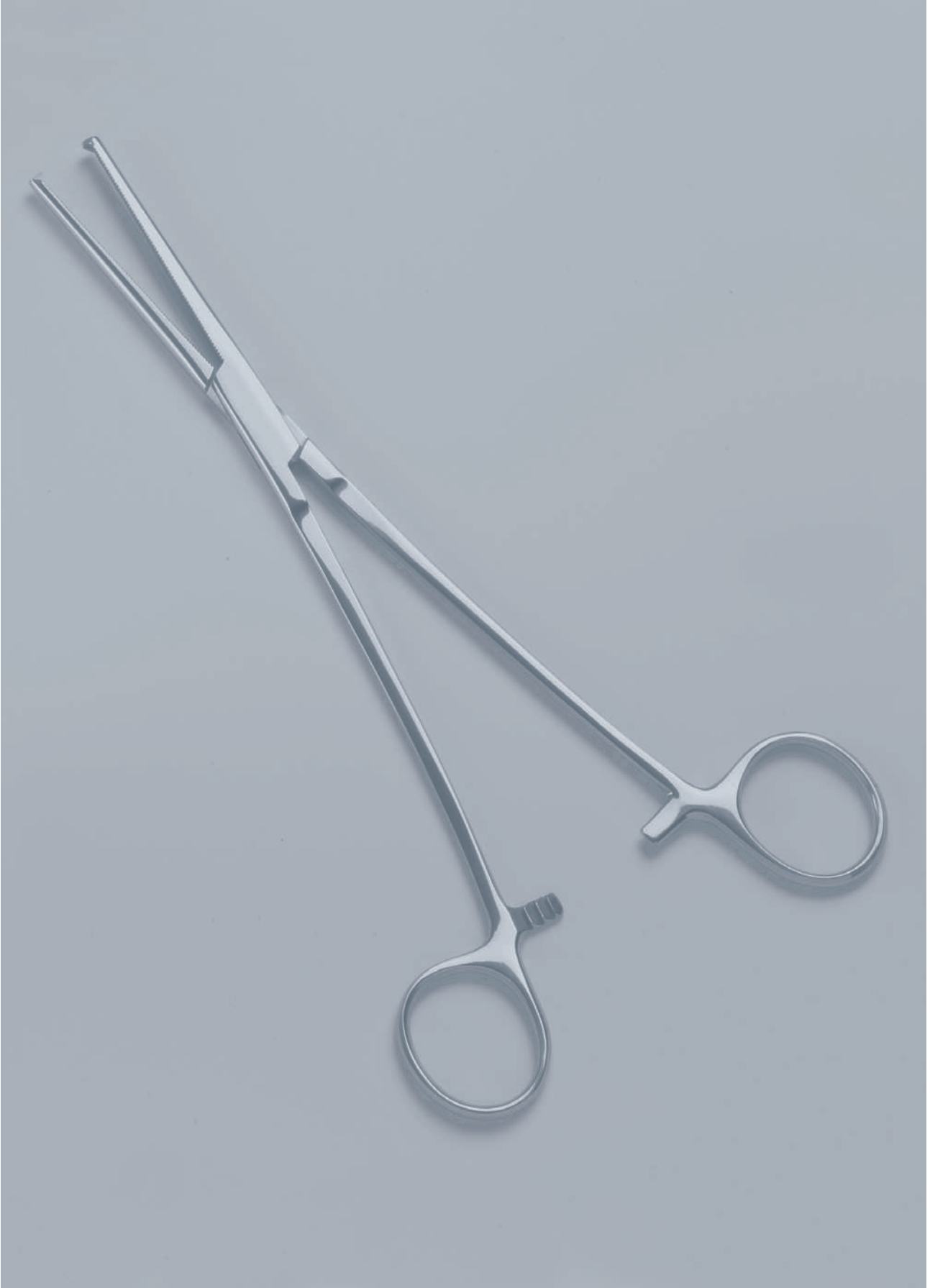



## ANCHORING FORCEPS

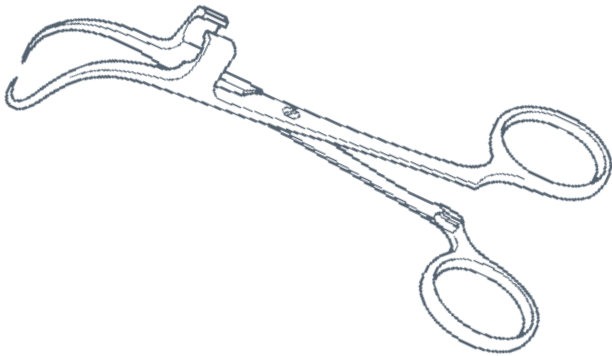

### Robin

screw joint

**1005/05** 5mm diameter holder for diathermy leads, 140mm

**1005/10** 13mm diameter holder for suction tubing, 140mm

**1005/15** 25mm diameter holder for anaesthetic tubing, 140mm

## ARTERY FORCEPS

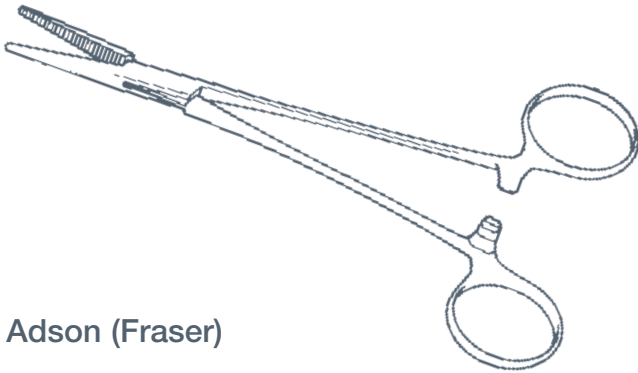

### Adson (Fraser)

straight

**1017/05** 180mm

curved

**1018/05** 180mm

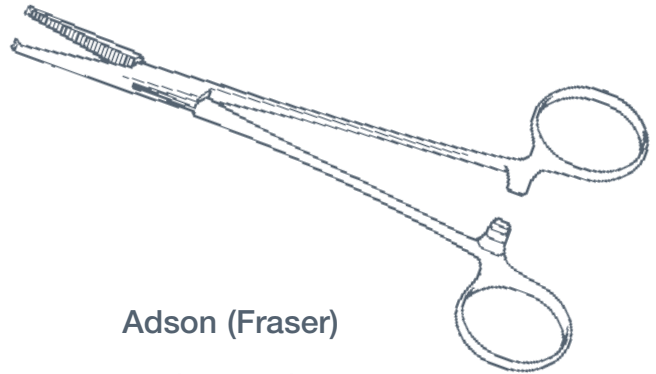

### Adson (Fraser)

straight, 1/2 teeth

**1019/05** 180mm

curved, 1/2 teeth

**1020/05** 180mm

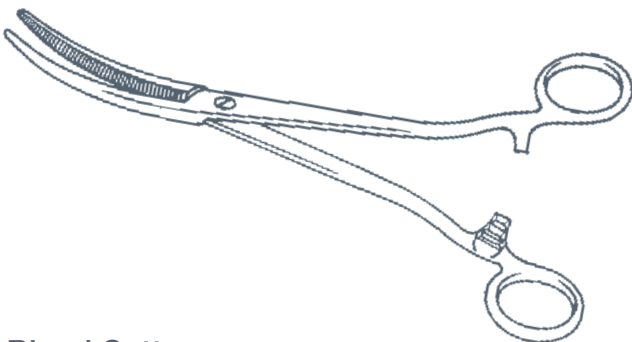

### Bland Sutton

curved, screw joint

**1026/05** 180mm

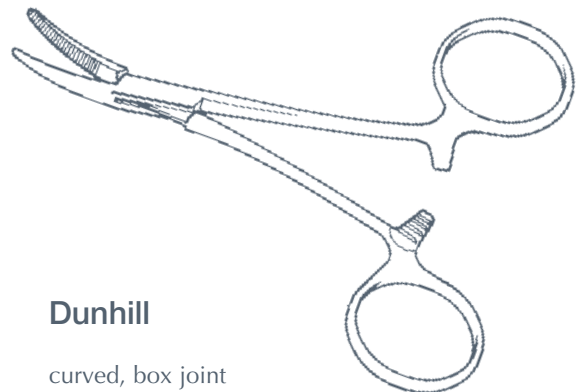

### Dunhill

curved, box joint

**1034/05** 125mm

**1034/10** 180mm

straight, box joint

**1035/05** 125mm





## ARTERY FORCEPS

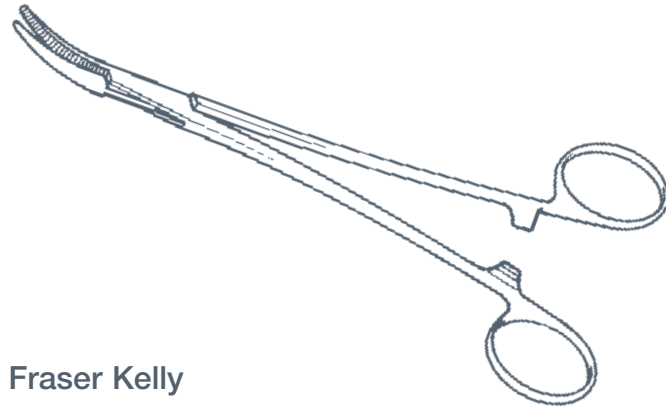

**Fraser Kelly**

curved  
1038/05 180mm



**Grey Turner**

straight  
1040/05 145mm  
1040/10 180mm  
curved  
1041/05 145mm  
1041/10 180mm

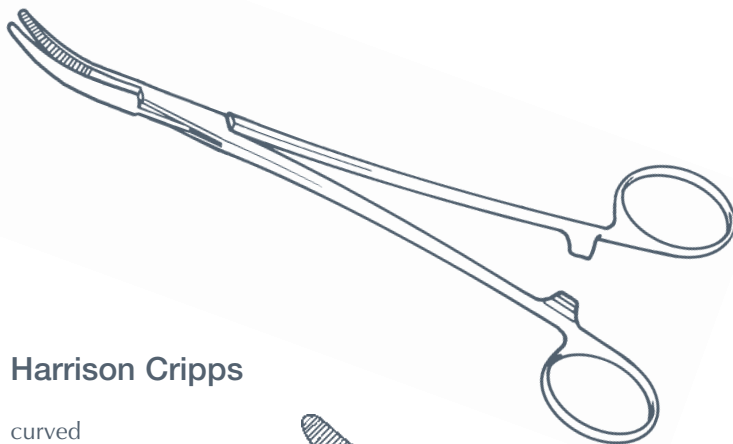
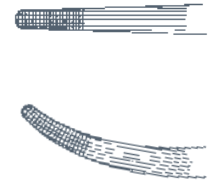

**Harrison Cripps**

curved  
1042/05 175mm

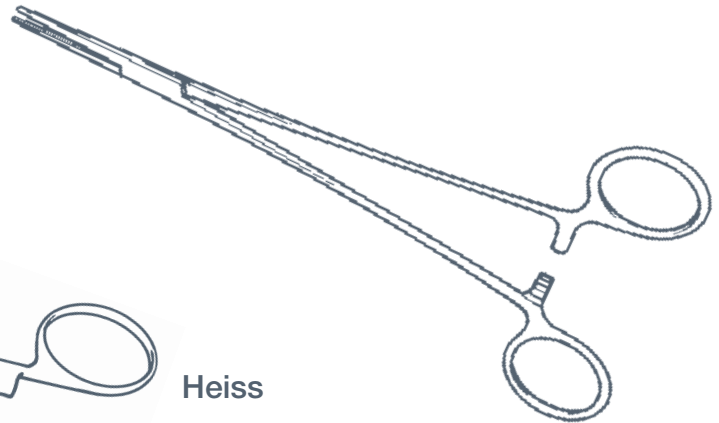

**Heiss**

straight  
1043/05 200mm  
slightly curved  
1043/10 200mm  
curved  
1043/15 200mm

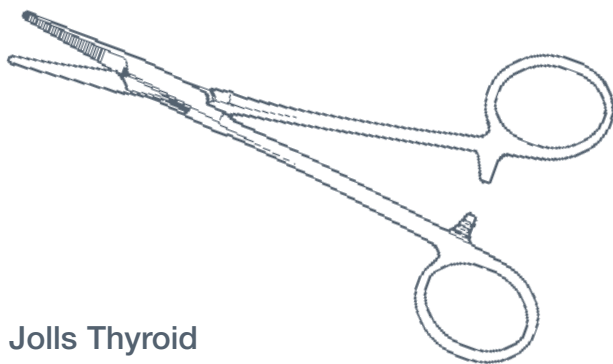
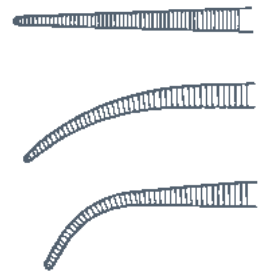

**Jolls Thyroid**

straight  
1044/25 150mm

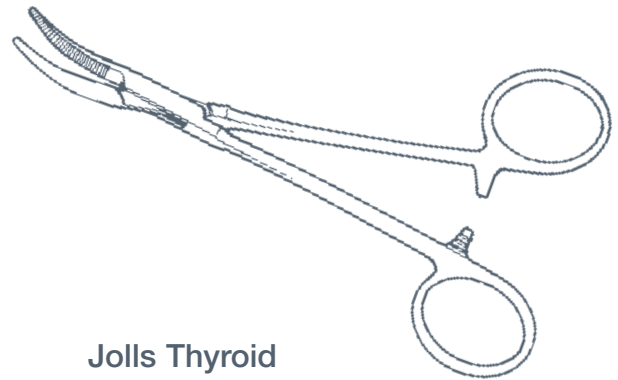

**Jolls Thyroid**

curved  
1044/50 150mm







### ARTERY FORCEPS

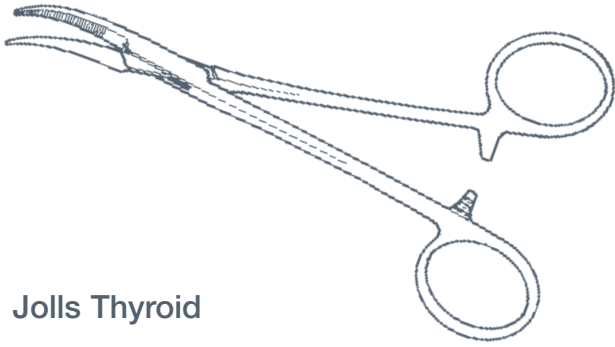

#### Jolls Thyroid

curved to side  
1044/75 150mm

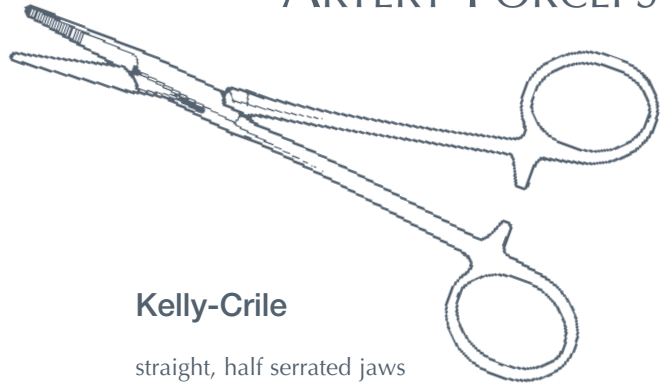

#### Kelly-Crile

straight, half serrated jaws  
1046/05 145mm  
1046/10 160mm



curved, half serrated jaws  
1047/05 145mm  
1047/10 160mm

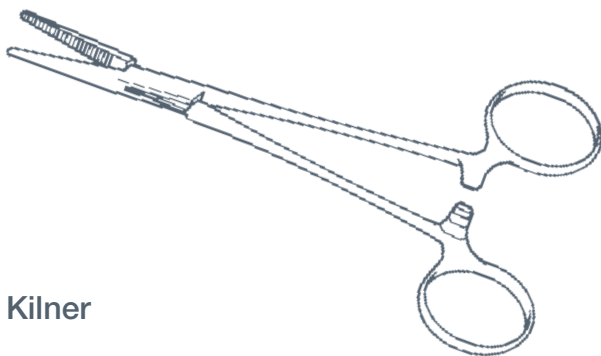

#### Kilner

straight, serrated jaws  
1050/05 140mm



curved, serrated jaws  
1051/05 140mm

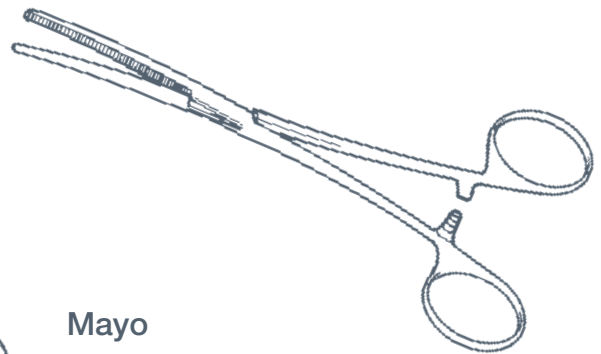

#### Mayo

curved  
1060/05 150mm

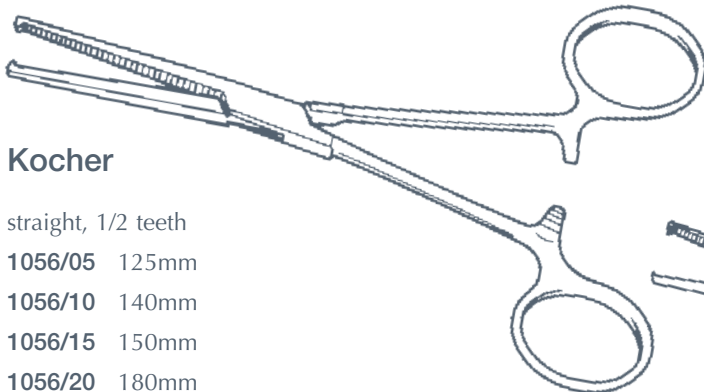

#### Kocher

straight, 1/2 teeth  
1056/05 125mm  
1056/10 140mm  
1056/15 150mm  
1056/20 180mm  
1056/25 200mm  
1056/30 230mm



curved, 1/2 teeth  
1057/05 125mm  
1057/10 140mm  
1057/15 150mm  
1057/20 180mm  
1057/25 200mm  
1057/30 230mm

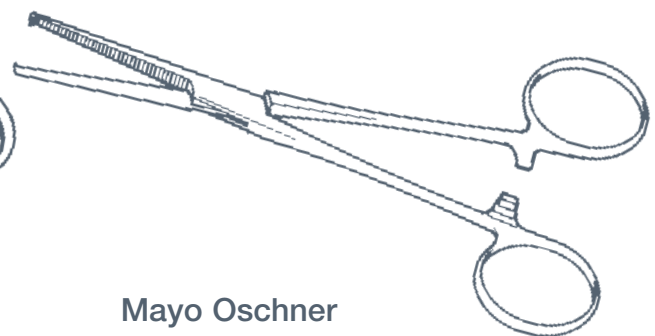

#### Mayo Oschner

straight  
1063/05 185mm  
curved  
1064/05 185mm





### ARTERY FORCEPS

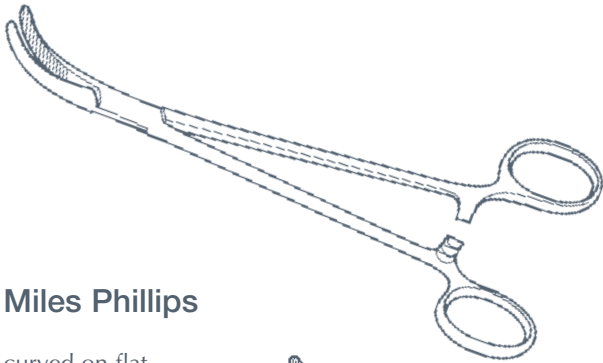

**Miles Phillips**

curved on flat

1067/05 180mm

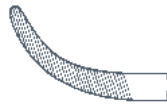

**Mixer Baby**

curved, half serrated jaws

1069/05 140mm

1069/10 180mm

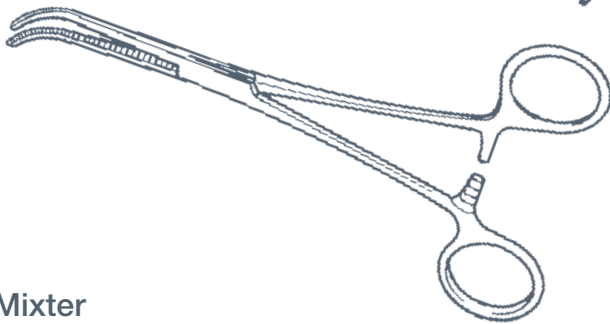

**Mixer**

curved, serrated jaws

1070/05 150mm

1070/10 180mm

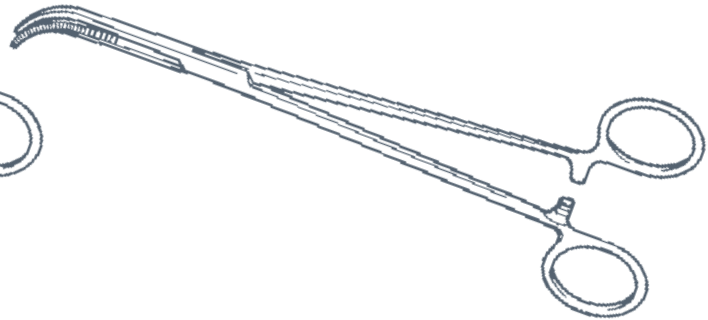

**Mixer**

curved, half serrated jaws

1070/15 220mm

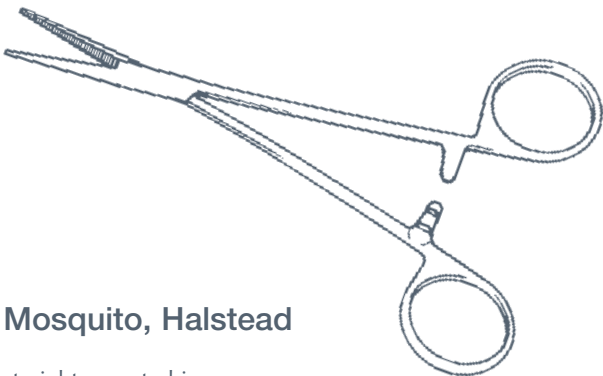

**Mosquito, Halstead**

straight, serrated jaws

1073/10 95mm

1073/15 125mm



curved, serrated jaws

1074/10 95mm

1074/15 125mm

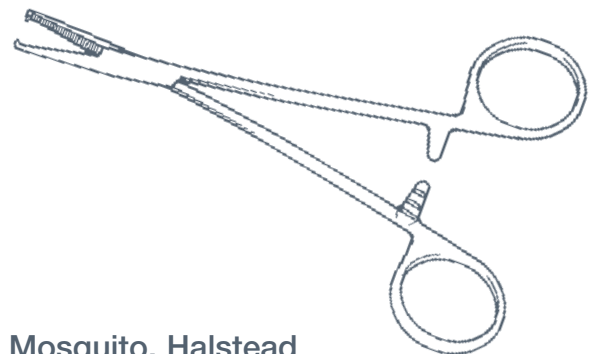

**Mosquito, Halstead**

straight, 1/2 teeth

1075/05 125mm



curved, 1/2 teeth

1076/05 125mm





## ARTERY FORCEPS

GEN

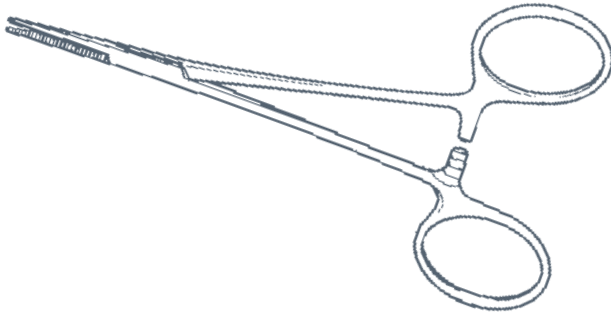

### Mosquito, Micro

straight

1078/05 120mm



curved

1079/05 120mm

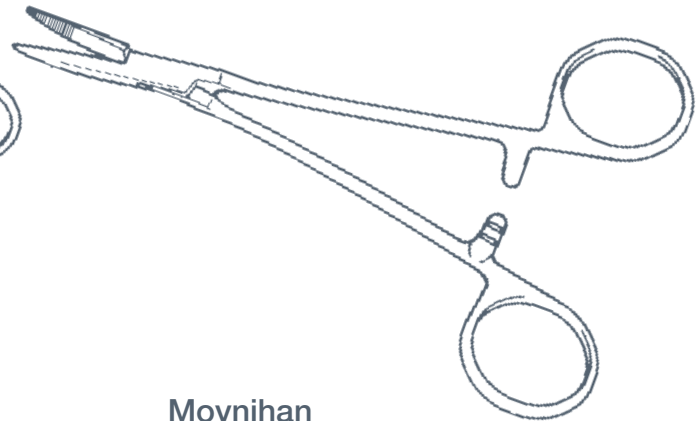

### Moynihan

straight, half serrated jaws

1082/05 145mm

1082/10 180mm



curved, half serrated jaws

1083/05 145mm

1083/10 180mm

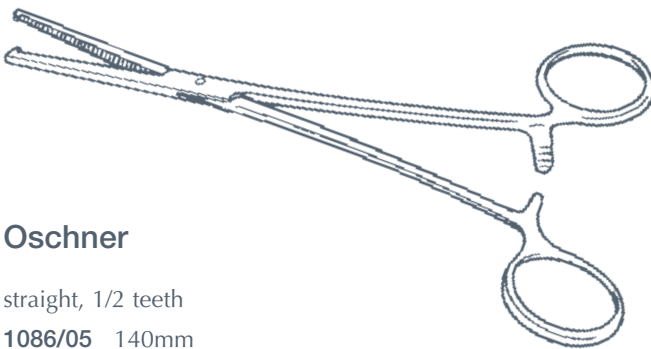

### Oschner

straight, 1/2 teeth

1086/05 140mm

1086/10 165mm

1086/15 180mm

1086/20 200mm

1086/25 220mm

1086/30 240mm

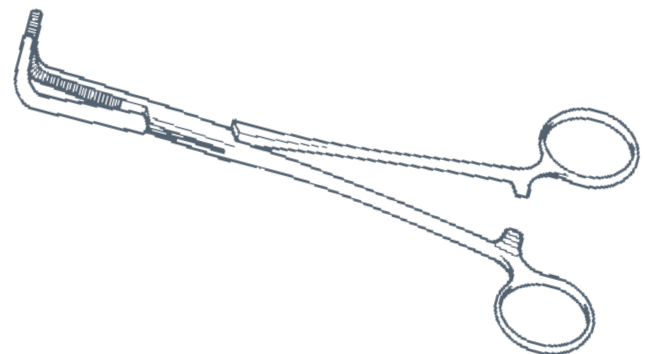

### O'Shaughnessy

curved

1090/05 150mm

1090/10 180mm

1090/15 200mm

1090/20 230mm



curved, 1/2 teeth

1087/05 140mm

1087/10 165mm

1087/15 180mm

1087/20 200mm

1087/25 220mm

1087/30 240mm





### ARTERY FORCEPS

#### Ronald Edwards

curved, screw joint  
1102/25 215mm shape A

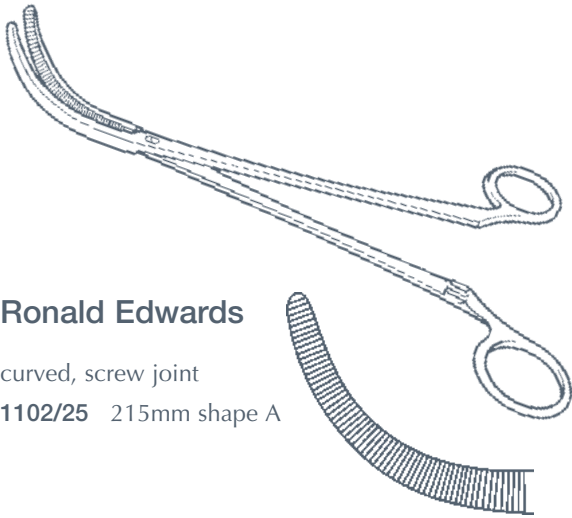

#### Ronald Edwards

curved, screw joint  
1102/50 215mm shape B

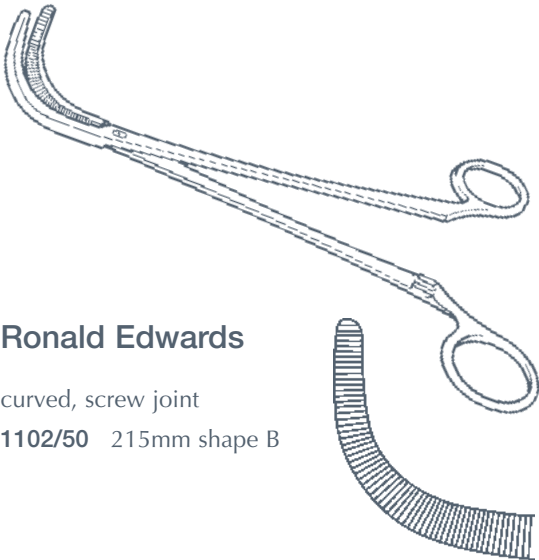

#### Ronald Edwards

curved, screw joint  
1102/75 215mm shape C

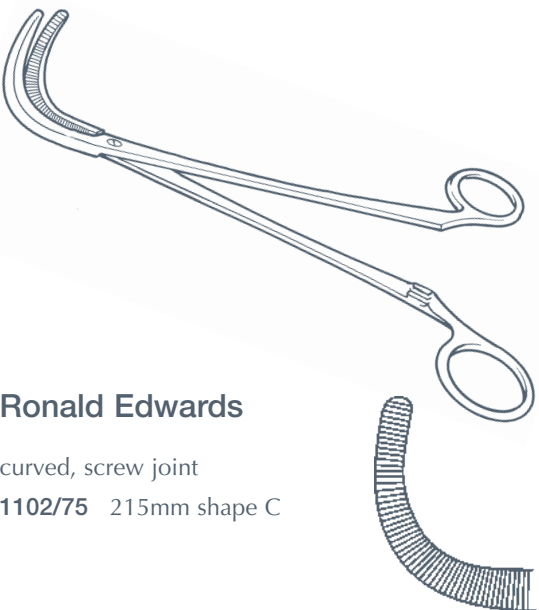

#### Rochester-Pean

straight

- 1097/05 140mm
- 1097/10 160mm
- 1097/15 180mm
- 1097/20 200mm
- 1097/25 220mm
- 1097/30 240mm
- 1097/35 260mm



curved

- 1098/05 140mm
- 1098/10 160mm
- 1098/15 180mm
- 1098/20 200mm
- 1098/25 220mm
- 1098/30 240mm
- 1098/35 260mm

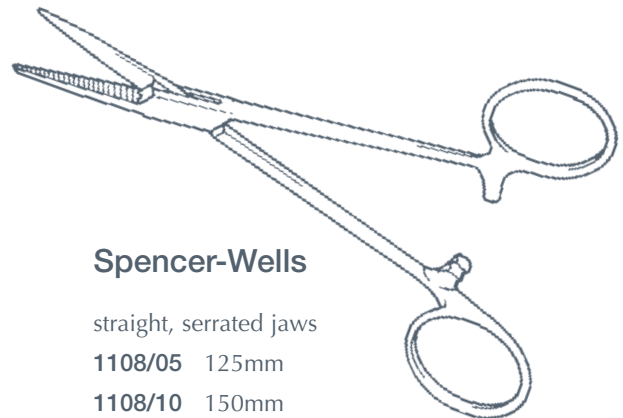
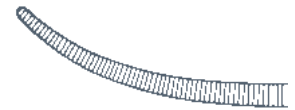

#### Spencer-Wells

straight, serrated jaws

- 1108/05 125mm
- 1108/10 150mm
- 1108/15 180mm
- 1108/20 200mm
- 1108/25 230mm



curved, serrated jaws

- 1109/05 125mm
- 1109/10 150mm
- 1109/15 180mm
- 1109/20 200mm
- 1109/25 230mm





## BANDAGE

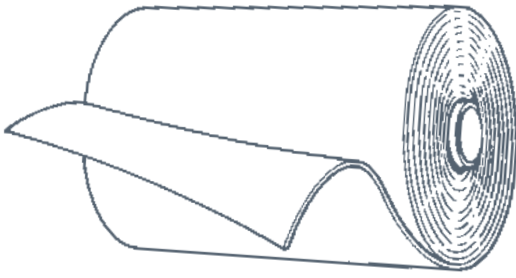

### Esmarch

rubber

1112/05 3.0metres x 76mm

1112/10 5.5metres x 76mm

## BRUSH



### Wire

for cleaning instruments

1120/05 280mm

## CHOLECYSTECTOMY FORCEPS

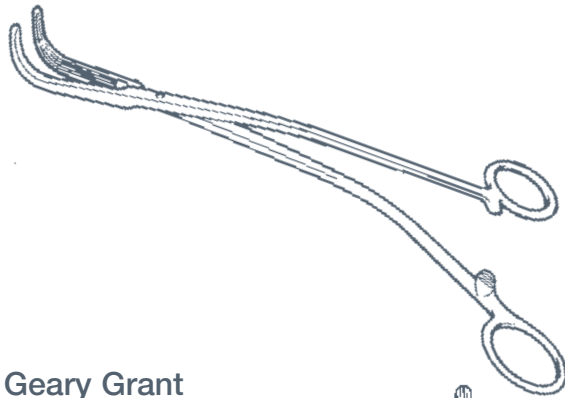

### Geary Grant

small, non-toothed jaws, longitudinal serrations 230mm

1121/05

large, non-toothed jaws, longitudinal serrations 230mm

1121/10

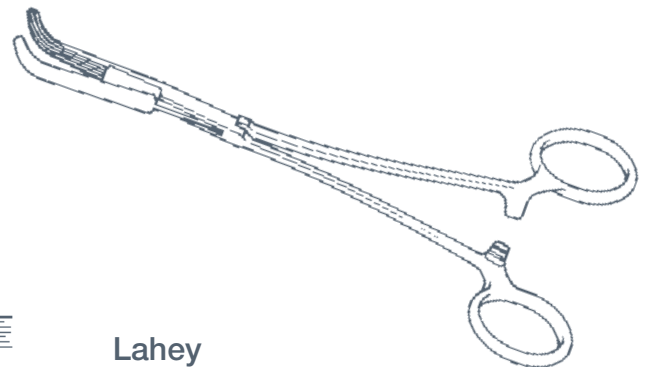

### Lahey

curved, longitudinal serrations

1124/05 195mm

1124/10 230mm



### Moynihhan

curved on flat, box joint

1127/05 215mm

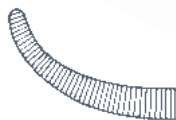
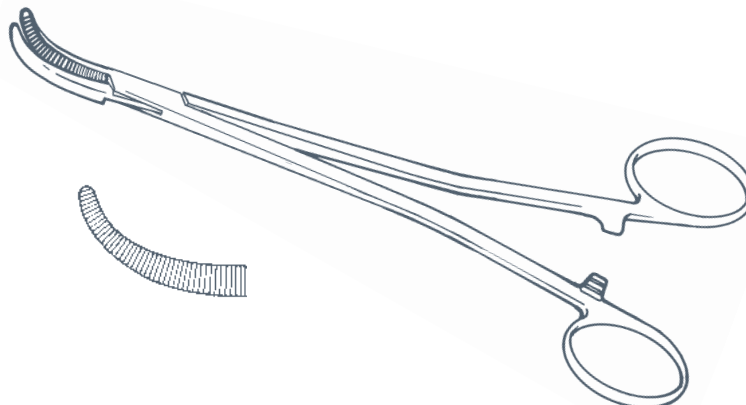



### CLAMPS

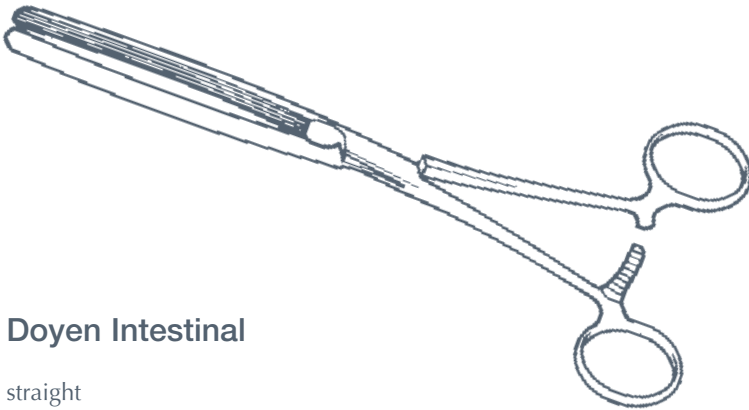

#### Doyen Intestinal

straight

**1134/05** 180mm

**1134/10** 230mm



curved

**1135/05** 180mm

**1135/10** 230mm

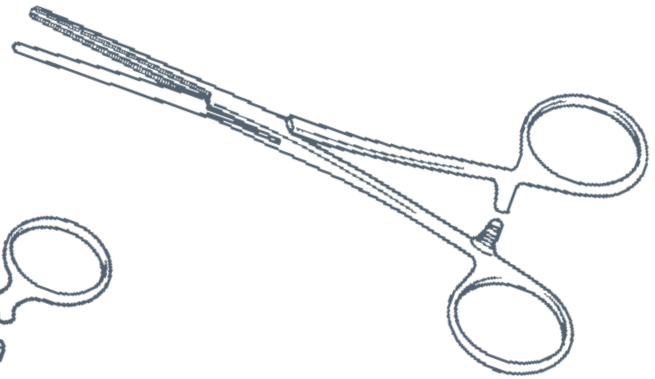
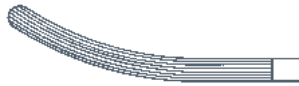

#### Fergusson Angiotribe

straight

**1138/05** 165mm

**1138/10** 200mm



curved

**1139/05** 165mm

**1139/10** 200mm



#### Kocher Intestinal

straight, longitudinal serrations,  
light spring blades

**1141/05** 225mm, 100mm blades

**1141/10** 250mm, 125mm blades

**1141/15** 275mm, 150mm blades



curved, longitudinal serrations,  
light spring blades

**1142/05** 225mm, 100mm blades

**1142/10** 250mm, 125mm blades

**1142/15** 275mm, 150mm blades

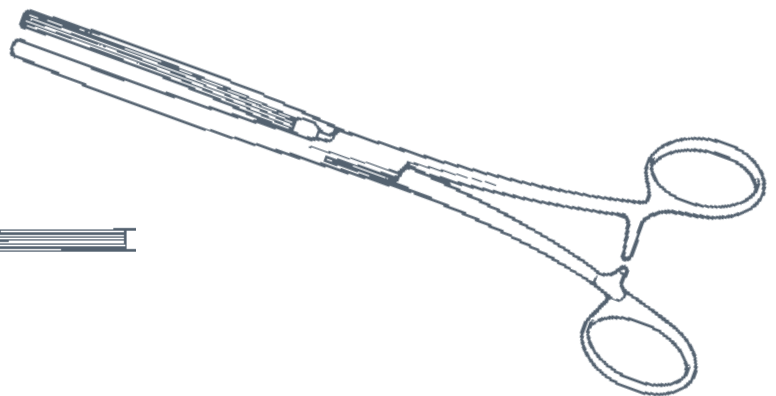

#### Lanes Intestinal

straight, longitudinal serrations

**1145/05** 215mm, 75mm blades

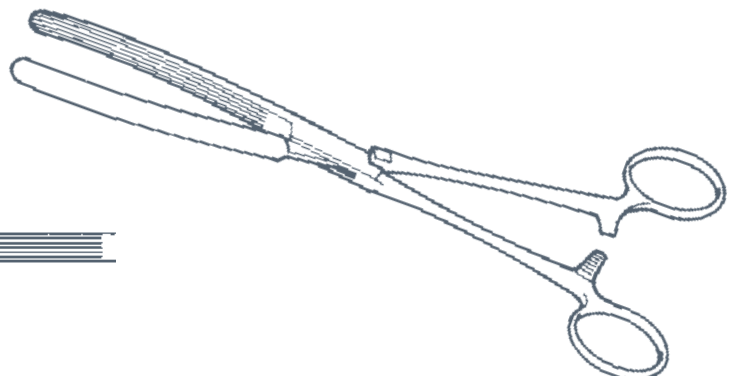



## CLAMPS

GEN

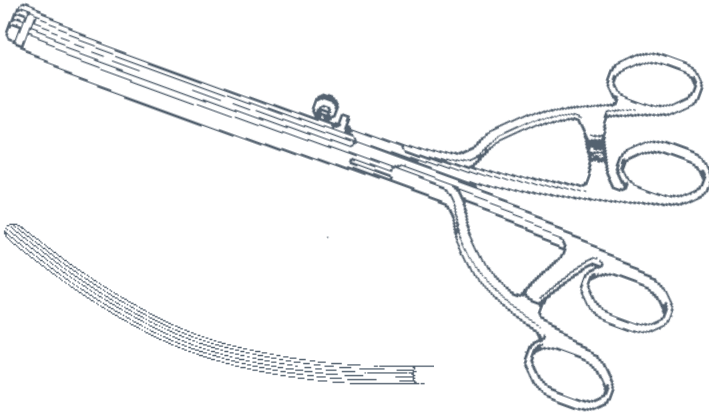

### Lanes Twin

straight, longitudinal serrations

1148/05 305mm

curved, longitudinal serrations

1149/05 305mm

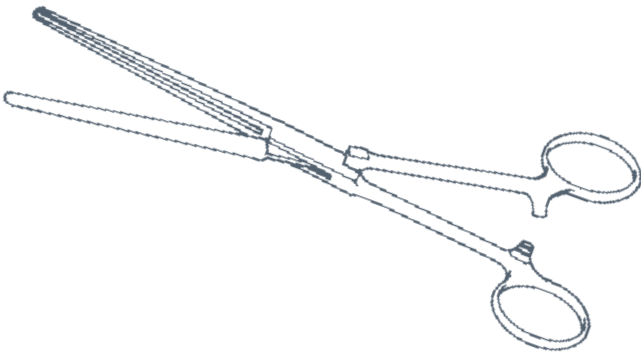

### Lang Stevenson

keyed blades

1152/05 200mm, 80mm blades

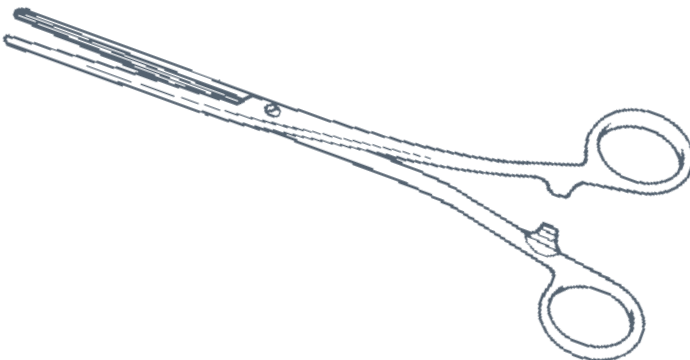

### Parker Kerr

straight, screw joint

1155/05 230mm

1155/10 255mm

curved, screw joint

1156/05 230mm

1156/10 255mm





### CLAMPS

#### Payr

crushing, lever action, longitudinal serrations

1159/05 150mm, 50mm blades

1159/10 210mm, 65mm blades

1159/15 255mm, 100mm blades

1159/20 350mm, 150mm blades

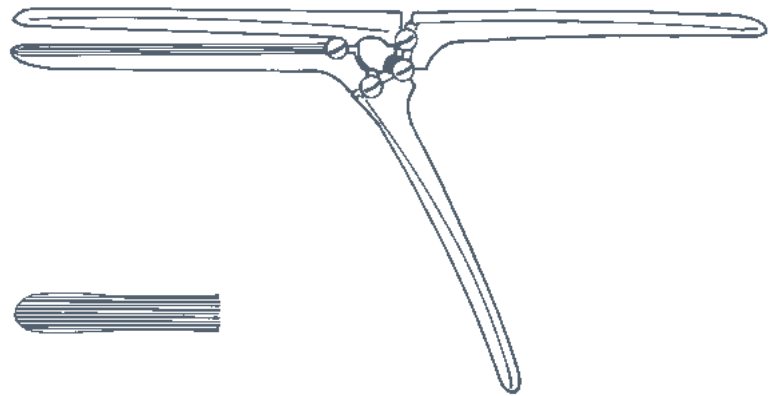

#### Schoemaker-Ogilvie

straight for hemisphincterectomy,  
hollow blades

1162/05 170mm

1162/10 215mm

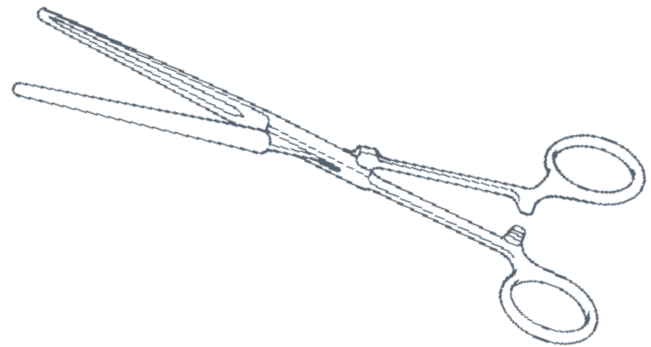

### CLAMPS, ATRAUMATIC

#### Doyen

straight

1174/15 180mm

1174/25 230mm

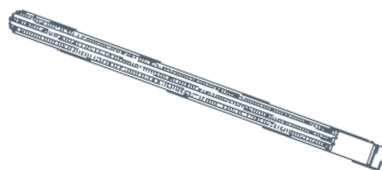

curved

1175/15 180mm

1175/25 230mm

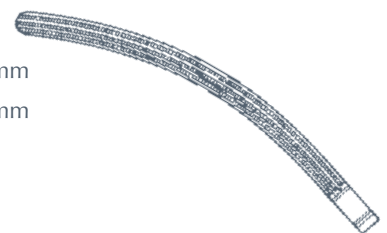





## CLIP FORCEPS

GEN

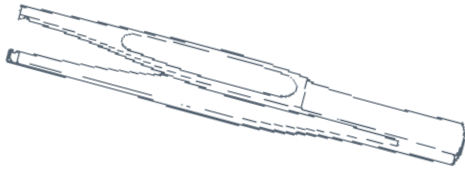

### Comyns Berkeley

applying, serrated jaws 140mm  
1178/05

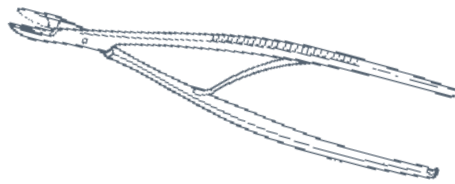

### Michel

applying and extracting combined 125mm  
1183/05

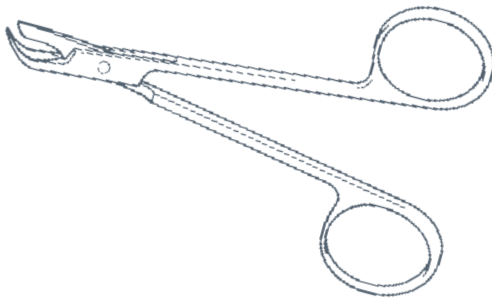

clip extracting 120mm  
1185/05

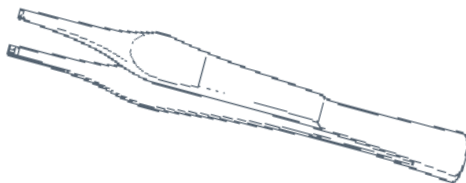

applying 125mm  
1188/05

## DIATHERMY



### Cable

red rubber covered  
1204/05 3 metres  
1204/10 5 metres



### DIATHERMY

#### Carrier



for ball and plate electrodes

1207/05 straight

#### Electrode

ball, silver

1213/05 5mm

1213/10 8mm



#### Handle

for knife electrode and electrode carrier

1215/05



#### Handle

for loops and needles

1216/05

#### Loops

fine (30swg)

1222/05 8mm

1222/10 10mm

1222/15 12mm

1222/20 14mm



stout (25swg)

1223/05 8mm

1223/10 10mm

1223/15 12mm



#### Quiver

plastic with ring 200mm x 65mm

1231/05

telescopic, extends to 400mm x 65mm

1231/25

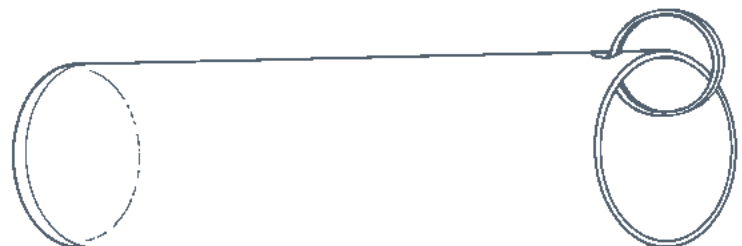

#### Carrier

for ball and plate electrodes

1208/05 curved

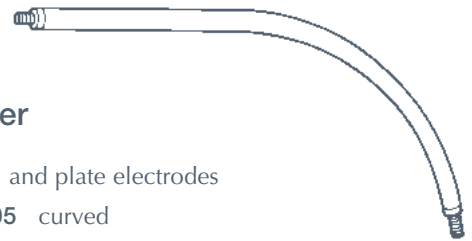

#### Electrode

plate, silver

1213/55 8mm

1213/60 10mm



#### Knife Electrode

Monel metal blade 50mm

1219/05



#### Needles

fine (25swg)

1226/05 short 20mm

1226/10 long 32mm

1226/15 angled 30mm

medium (22swg)

1227/05 short 20mm

1227/10 long 32mm

1227/15 angled 30mm

stout (19swg)

1228/05 short 20mm

1228/10 long 32mm

1228/15 angled 30mm





### DIATHERMY FORCEPS

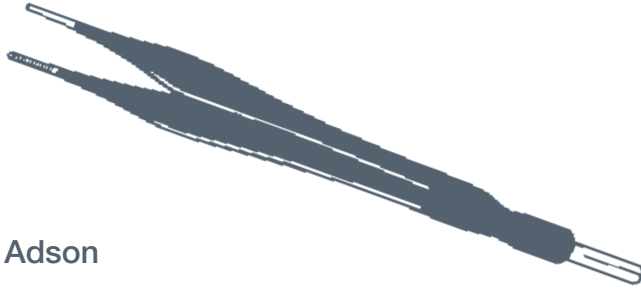

#### Adson

serrated

1237/05 125mm

1237/10 180mm



#### Adson

1/2 teeth

1238/05 125mm

1238/10 180mm



#### Dissecting

serrated

1244/05 100mm

1244/10 150mm

1244/15 180mm

1244/20 200mm

1244/25 240mm



#### Dissecting

1/2 teeth

1247/05 100mm

1247/10 150mm

1247/15 180mm

1247/20 200mm

1247/25 240mm

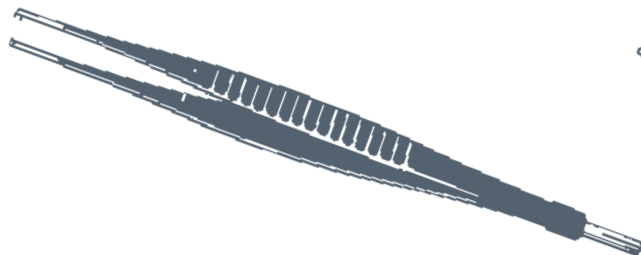

#### Gillies

1/2 teeth

1250/05 150mm



#### McIndoe

serrated

1253/05 150mm





### DIATHERMY FORCEPS

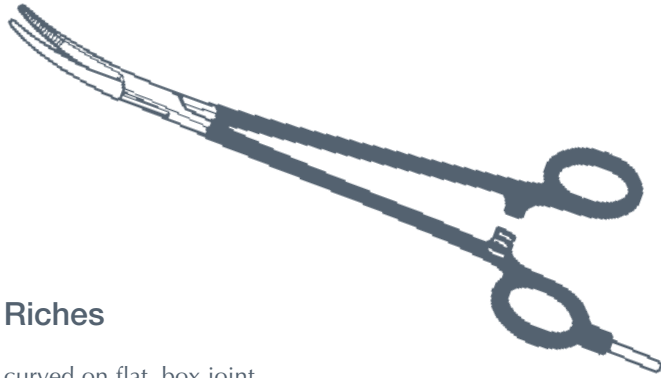

**Riches**

curved on flat, box joint

1256/05 145mm

1256/10 200mm

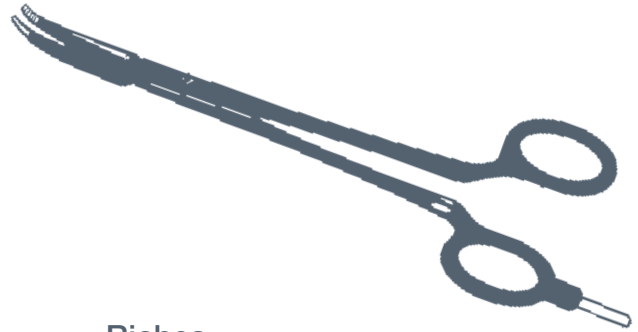

**Riches**

curved on flat, screw joint

1257/05 125mm

1257/10 150mm

1257/15 180mm

1257/20 200mm

1257/25 230mm

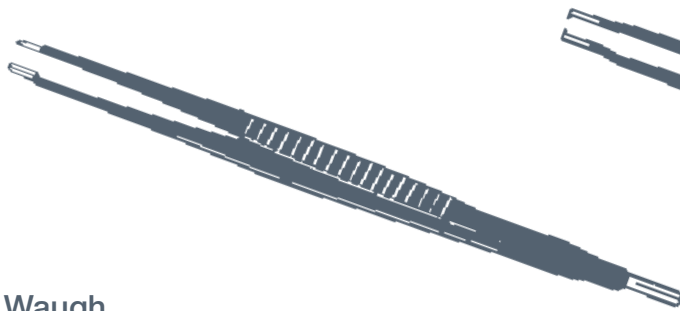

**Waugh**

serrated

1260/05 180mm

1260/10 200mm

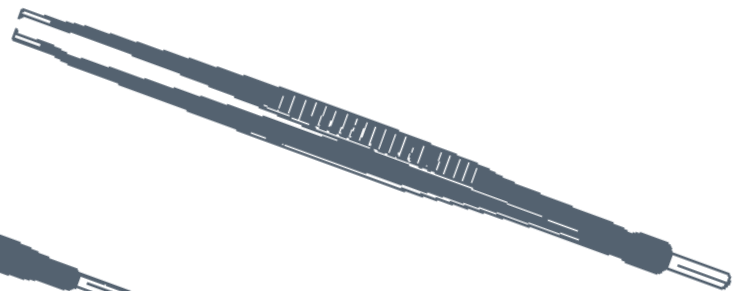

**Waugh**

1/2 teeth

1261/05 180mm

1261/10 200mm

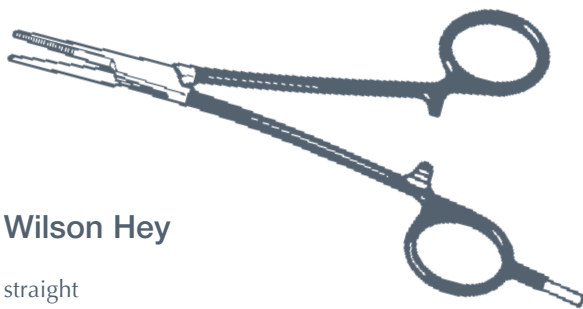

**Wilson Hey**

straight

1267/05 145mm

1267/10 180mm

1267/15 230mm

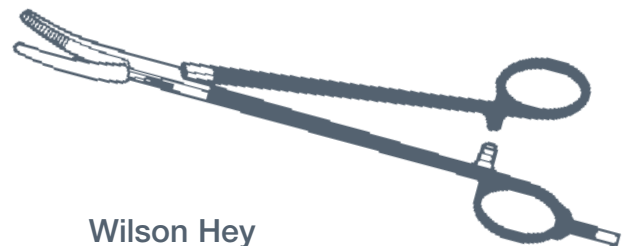

**Wilson Hey**

curved

1268/05 145mm

1268/10 180mm

1268/15 230mm





### DIATHERMY SCISSORS



#### Turner-Warwick

straight

- 1271/05 180mm
- 1271/10 215mm
- 1271/15 240mm



#### Turner-Warwick

curved

- 1272/05 180mm
- 1272/10 215mm
- 1272/15 240mm

### DISSECTING FORCEPS

#### Adson

serrated

- 1281/25 125mm

serrated, fine

- 1281/50 125mm
- 1281/55 180mm

serrated, ultra light

- 1281/75 180mm

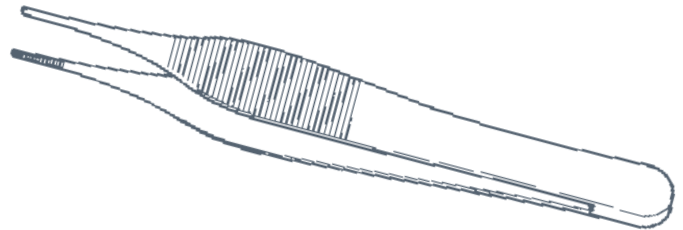

#### Adson

1/2 teeth



- 1282/25 125mm

1/2 teeth, fine



- 1282/50 125mm
- 1282/55 180mm

1/2 teeth, ultra light



- 1282/75 180mm

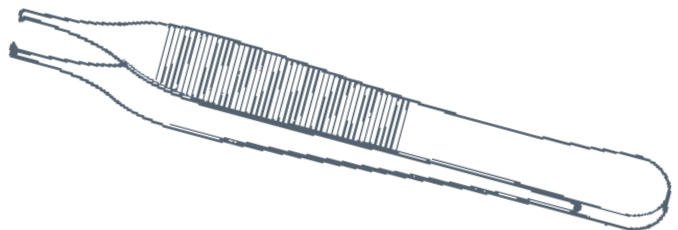

#### Bickford

serrated

- 1283/05 230mm

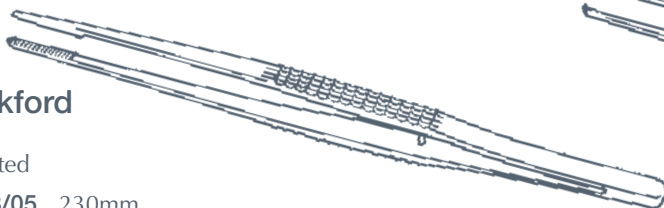

1/2 teeth



- 1284/05 230mm

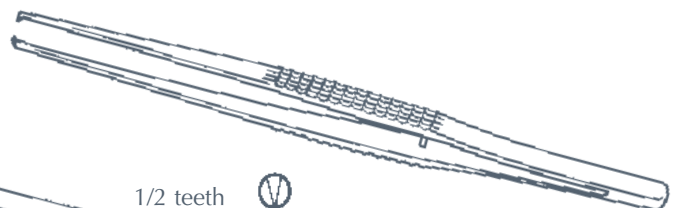



### DISSECTING FORCEPS

#### Block End

fine serrated jaws, narrow flutes

- 1290/05 150mm
- 1290/10 180mm
- 1290/15 200mm

round serrated jaws, narrow flutes

- 1292/03 125mm
- 1292/05 150mm
- 1292/10 180mm
- 1292/15 200mm
- 1292/20 250mm

serrated jaws, broad flutes

- 1294/05 125mm
- 1294/10 150mm
- 1294/15 180mm
- 1294/20 200mm
- 1294/25 250mm
- 1294/30 300mm

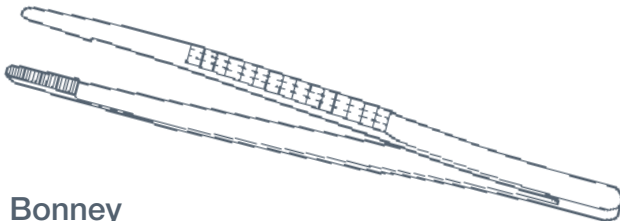
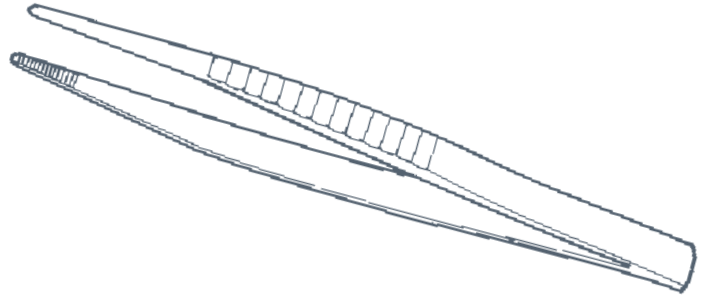
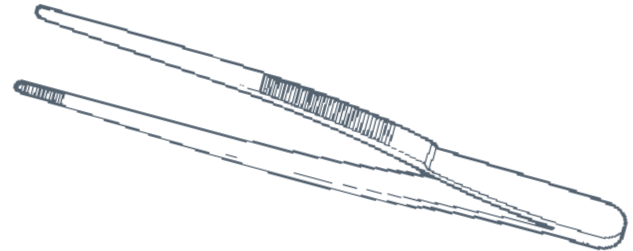
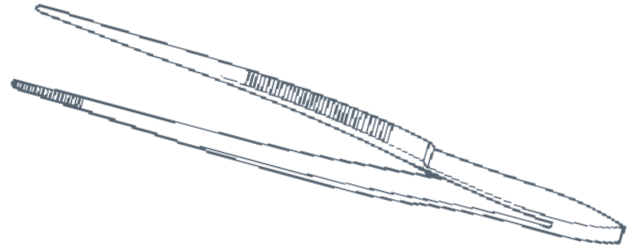

#### Bonney

serrated

- 1301/25 180mm

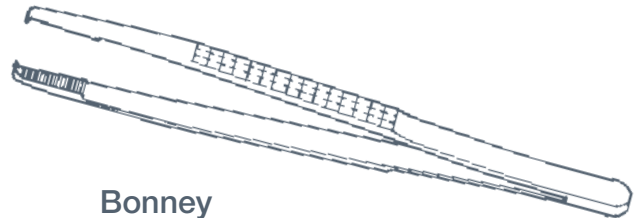

#### Bonney

1/2 teeth



- 1301/50 180mm

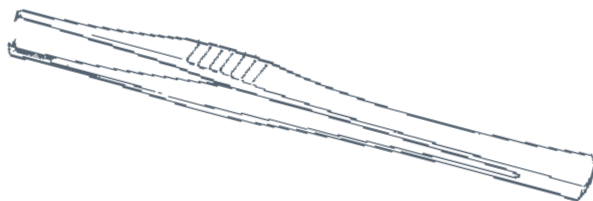

#### Braithwaite

1/2 teeth



- 1303/05 140mm

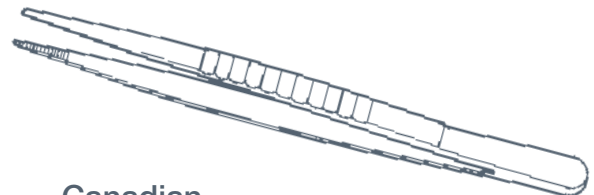

#### Canadian

serrated jaws

- 1304/05 140mm
- 1304/10 150mm



### DISSECTING FORCEPS

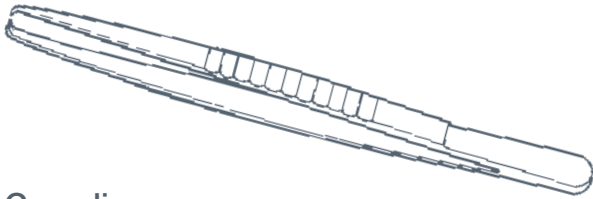

#### Canadian

2/3 teeth



1305/05 140mm

1305/10 150mm

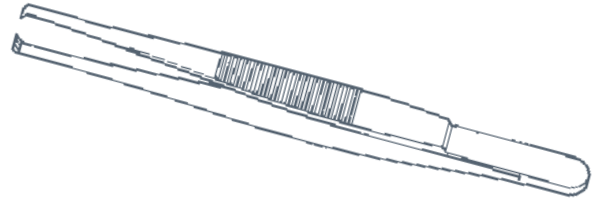

#### Continental Pattern

1/2 teeth



1308/05 105mm

1308/15 125mm

1308/25 150mm

1308/30 160mm

1308/35 175mm

1308/40 200mm

1308/45 250mm

1308/50 300mm

2/3 teeth



1310/05 125mm

1310/10 150mm

1310/15 160mm

1310/20 175mm

1310/25 200mm

1310/30 250mm

1310/35 300mm

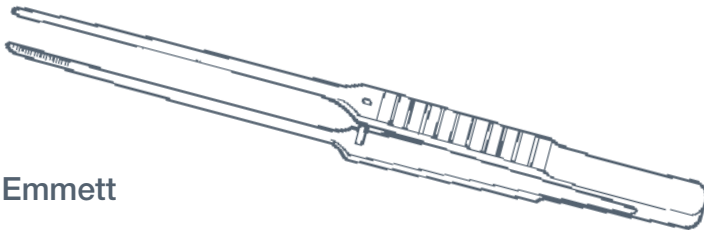

#### Emmett

serrated jaws

1315/05 200mm

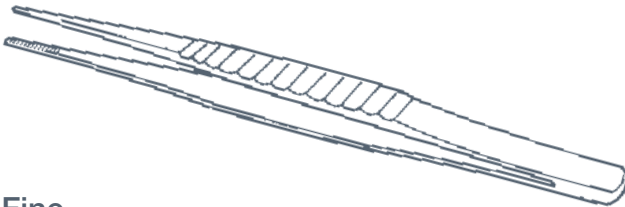

#### Fine

serrated

1316/05 125mm

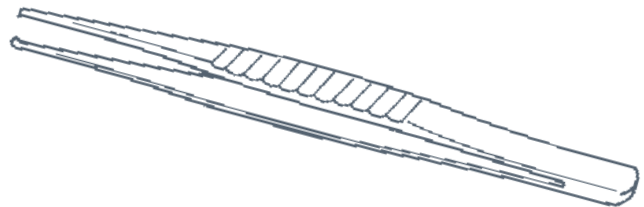

#### Fine

1/2 teeth



1317/05 125mm

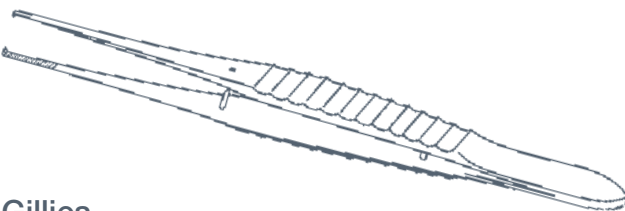

#### Gillies

1/2 teeth



1318/05 150mm

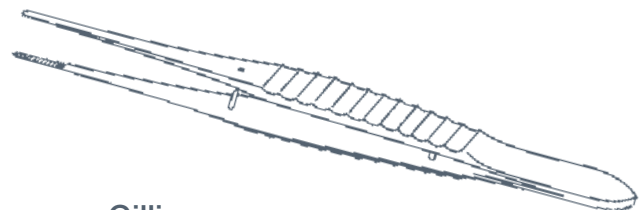

#### Gillies

serrated

1318/20 150mm



### DISSECTING FORCEPS

#### Iris

straight, serrated

1319/05 90mm

1319/10 115mm

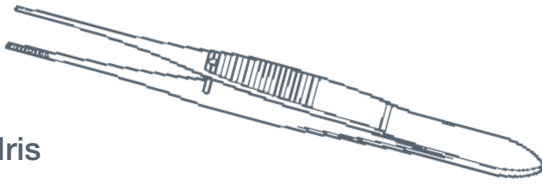

#### Iris

straight, 1/2 teeth 

1320/05 90mm

1320/10 115mm

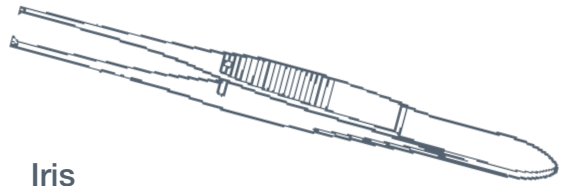

#### Jeans

serrated jaws

1321/05 140mm

1/2 teeth 

1322/05 140mm

1322/10 180mm

2/3 teeth 

1323/10 180mm

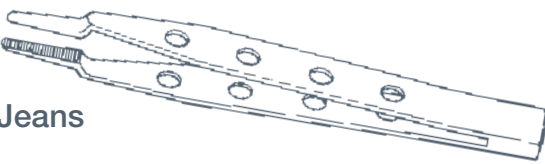

#### Lanes

1/2 teeth 

1326/05 125mm

1326/10 140mm

1326/15 180mm

1326/20 200mm

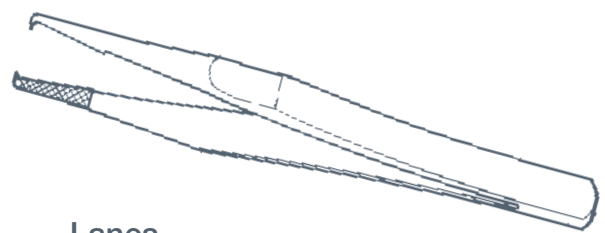

#### Lanes

2/3 teeth 

1327/05 125mm

1327/10 140mm

1327/15 180mm

1327/20 200mm

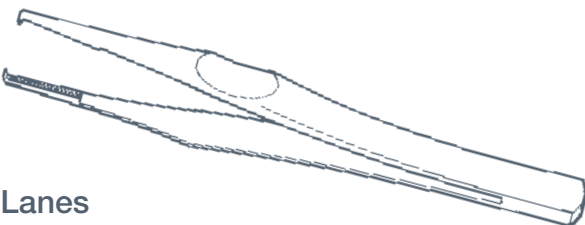

#### Leedham Green

1329/25 2/3 teeth, 145mm

1329/50 3/4 teeth, 145mm

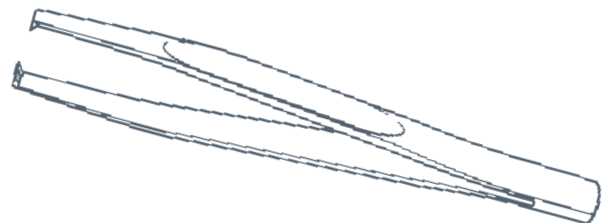

#### McIndoe

serrated

1334/25 150mm

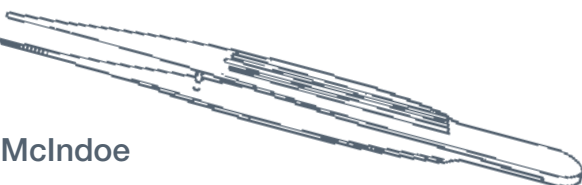

#### McIndoe

1/2 teeth 

1334/50 150mm

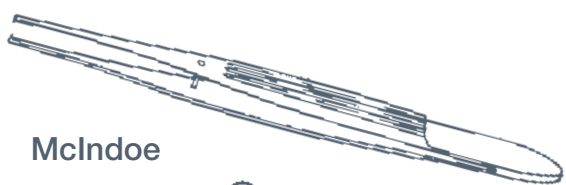





## DISSECTING FORCEPS

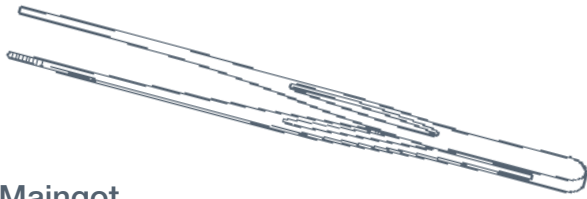

### Maingot

serrated tips, fenestrated grip  
1337/05 280mm

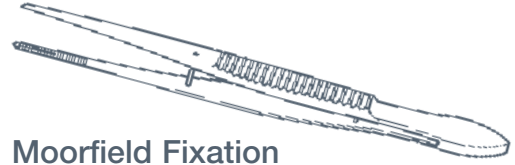

### Moorfield Fixation

fine points  
1339/05 90mm

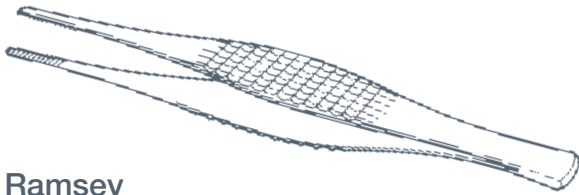

### Ramsey

serrated  
1344/05 180mm

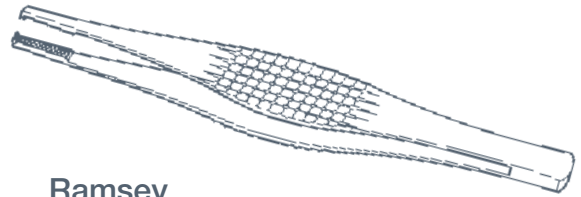

### Ramsey

1/2 teeth   
1345/05 180mm

2/3 teeth   
1346/05 180mm

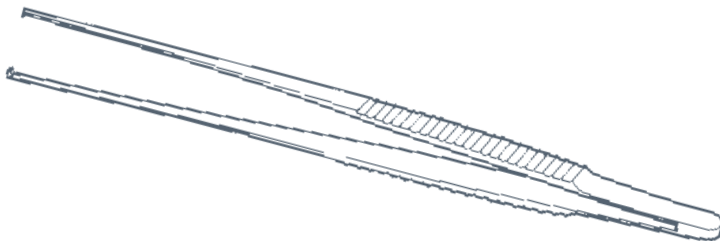

### St Marks Hospital

serrated  
1352/05 290mm

1/2 teeth   
1353/05 290mm

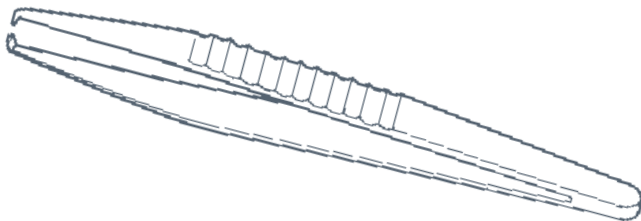

### Treves

1/2 teeth   
1360/05 125mm  
1360/10 150mm  
1360/15 180mm  
1360/20 200mm  
1360/25 250mm

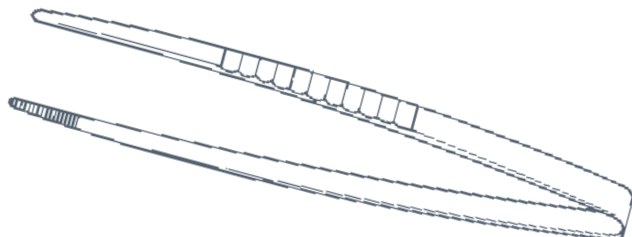

### Turn-Over-End

serrated jaws, broad flutes  
1363/05 125mm  
1363/10 150mm



## DISSECTING FORCEPS

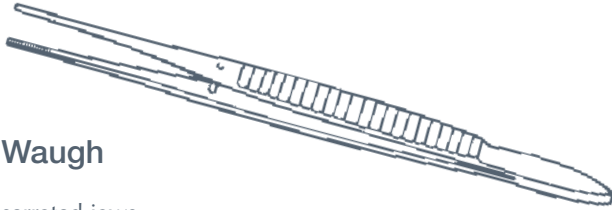

### Waugh

serrated jaws

1366/05 150mm

1366/08 180mm

1366/10 200mm

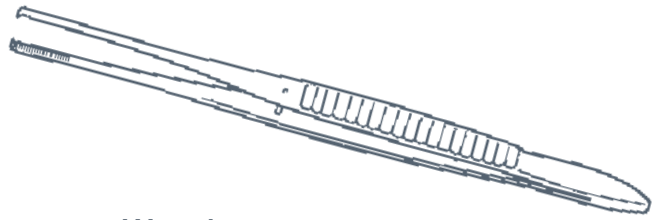

### Waugh

1/2 teeth



1367/05 150mm

1367/08 180mm

1367/10 200mm

## DISSECTORS

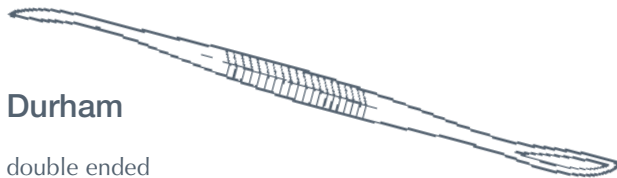

### Durham

double ended

1382/05 190mm

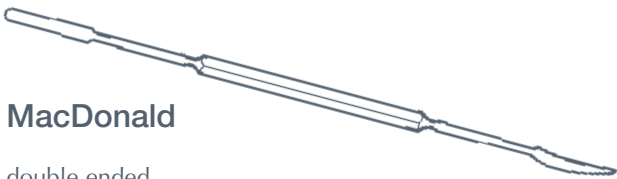

### MacDonald

double ended

1388/05 190mm

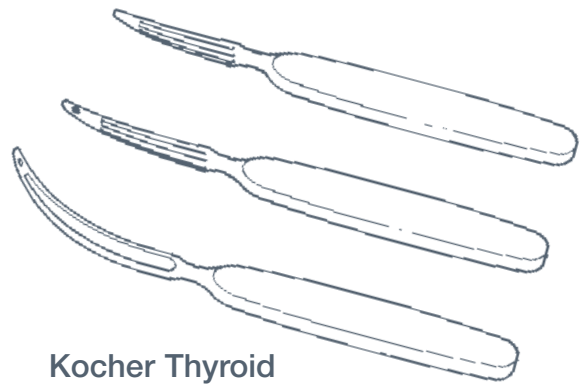

### Kocher Thyroid

curved

1385/05 160mm

1385/10 165mm

1385/15 180mm

### Watson Cheyne

fine with probe

1391/05 125mm

1391/10 180mm

1391/15 230mm

1391/20 255mm



## DRESSING FORCEPS

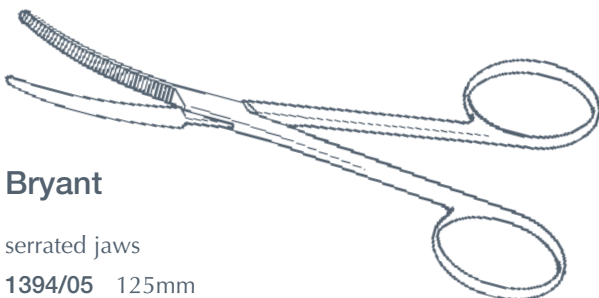

### Bryant

serrated jaws

1394/05 125mm

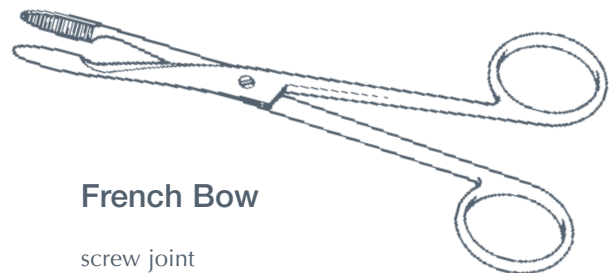

### French Bow

screw joint

1398/05 125mm

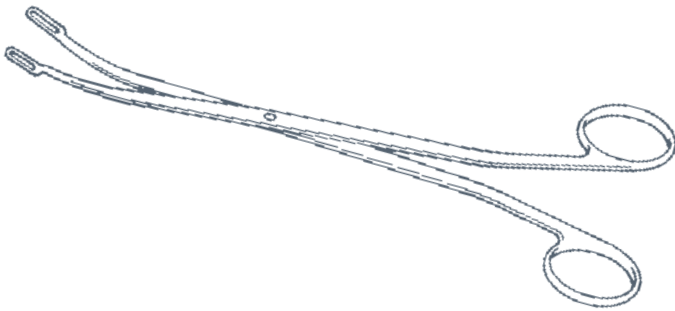

**Desjardins**

screw joint

1417/05 small, 220mm

1417/10 large, 240mm



GALLSTONE FORCEPS

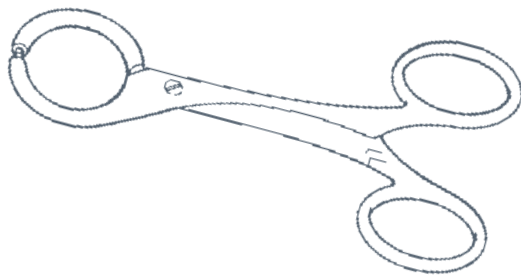

HERNIA FORCEPS

**Collingwood Stewart**

ring bladed, screw joint

1433/05 140mm

INSTRUMENT PINS

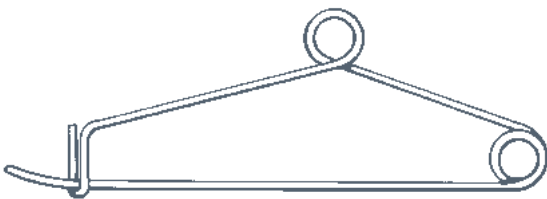

**Mayo**

plain, made in Pakistan

1436/05 100mm

1436/10 150mm

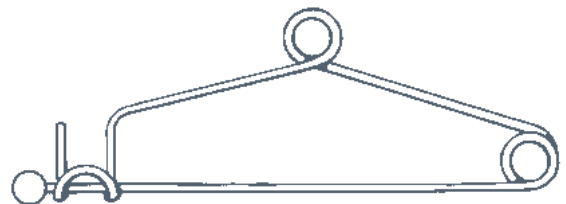

**Mayo**

with ball end, made in Pakistan

1437/05 100mm

1437/10 150mm

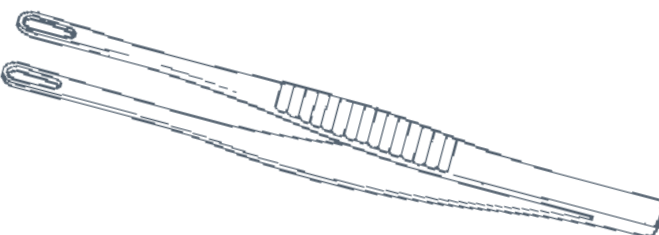

INTESTINAL FORCEPS

**Denis Brown**

1439/05 190mm



## INTRODUCING FORCEPS

### Magill

screw joint

1440/05 adult, 230mm

1440/10 child, 190mm

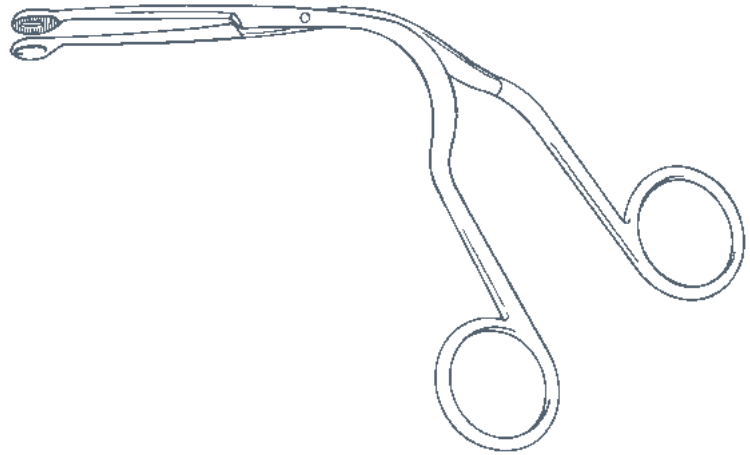

## KNIVES

### Brain

solid forged

1445/05 200mm blade

1445/10 225mm blade

1445/15 250mm blade

1445/20 300mm blade

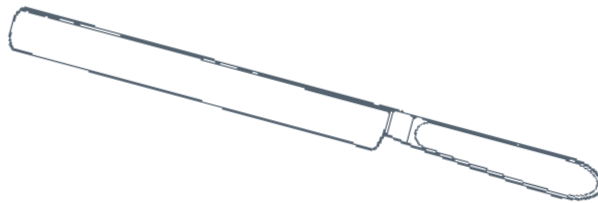

### Cartilage

solid forged

1448/05 200mm, 70mm blade

1448/10 215mm, 90mm blade

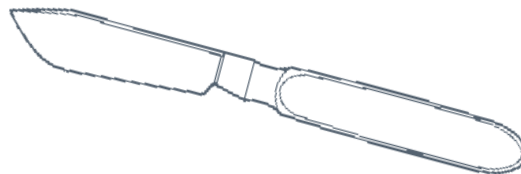

### Catlin

solid forged

1451/05 245mm, 120mm blade

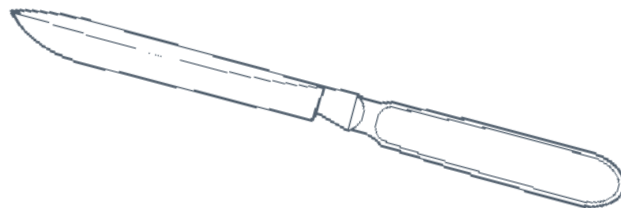

### Liston Amputation

solid forged

1454/05 100mm blade

1454/10 125mm blade

1454/15 150mm blade

1454/20 180mm blade

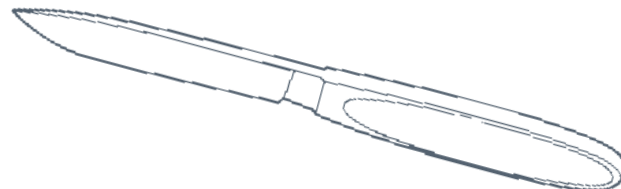

### Paget

1455/05 140mm

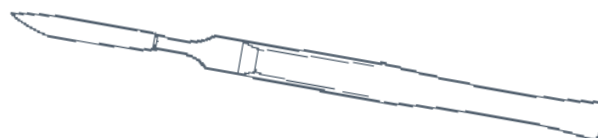



## MOUTH GAGS

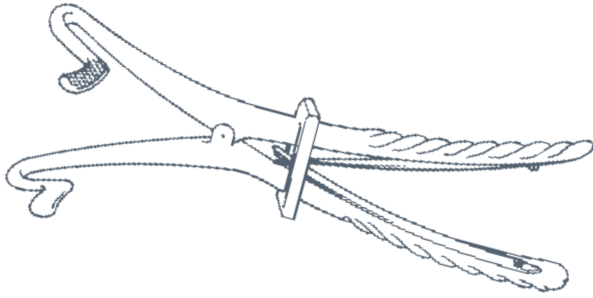

### Fergusson

Ackland jaw

1482/05 adult, 200mm

1482/10 child, 170mm

ordinary jaw

1483/05 adult, 200mm

1483/10 child, 170mm

## NEEDLEHOLDERS

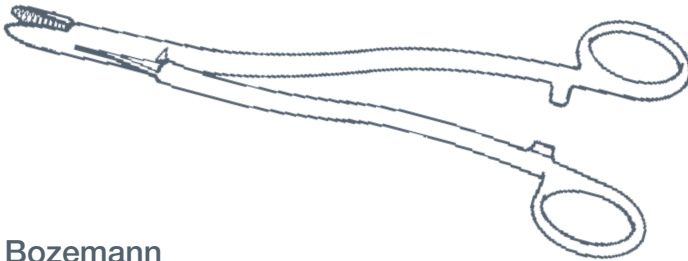

### Bozemann

double curve, serrated jaws

1490/05 200mm

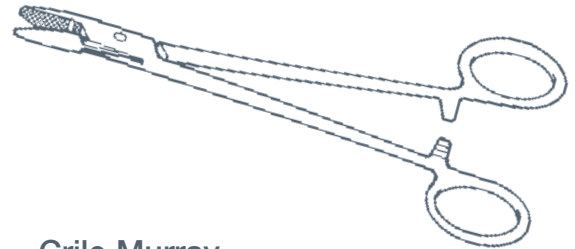

### Crile Murray

serrated jaws

1493/05 145mm

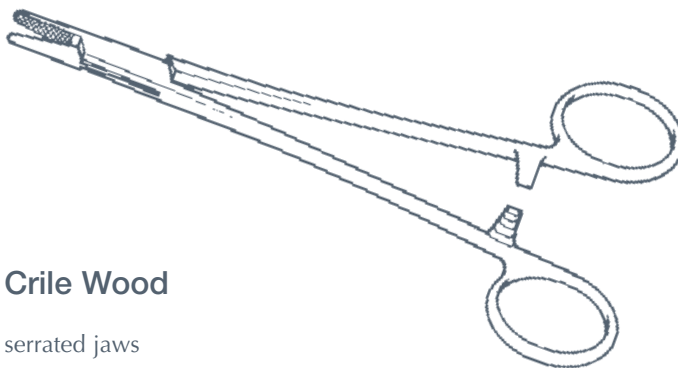

### Crile Wood

serrated jaws

1496/05 150mm

1496/10 180mm

1496/15 200mm

1496/20 230mm

1496/25 255mm

1496/30 305mm

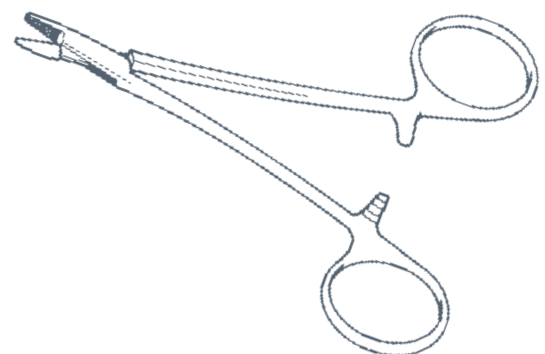

### Derf

serrated jaws

1497/05 120mm





### NEEDLEHOLDERS

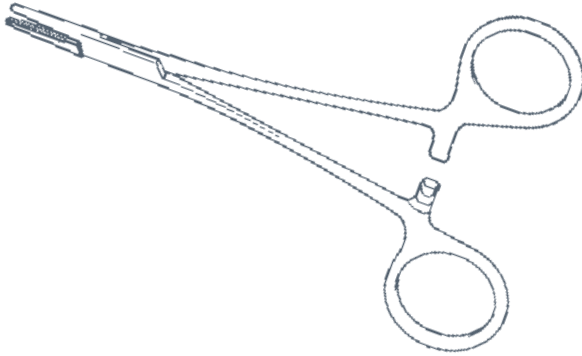

**Halsey**

serrated jaws  
1499/05 125mm

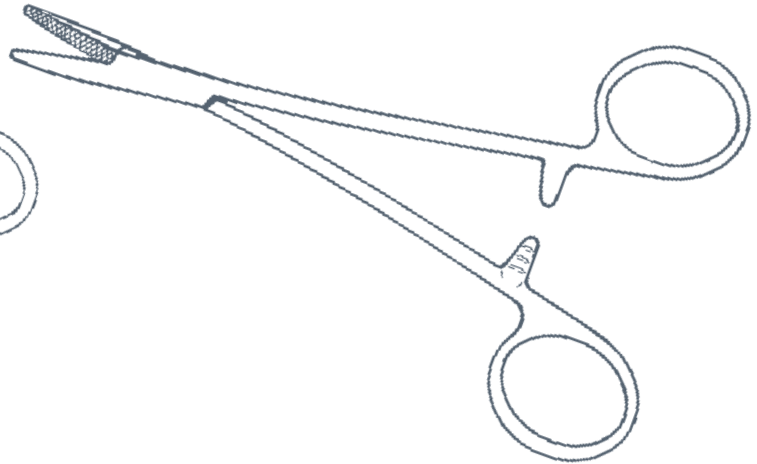

**Hegar**

serrated jaws  
1505/05 200mm

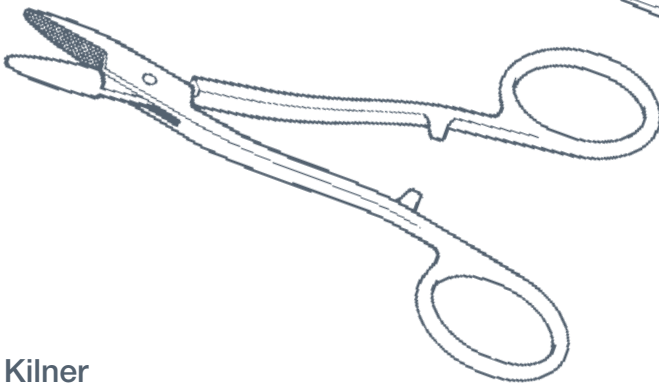

**Kilner**

serrated jaws  
1508/05 135mm  
1508/10 165mm

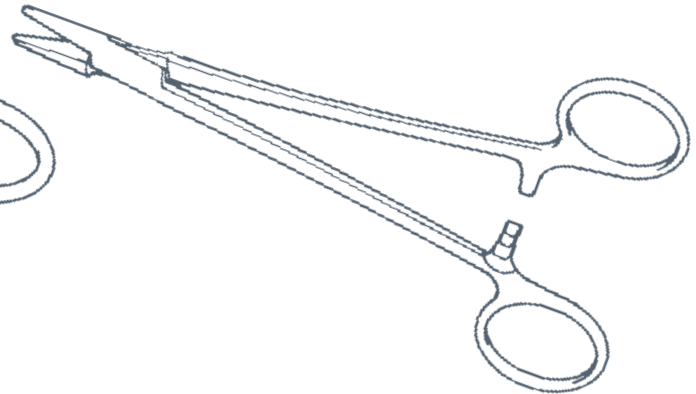

**Lawrance**

lightweight, serrated jaws  
1511/05 150mm

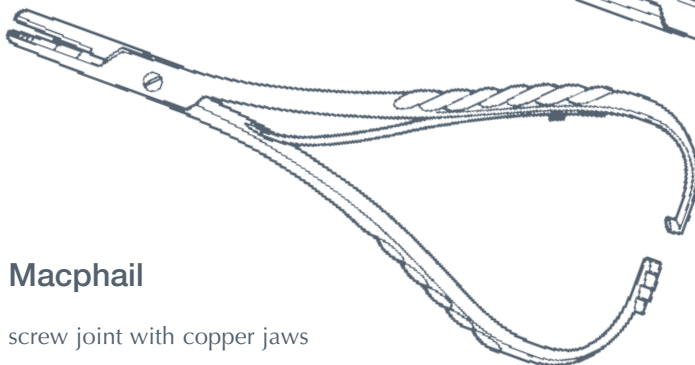

**Macphail**

screw joint with copper jaws  
1514/05 150mm  
1514/10 180mm  
1514/15 200mm

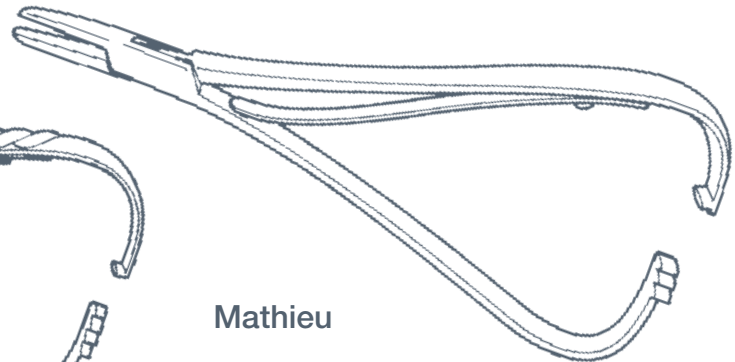

**Mathieu**

serrated jaws  
1517/05 170mm  
1517/10 200mm





### NEEDLEHOLDERS

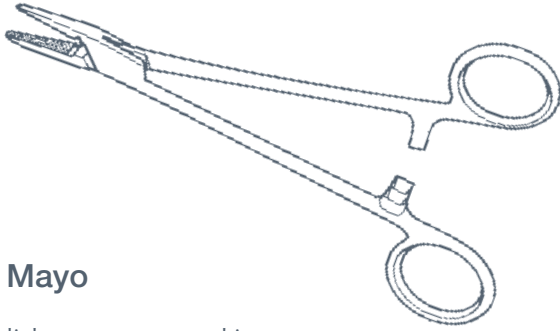

#### Mayo

light pattern, serrated jaws  
1520/05 150mm

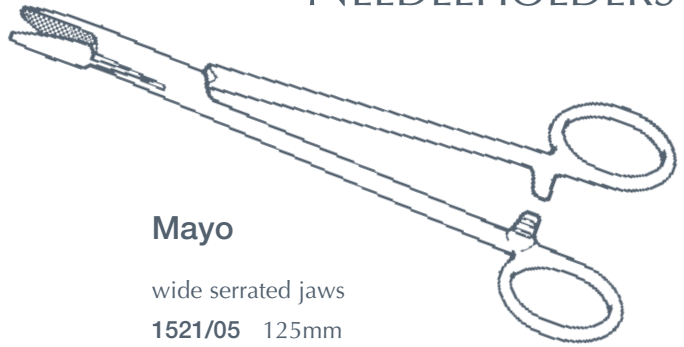

#### Mayo

wide serrated jaws  
1521/05 125mm  
1521/10 140mm  
1521/18 160mm  
1521/28 185mm  
1521/35 200mm  
1521/40 230mm  
1521/45 255mm  
1521/50 305mm

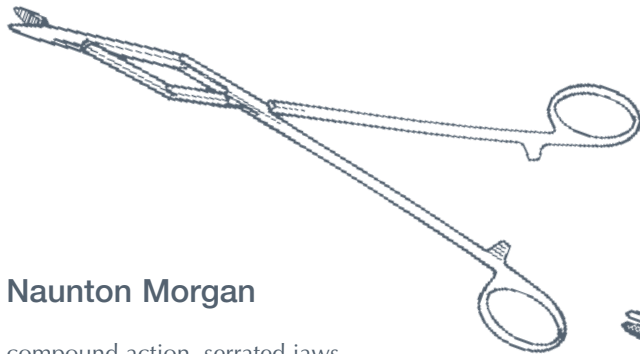
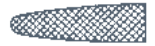

#### Naunton Morgan

compound action, serrated jaws  
1527/05 185mm  
1527/10 250mm

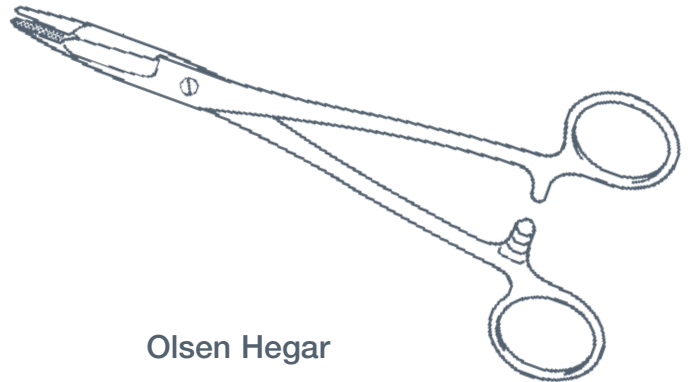

#### Olsen Hegar

serrated jaws  
1528/05 140mm  
1528/10 190mm

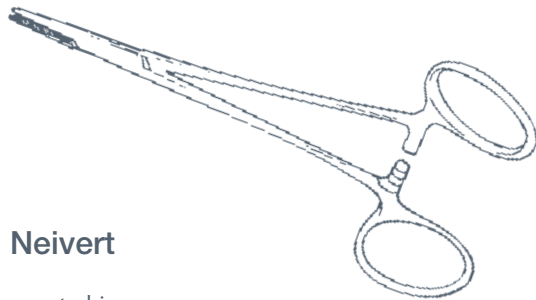

#### Neivert

serrated jaws  
1525/05 125mm

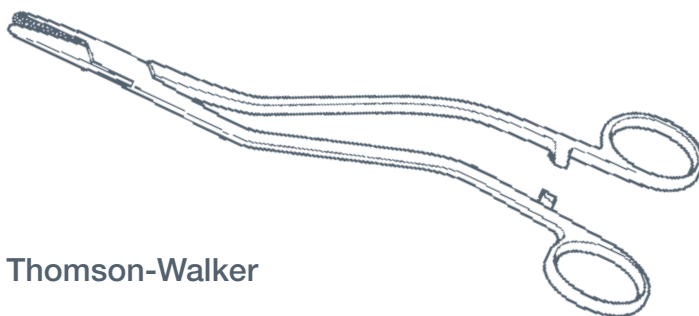

#### Thomson-Walker

serrated jaws  
1530/05 200mm

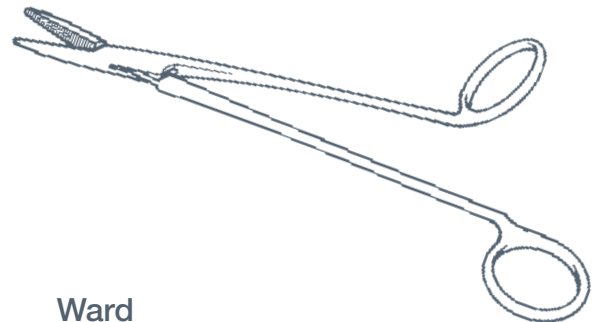

#### Ward

serrated, fenestrated jaws  
1535/05 180mm





### NEEDLEHOLDERS, TUNGSTEN CARBIDE

The needleholders shown on pages 26-28 have jaws made from tungsten carbide, which is the hardest and longest lasting material used in surgical instruments. The configuration of the jaws gives the best possible grip, and the gold bows allow clear and positive identification in the operating theatre.

In the event of accidental damage, repairs can be made quickly and economically.

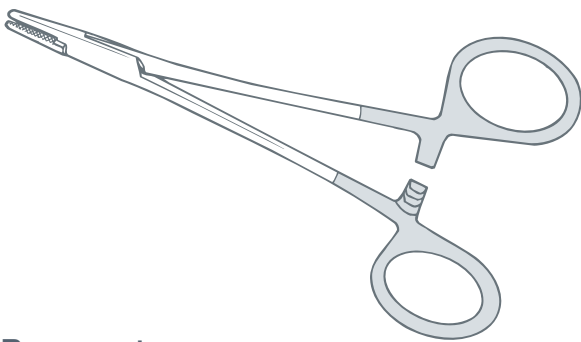

#### Baumgartner

1545/05 125mm

1545/10 140mm

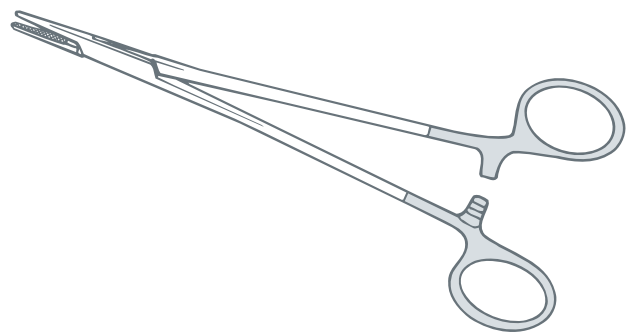
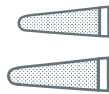

#### Crile Wood

1551/05 150mm

1551/10 180mm

1551/15 200mm

1551/20 230mm

1551/25 255mm

1551/30 305mm

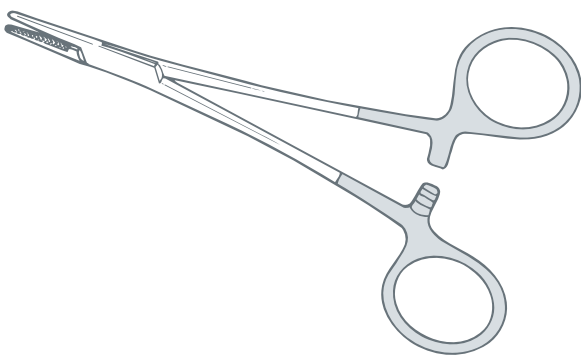
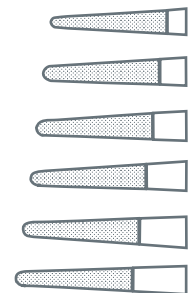

#### DeBakey

1554/05 180mm

1554/10 200mm

1554/15 230mm

1554/20 250mm

1554/25 305mm

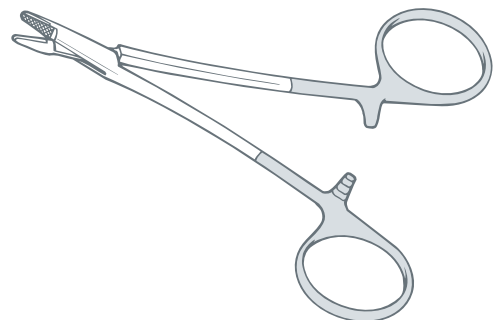
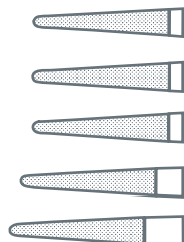

#### Derf

1556/05 120mm







### NEEDLEHOLDERS, TUNGSTEN CARBIDE

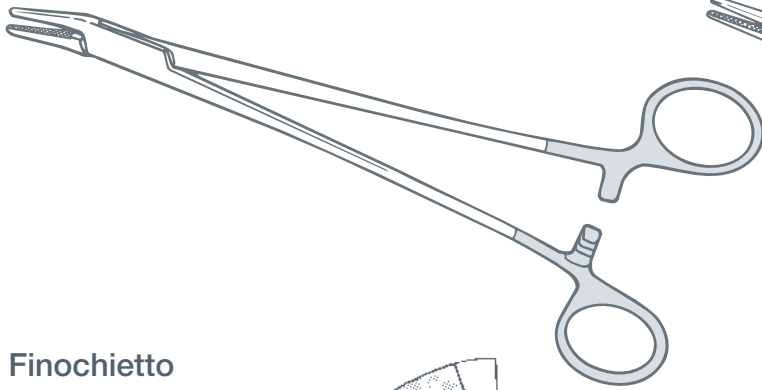

**Finochietto**

1557/05 200mm

1557/10 265mm

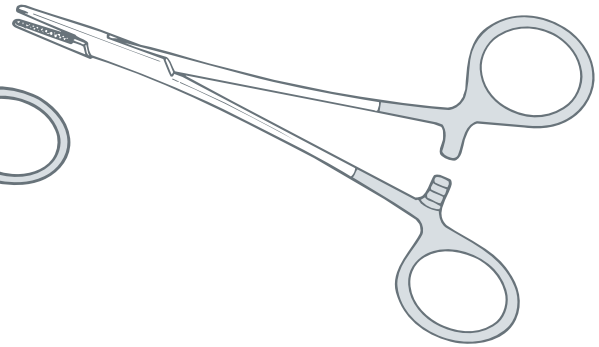
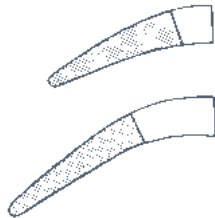

**Halsey**

1559/05 125mm

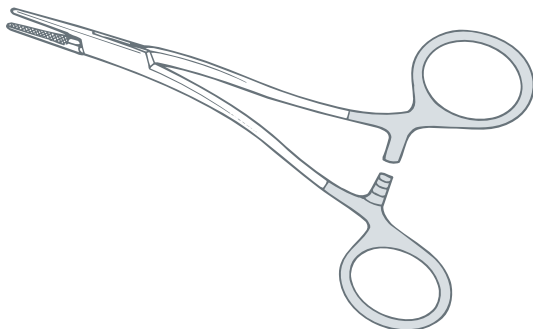

**Kilner**

1561/05 135mm

1561/10 165mm

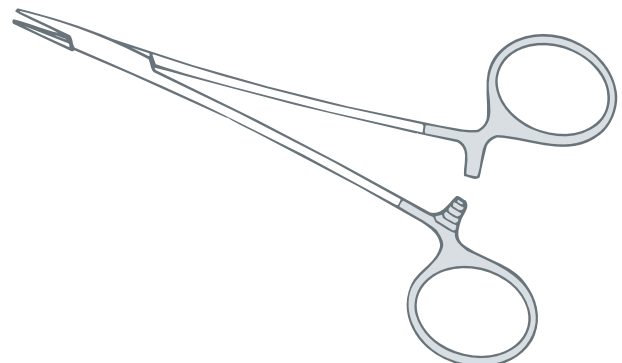

**Lawrance**

1567/05 150mm

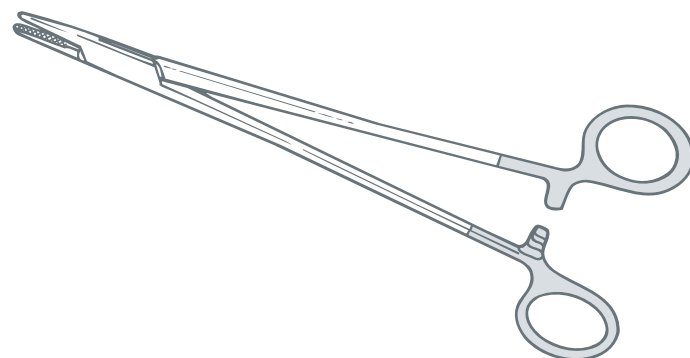

**Mayo**

1576/05 125mm

1576/10 140mm

1576/18 160mm

1576/30 185mm

1576/40 200mm

1576/45 230mm

1576/50 255mm

1576/55 305mm

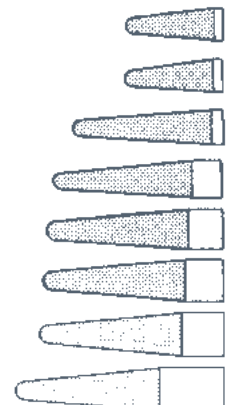



### NEEDLEHOLDERS, TUNGSTEN CARBIDE

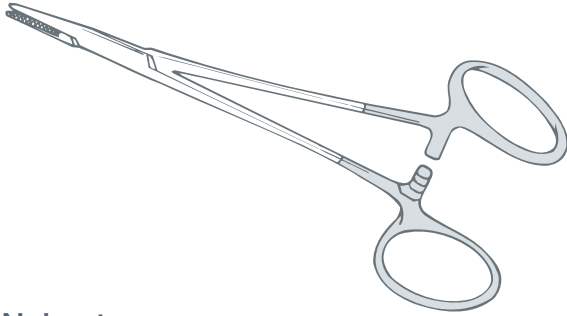

#### Neivert

1577/05 125mm

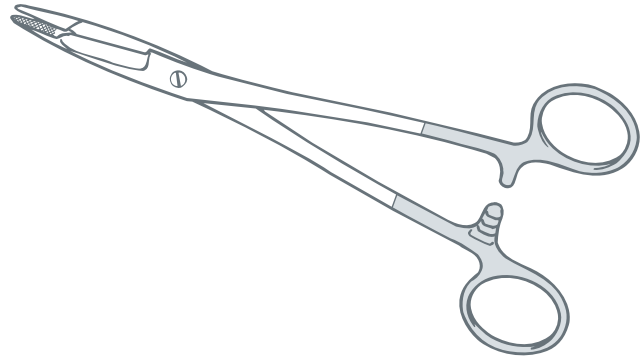

#### Olsen Hegar

1578/05 140mm



1578/10 190mm



#### Ryder

French eye

1579/05 125mm



1579/10 150mm



1579/15 180mm



1579/20 200mm



1579/25 230mm



1579/30 255mm

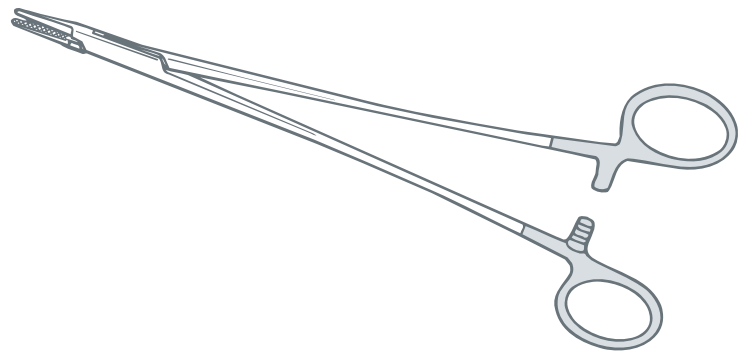

#### Thomson-Walker

1585/05 200mm

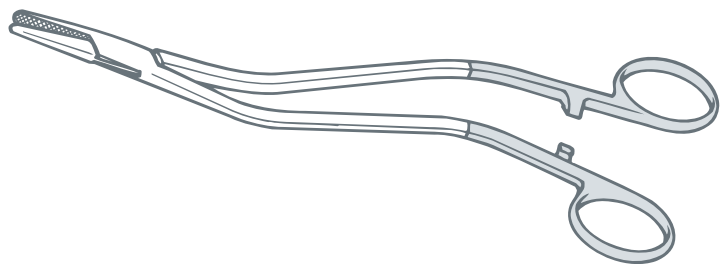

#### Webster

smooth jaws

1588/05 130mm

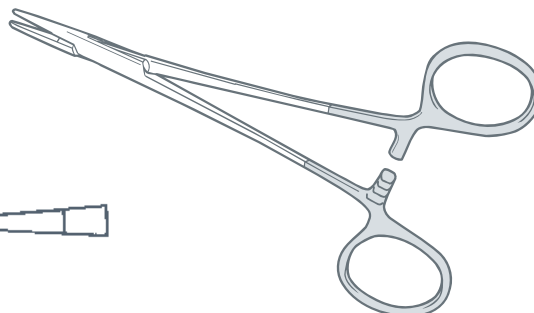



## NEEDLES

GEN



### Aneurysm

small curve  
1591/05 145mm



### Cooper

1593/05 190mm



### Deschamps

curved to left  
1595/25 270mm



curved to right  
1595/50 270mm



### Dupuytren

curved to left  
1597/25 170mm



curved to right  
1597/50 170mm



### Jolls

200mm  
1599/25 fig 1  
1599/50 fig 2  
1599/75 fig 3

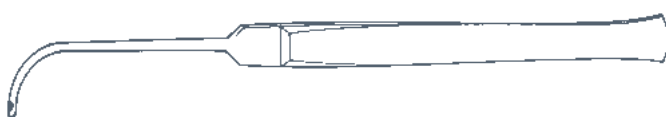
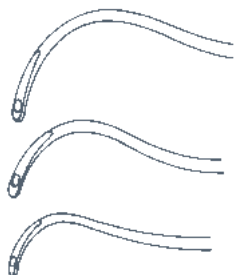

### Symes

1601/05 165mm



## PLASTER INSTRUMENTS



**Bohler Bender**

1612/05 255mm

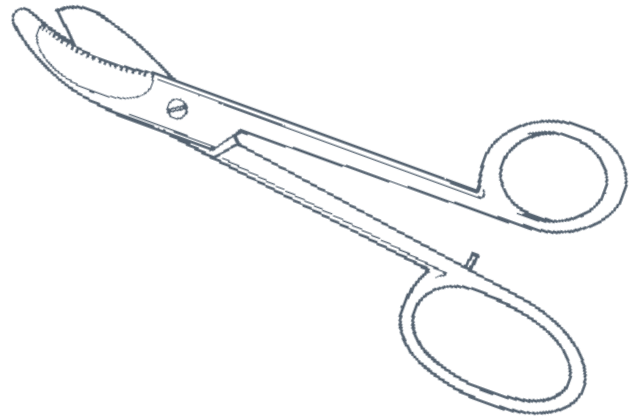

**Bruns/Bohler Shears**

1614/05 240mm

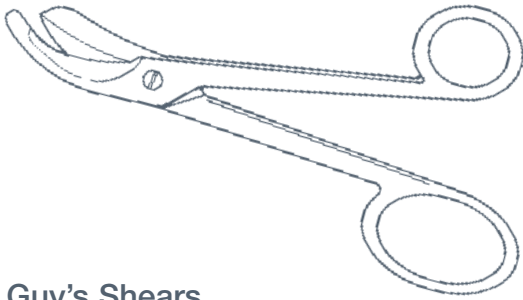

**Guy's Shears**

probe end  
1615/05 250mm

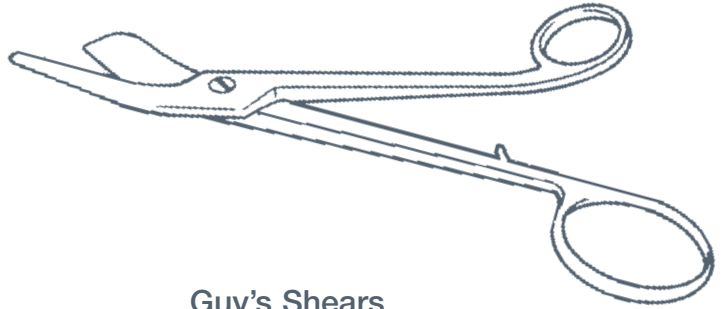

**Guy's Shears**

flattened end  
1616/05 290mm

**Hennig Spreader**

1619/05 280mm

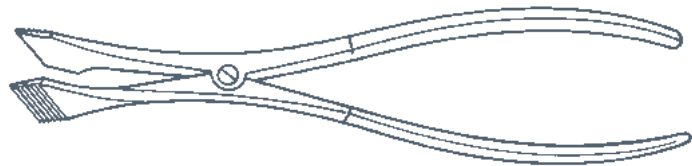

**Stille-Lorenz Shears**

1625/05 230mm  
1625/10 260mm  
1625/15 370mm

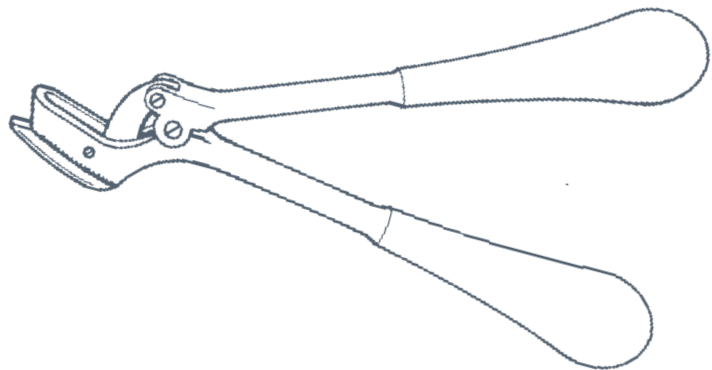



## POST MORTEM INSTRUMENTS

GEN

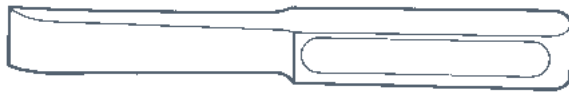

### Chisel

1635/05 19mm x 175mm

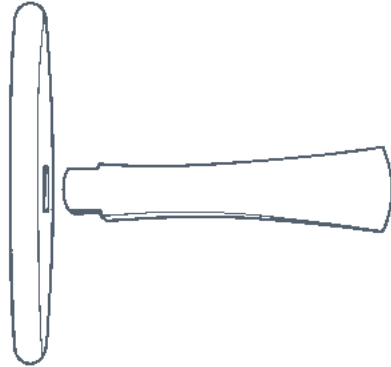

### Cross Handle Chisel

1636/05 25mm blade

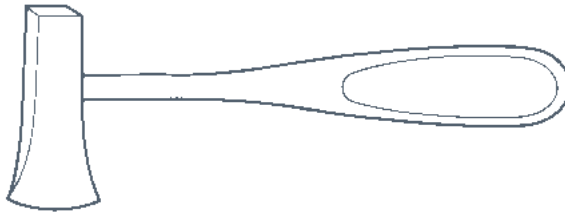

### Hammer

wrench end

1638/05 32mm blade

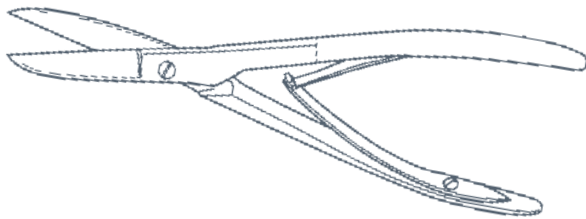

### Shears

skull

1640/05 230mm

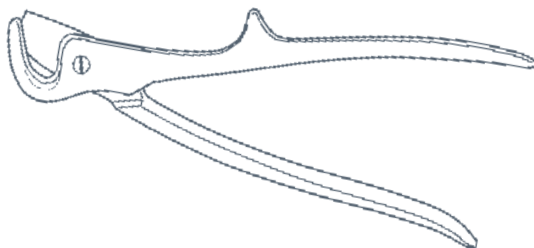

### Shears

rib

1641/05 210mm

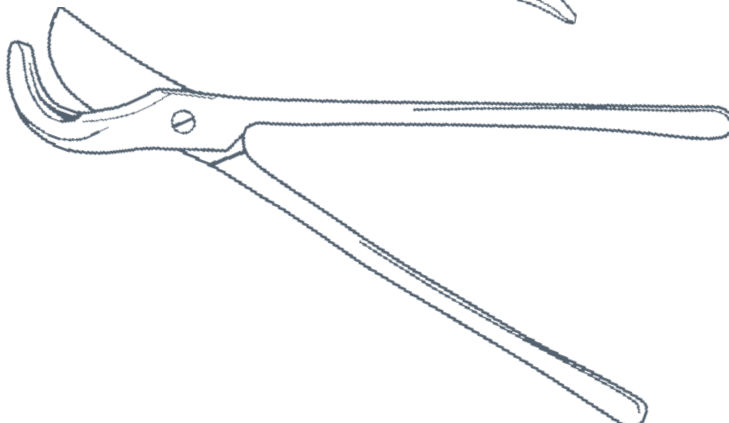

### Shears

pollocks rib

1642/05 320mm



## POST MORTEM INSTRUMENTS



### Knife

solid forged single edge

**1644/05** 210mm, 85mm blade

**1644/10** 220mm, 95mm blade

**1644/15** 235mm, 108mm blade

**1644/20** 245mm, 120mm blade

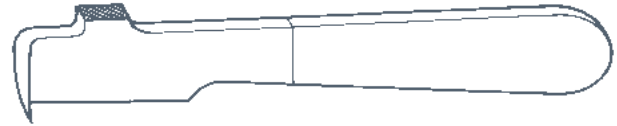

### Spine Wrench

**1647/05** 215mm

## PROBES

### Brodie

grooved, probe end

**1650/10** 130mm

**1650/15** 145mm

**1650/20** 160mm

**1650/25** 180mm



### Nickel Silver

with eye, made in Pakistan

**1653/05** 125mm

**1653/10** 150mm

**1653/15** 180mm

**1653/20** 200mm

**1653/25** 250mm

**1653/30** 300mm



### Sinus

silver

**1656/05** 150mm





## RETRACTORS

GEN

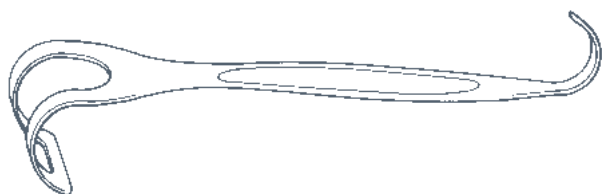

### Canny Ryall

fenestrated blade

**1659/05** 190mm, 16mm x 25mm blade

**1659/10** 190mm, 19mm x 28mm blade

**1659/15** 200mm, 25mm x 32mm blade



### Czerny

double ended

**1662/05** 180mm

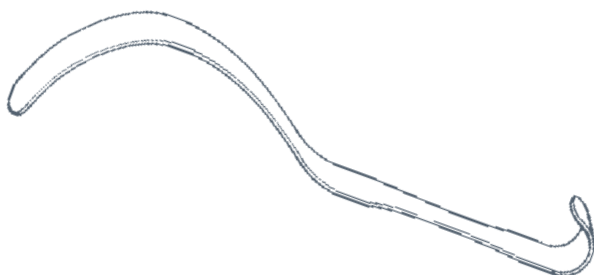

### Deaver Abdominal

flat handles

**1665/05** No. 1, 305mm, 25mm blade

**1665/10** No. 2, 330mm, 25mm blade

**1665/15** No. 3, 305mm, 38mm blade

**1665/20** No. 4, 305mm, 50mm blade

**1665/25** No. 5, 305mm, 75mm blade

**1665/95** set of 5

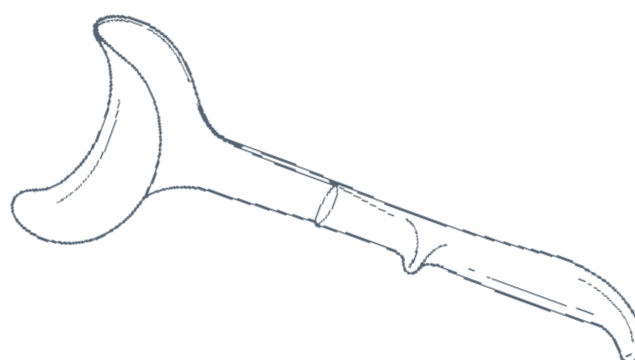

### Doyen

250mm overall length

**1669/05** 50mm x 85mm blade

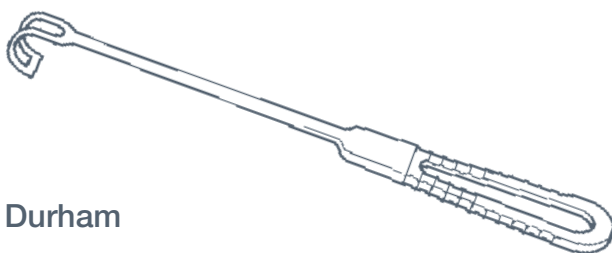

### Durham

**1672/05** 10mm blade

**1672/10** 16mm blade

**1672/15** 22mm blade

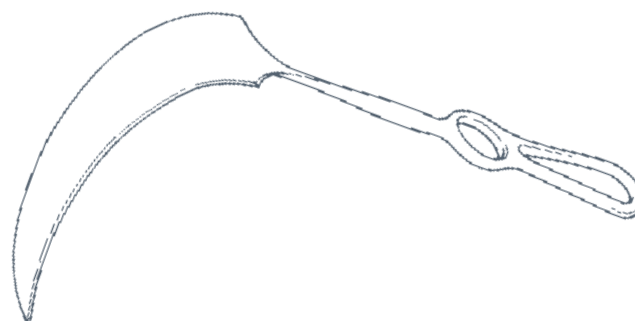

### Kelly

270mm overall length

**1686/05** 185mm x 38mm blade

**1686/10** 185mm x 57mm blade



### RETRACTORS

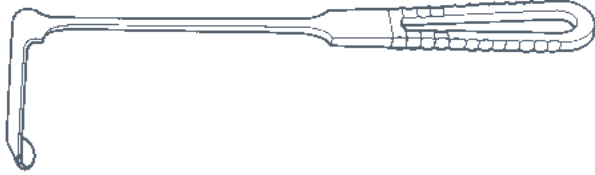

#### Langenbeck

single ended

**1692/05** 22mm x 6mm blade

**1692/10** 45mm x 13mm blade

**1692/15** 65mm x 25mm blade

**1692/20** 90mm x 20mm blade

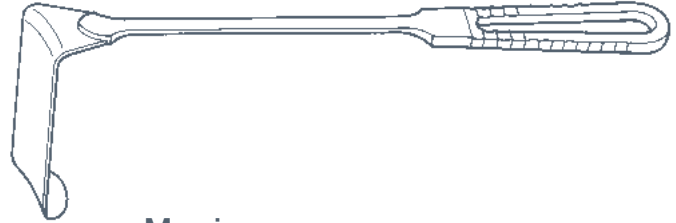

#### Morris

single ended

**1696/05** 245mm, 70mm x 40mm blade

**1696/10** 245mm, 70mm x 50mm blade

**1696/15** 245mm, 70mm x 65mm blade



#### Morris

double ended

**1697/05** 215mm, 30mm x 50mm and  
40mm x 50mm blades

**1697/10** 215mm, 45mm x 50mm and  
50mm x 50mm blades

**1697/15** 215mm, 60mm x 50mm and  
65mm x 50mm blades



#### Moynihan

single ended

**1699/05** 215mm, 13mm x 22mm blade

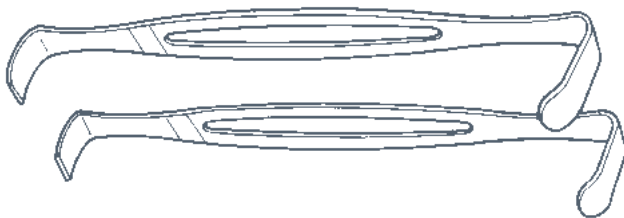

#### Parker-Langenbeck (US Army)

set of 2

**1707/05** 210mm

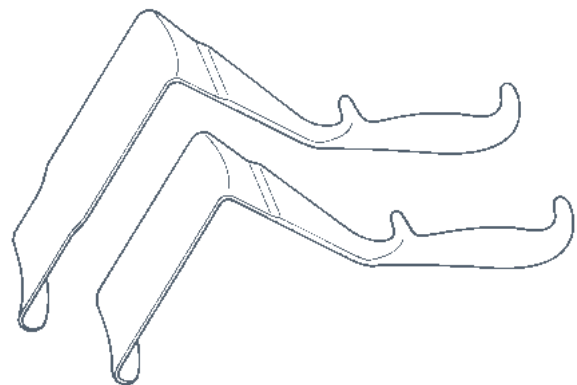

#### St Marks Hospital

with lip

**1713/05** 125mm x 60mm blade

**1713/10** 175mm x 60mm blade





## RETRACTORS

GEN



### Tracheal Hook

single

1716/25 blunt, 150mm

1716/50 sharp, 150mm



### Tracheal Hook

double

1717/25 blunt, 180mm

1717/50 sharp, 180mm



### Volkmann

blunt, 220mm

1719/05 1 prong

1719/10 2 prong

1719/15 3 prong

1719/20 4 prong

1719/25 6 prong



sharp, 220mm

1721/05 1 prong

1721/10 2 prong

1721/15 3 prong

1721/20 4 prong

1721/25 6 prong



### Walton

copper, malleable

1724/05 305mm x 13mm

1724/10 305mm x 19mm

1724/15 305mm x 25mm

1724/20 305mm x 32mm

1724/25 305mm x 38mm

1724/30 305mm x 50mm



### RETRACTORS, AMPUTATION

#### Blake Flap

1727/05 240mm diameter

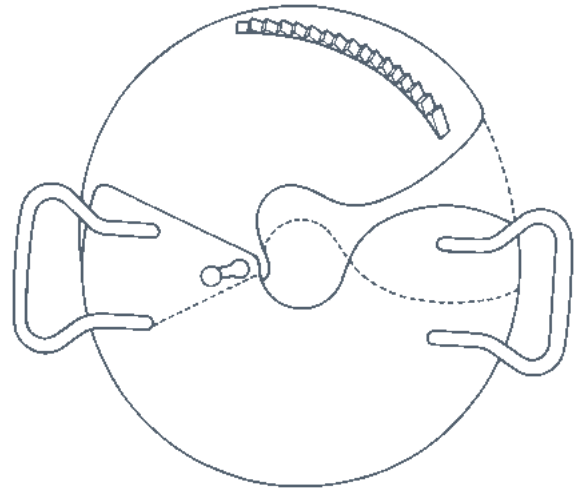

### RETRACTORS, SELF-RETAINING

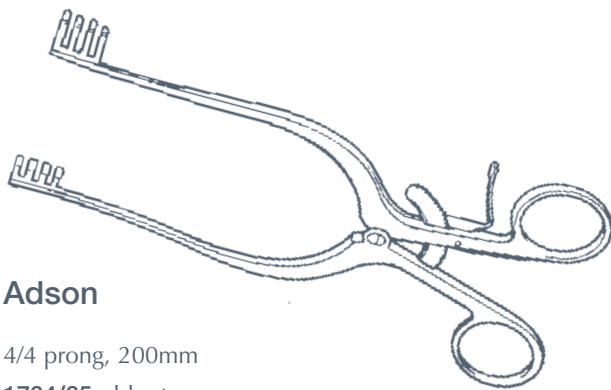

#### Adson

4/4 prong, 200mm

1734/25 blunt

1734/50 sharp

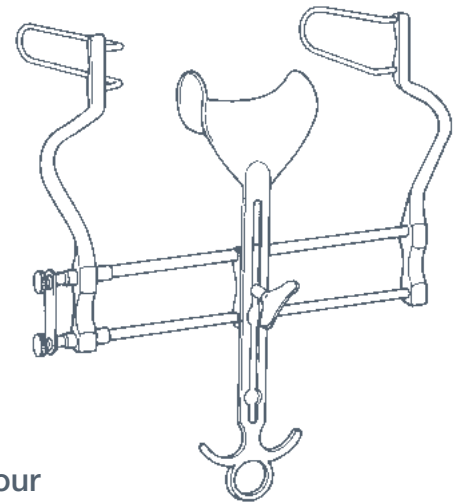

#### Balfour

fenestrated end blades 180mm,

63mm x 35mm blades

1737/05

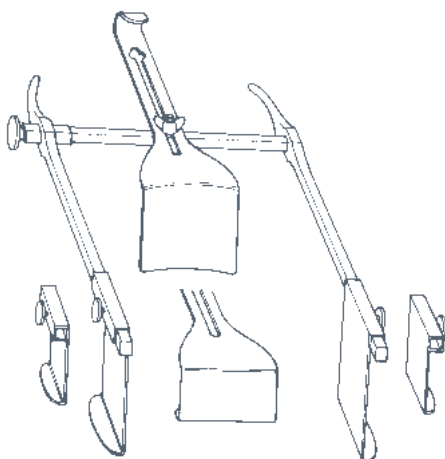

#### Goligher

complete 165mm, 2 centre blades,

2 lateral blades 51mm deep and

2 lateral blades 100mm deep

1753/05

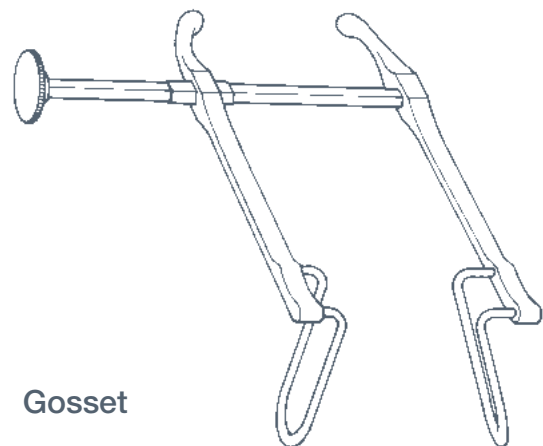

#### Gosset

2 blades

1755/05 large

1755/10 small



### RETRACTORS, SELF-RETAINING

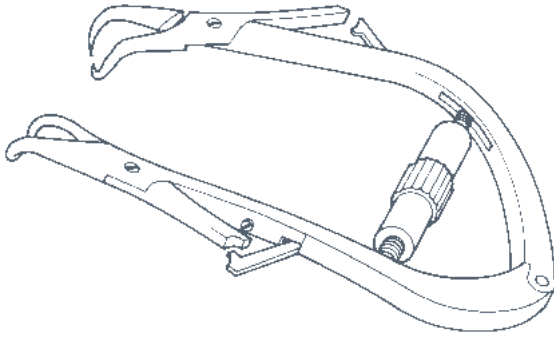

**Jolls Thyroid**

1758/05 150mm

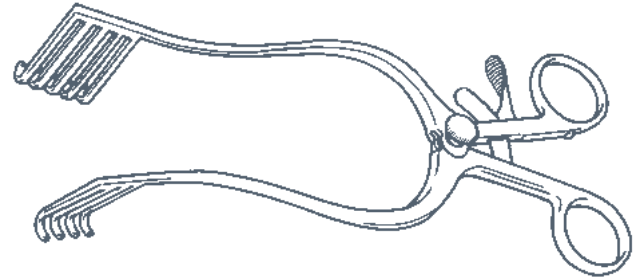

**Norfolk and Norwich**

cam rack, 4/5 teeth

1770/05 215mm, 50mm blades

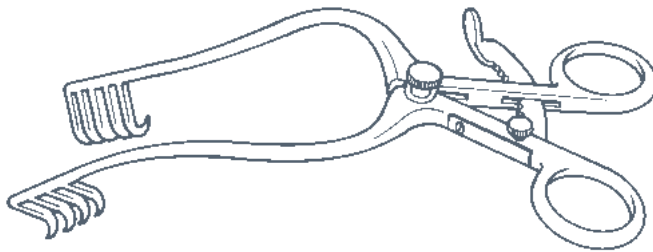

**Travers**

4/5 teeth

1778/05 200mm, 19mm x 25mm and  
25mm x 25mm blades

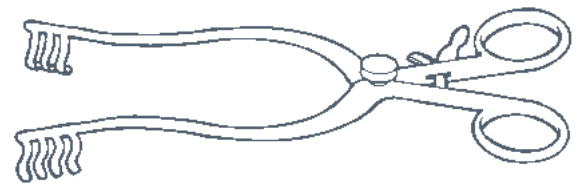

**Weislander**

3/4 teeth

1780/05 140mm

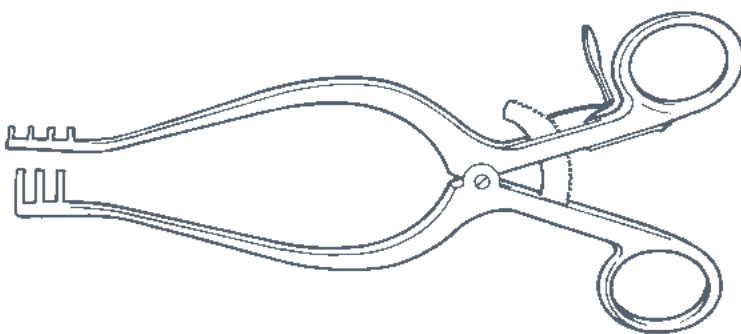

**Weitlaner**

blunt

1782/05 200mm

1782/10 240mm

sharp

1783/05 200mm

1783/10 240mm

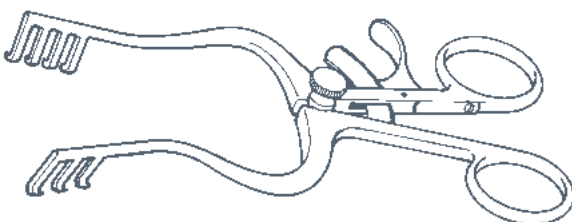

**West**

sharp

1785/05 140mm



GEN

## RING CUTTER

complete, made in Pakistan

1788/25 165mm

spare blade

1788/50 carbon steel

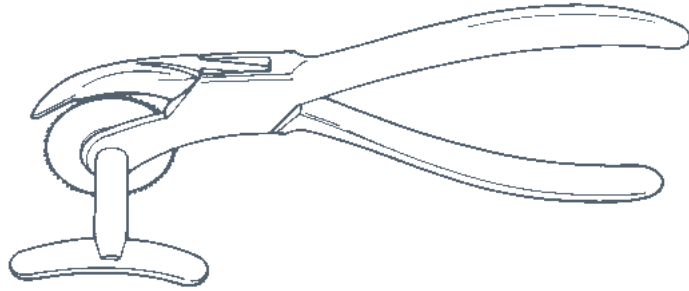

## SAWS

### Amputation

1791/05 200mm

1791/10 225mm

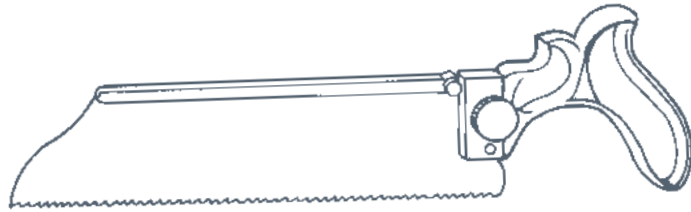

### Engels

1795/05 plaster saw

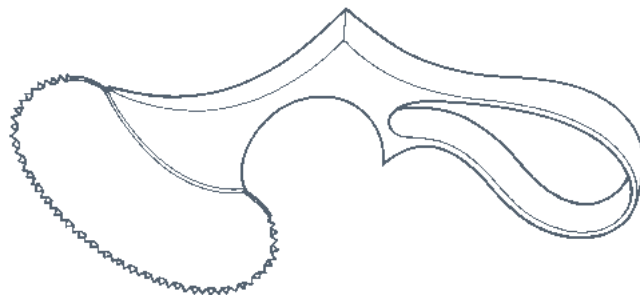



## SCALPELS

GEN

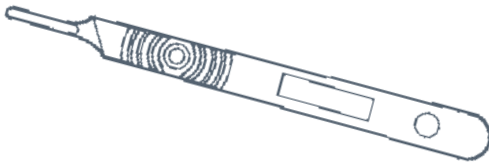

### Swann Morton

handle  
1802/05 No. 3

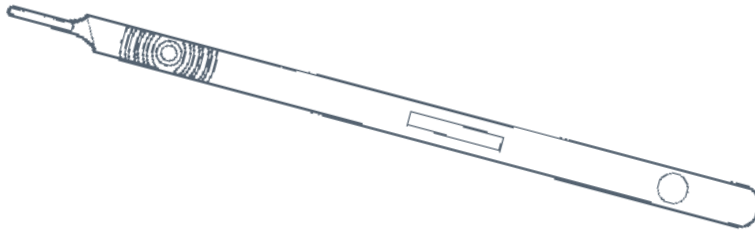

### Swann Morton

handle  
1802/10 No. 3L

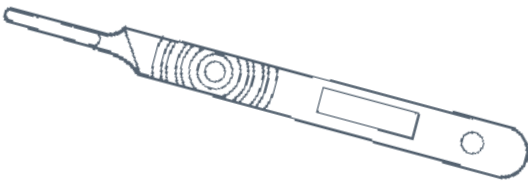

### Swann Morton

handle  
1802/15 No. 4

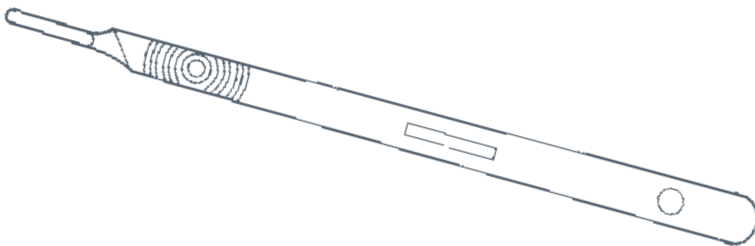

### Swann Morton

handle  
1802/20 No. 4L

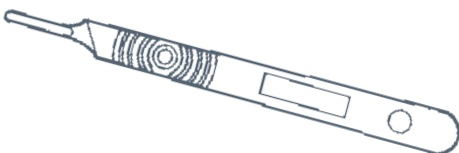

### Swann Morton

handle  
1802/25 No. 5 (7)



### SCALPELS

#### Swann Morton

1803/05-25 blades, **carbon, non-sterile** to fit handles Nos. 3, 3L and 5

1804/05-25 blades, **carbon, sterile** to fit handles Nos. 3, 3L and 5

1803/05 No. 10

1804/05



1803/10 No. 10A

1804/10



1803/15 No. 11

1804/15



1803/20 No. 12

1804/20



1803/25 No. 15

1804/25



#### Swann Morton

1803/30-70 blades, **carbon, non-sterile** to fit handles Nos. 4 and 4L

1804/30-70 blades, **carbon, sterile** to fit handles Nos. 4 and 4L

1803/30 No. 20

1804/30



1803/35 No. 21

1804/35



1803/40 No. 22

1804/40



1803/45 No. 22A

1804/45



1803/50 No. 23

1804/50



1803/55 No. 24

1804/55



1803/60 No. 25

1804/60



1803/65 No. 26

1804/65



1803/70 No. 27

1804/70





## SCISSORS

GEN

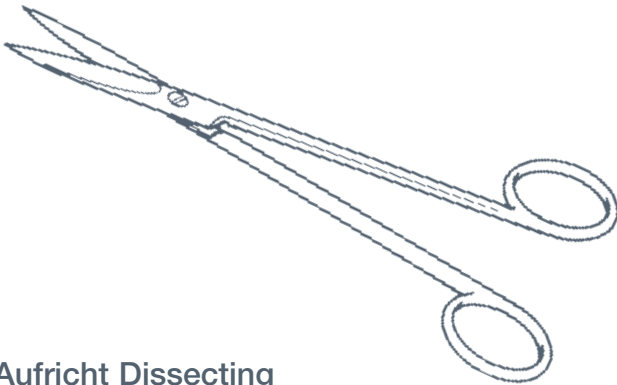

### Aufricht Dissecting

straight, light pattern  
1820/05 150mm

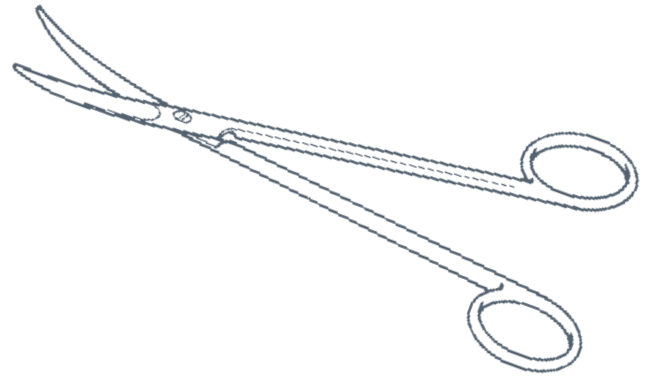

### Aufricht Dissecting

curved, light pattern  
1821/05 150mm

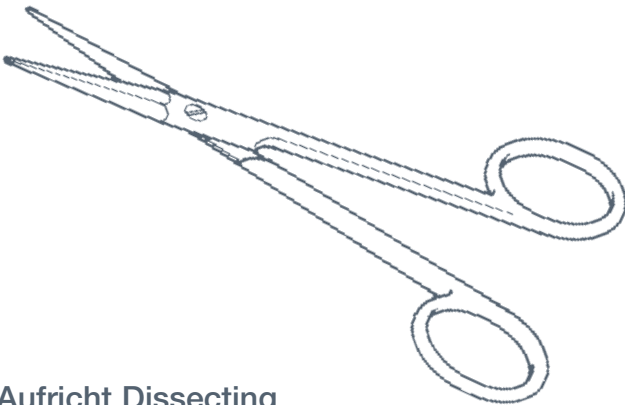

### Aufricht Dissecting

straight, triangular blade  
1822/05 140mm

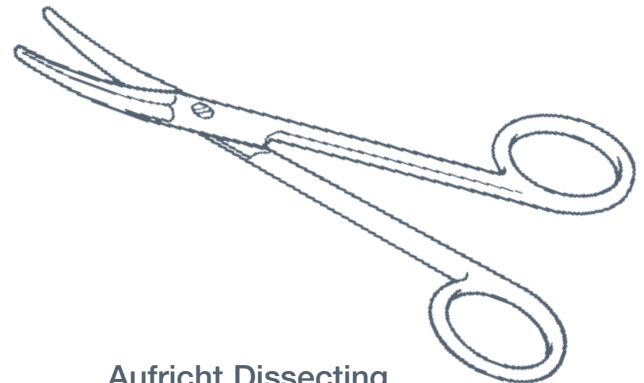

### Aufricht Dissecting

curved, triangular blade  
1823/05 140mm

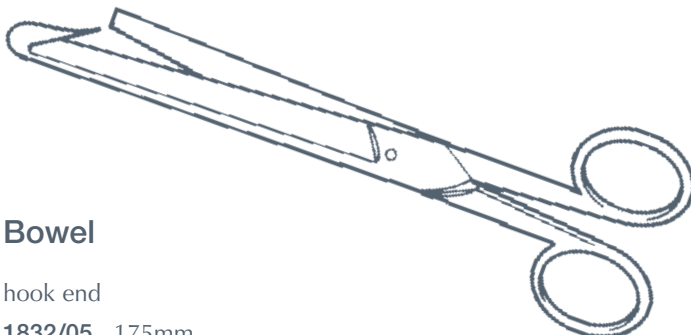

### Bowel

hook end  
1832/05 175mm

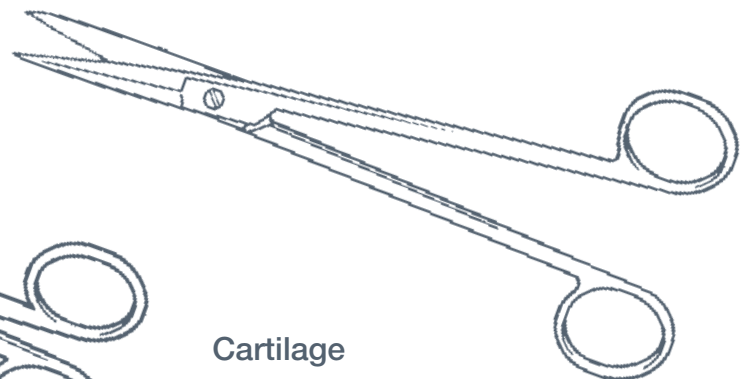

### Cartilage

straight, fine points, serrated blades  
1837/05 180mm



### SCISSORS

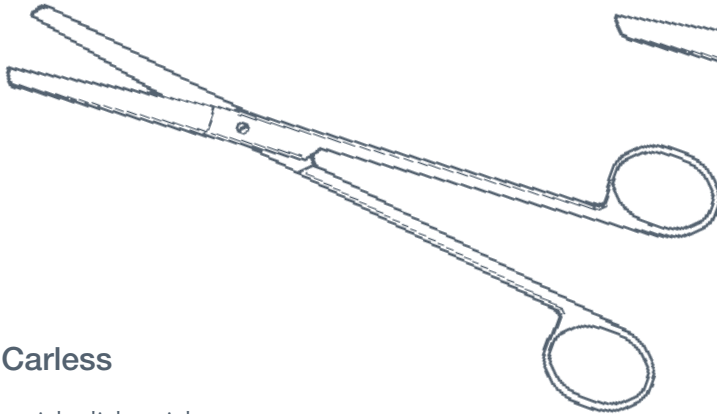

#### Carless

straight, lightweight,  
blunt point

1838/05 165mm

1838/10 200mm

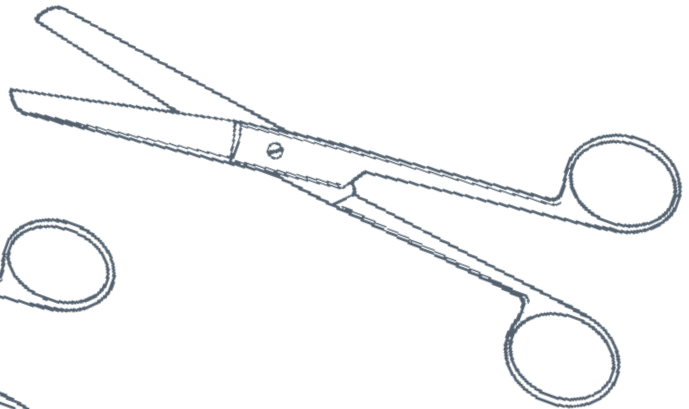

#### Doyen

straight, blunt point

1840/05 180mm

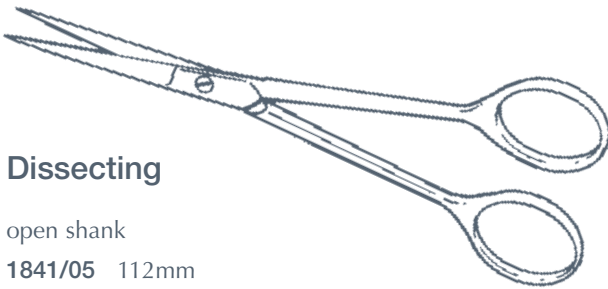

#### Dissecting

open shank

1841/05 112mm

1841/10 125mm

1841/15 150mm



#### Dressing

straight, blunt/blunt

1842/05 100mm

1842/10 125mm

1842/15 140mm

1842/20 150mm

1842/25 180mm

1842/30 200mm

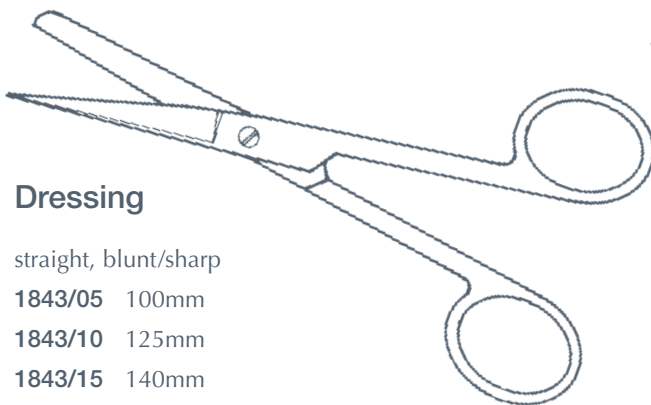

#### Dressing

straight, blunt/sharp

1843/05 100mm

1843/10 125mm

1843/15 140mm

1843/20 150mm

1843/25 180mm

1843/30 200mm



#### Dressing

straight, sharp/sharp

1844/05 100mm

1844/10 125mm

1844/15 140mm

1844/20 150mm

1844/25 180mm

1844/30 200mm





## SCISSORS

GEN

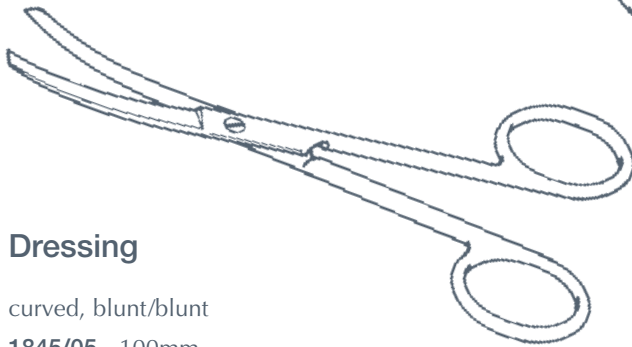

### Dressing

curved, blunt/blunt

- 1845/05 100mm
- 1845/10 125mm
- 1845/15 140mm
- 1845/20 150mm
- 1845/25 180mm
- 1845/30 200mm

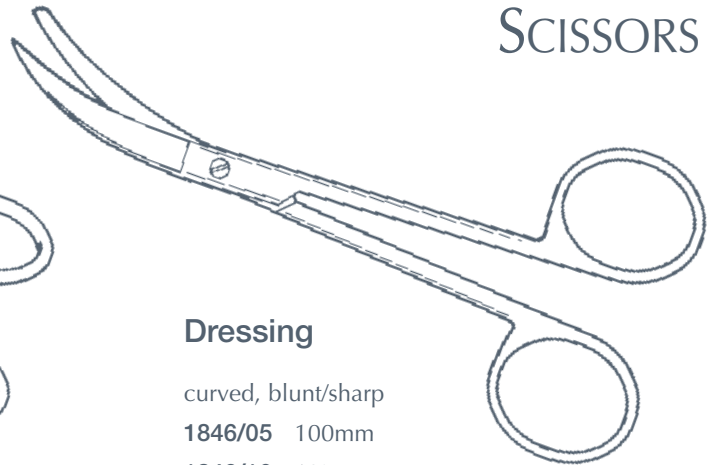

### Dressing

curved, blunt/sharp

- 1846/05 100mm
- 1846/10 125mm
- 1846/15 140mm
- 1846/20 150mm
- 1846/25 180mm
- 1846/30 200mm

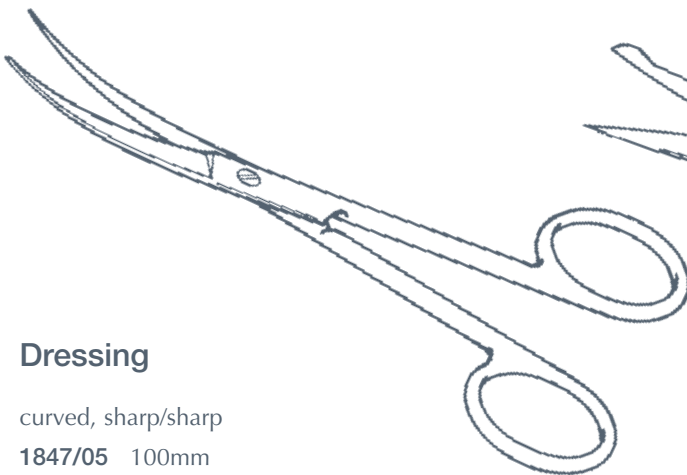

### Dressing

curved, sharp/sharp

- 1847/05 100mm
- 1847/10 125mm
- 1847/15 140mm
- 1847/20 150mm
- 1847/25 180mm
- 1847/30 200mm

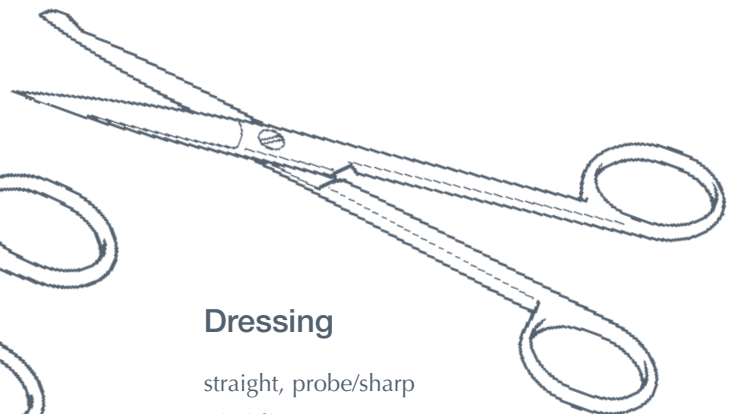

### Dressing

straight, probe/sharp

- 1848/05 125mm
- 1848/10 145mm

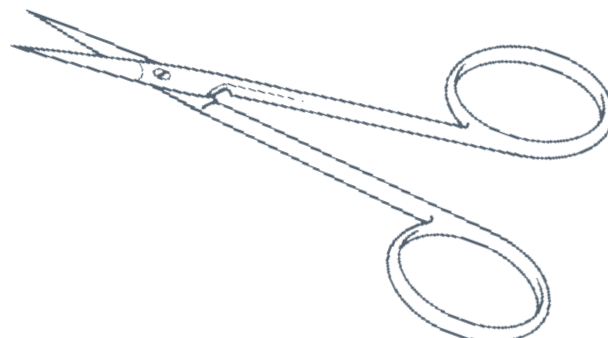

### Elliot Iris

sharp points

- 1850/05 85mm



## SCISSORS

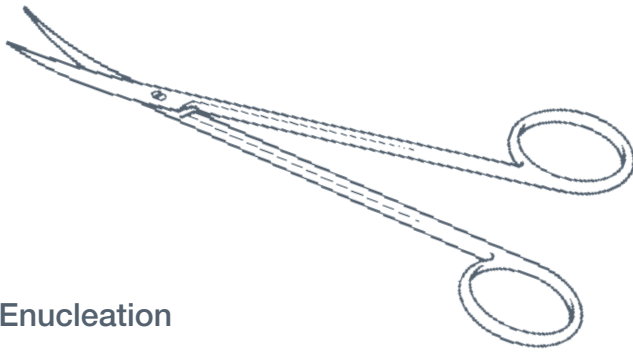

### Enucleation

curved on flat

1852/05 90mm

1852/10 115mm

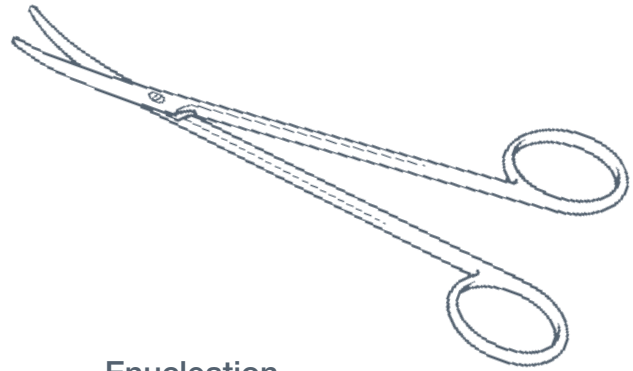

### Enucleation

curved on flat, extra strong

1853/05 115mm

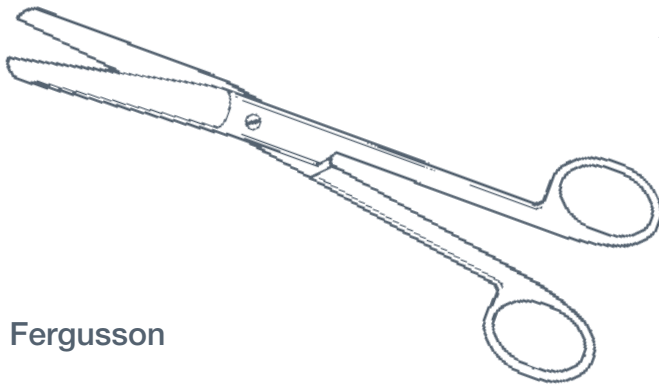

### Fergusson

angled on flat

1858/05 145mm

1858/10 150mm

1858/15 180mm



### Glasgow Iris

straight, fine sharp points

1859/05 100mm

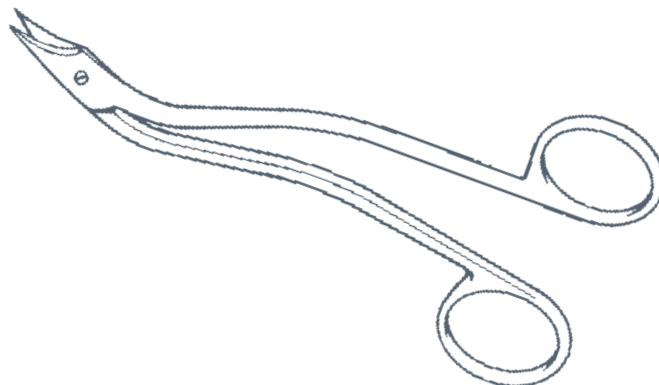

### Heaths Stitch

1864/05 150mm



## SCISSORS

GEN

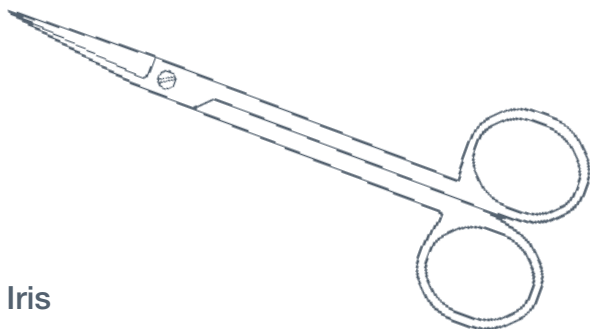

### Iris

straight, sharp

**1866/05** 90mm

**1866/10** 110mm

straight, lightweight, sharp

**1866/25** 90mm

**1866/30** 110mm

straight, super lightweight, sharp

**1866/50** 110mm

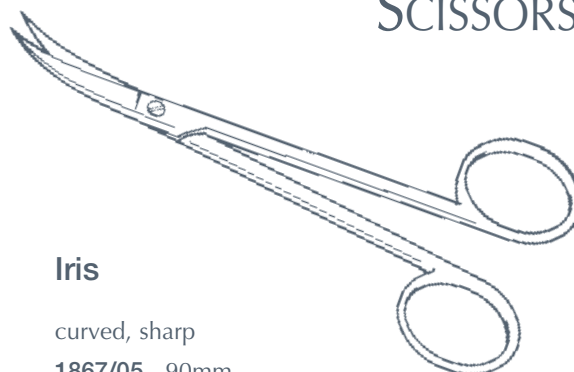

### Iris

curved, sharp

**1867/05** 90mm

**1867/10** 110mm

curved, lightweight, sharp

**1867/25** 90mm

**1867/30** 110mm

curved, super lightweight, sharp

**1867/50** 110mm

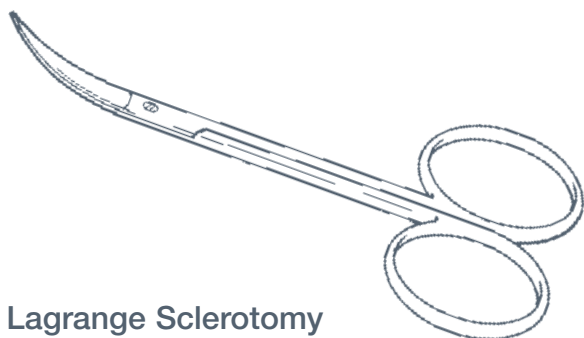

### Lagrange Sclerotomy

curved

**1868/05** 90mm

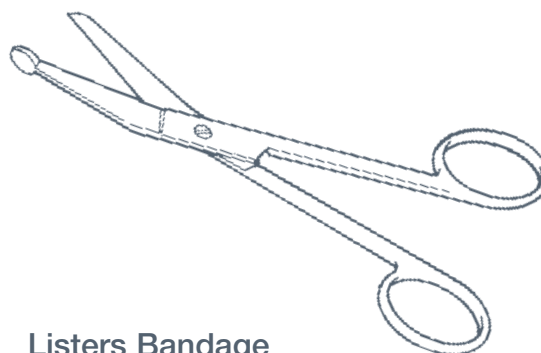

### Listers Bandage

**1869/05** 140mm

**1869/10** 180mm

**1869/15** 200mm

**1869/20** 235mm

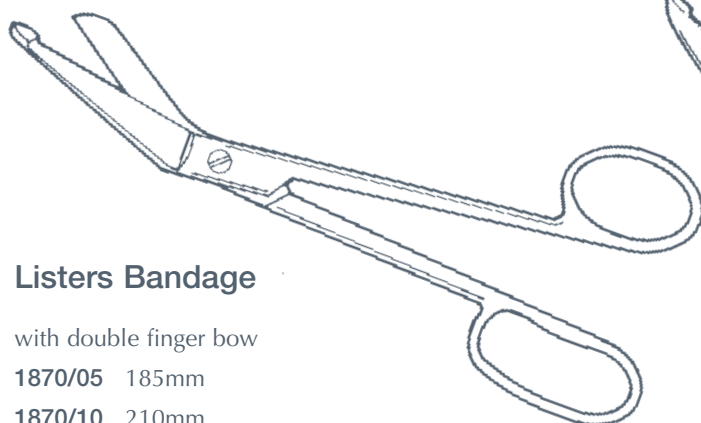

### Listers Bandage

with double finger bow

**1870/05** 185mm

**1870/10** 210mm



### Listers, Eccentric

**1871/05** 160mm

**1871/10** 190mm



### SCISSORS

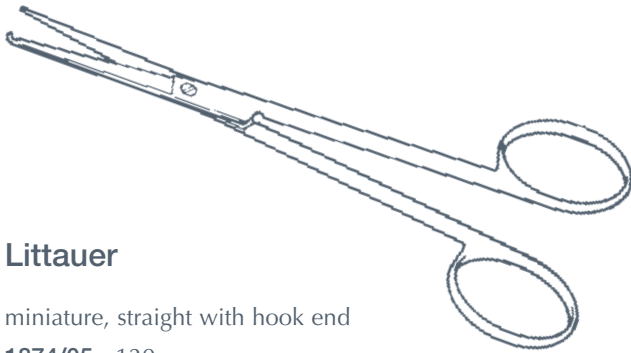

#### Littauer

miniature, straight with hook end  
1874/05 120mm

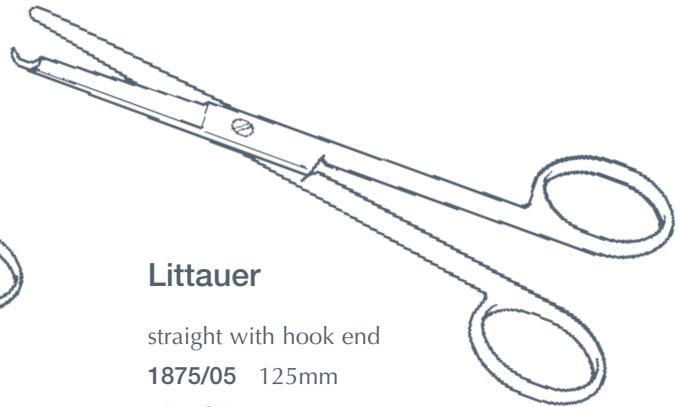

#### Littauer

straight with hook end  
1875/05 125mm  
1875/10 140mm  
1875/15 180mm

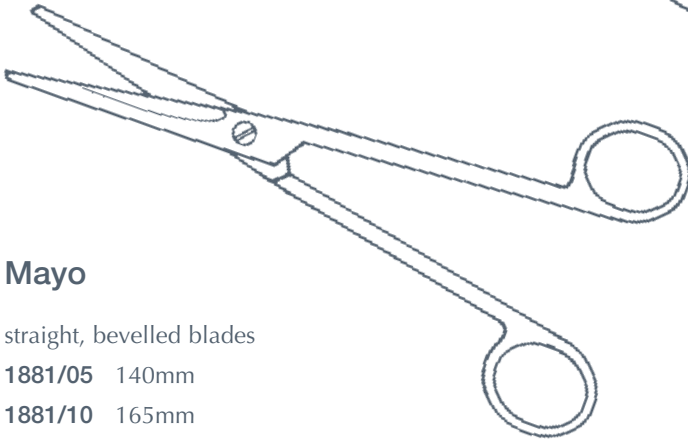

#### Mayo

straight, bevelled blades  
1881/05 140mm  
1881/10 165mm  
1881/15 190mm  
1881/20 215mm

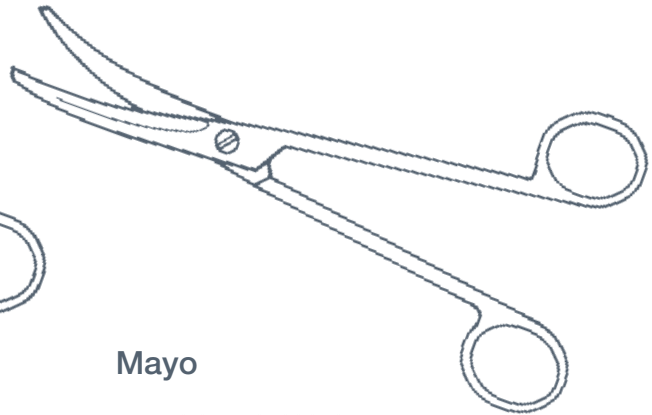

#### Mayo

curved, bevelled blades  
1882/05 140mm  
1882/10 165mm  
1882/15 190mm  
1882/20 215mm

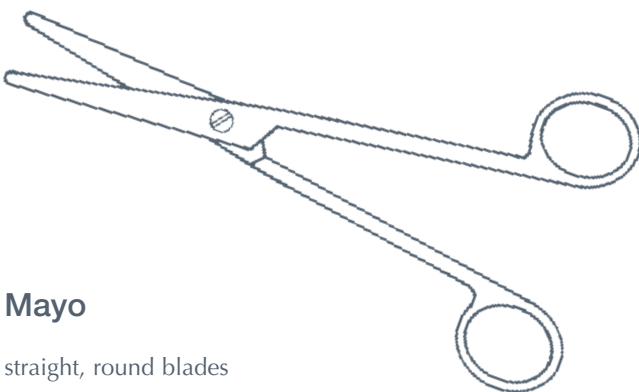

#### Mayo

straight, round blades  
1883/05 140mm  
1883/10 170mm

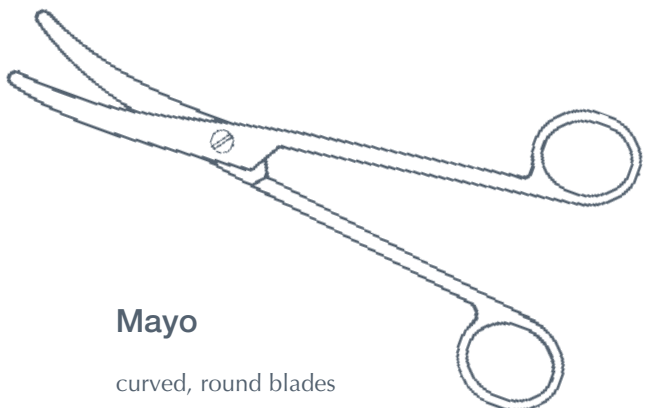

#### Mayo

curved, round blades  
1884/05 140mm  
1884/10 170mm



## SCISSORS

GEN

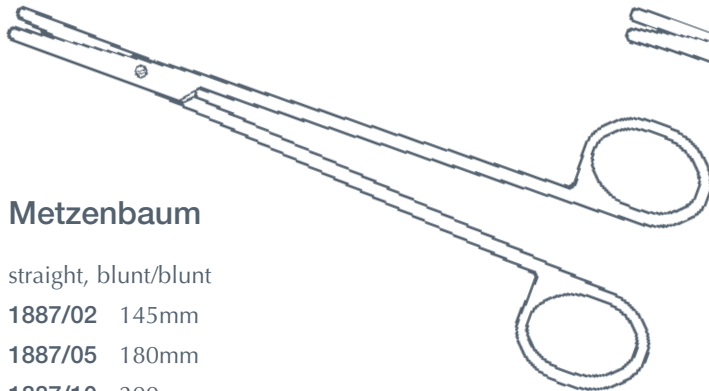

### Metzenbaum

straight, blunt/blunt

1887/02 145mm

1887/05 180mm

1887/10 200mm

1887/15 230mm

1887/20 250mm

1887/25 280mm

1887/30 300mm

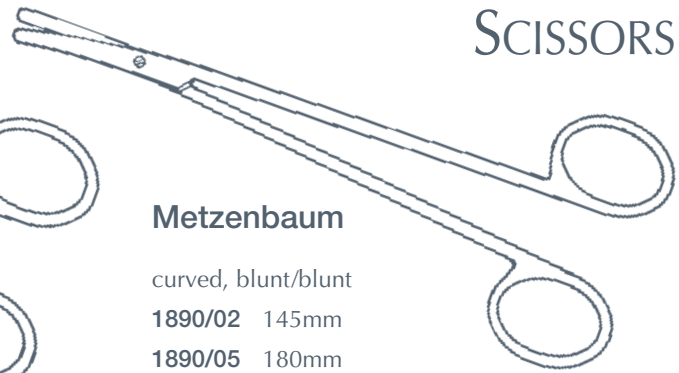

### Metzenbaum

curved, blunt/blunt

1890/02 145mm

1890/05 180mm

1890/10 200mm

1890/15 230mm

1890/20 250mm

1890/25 280mm

1890/30 300mm

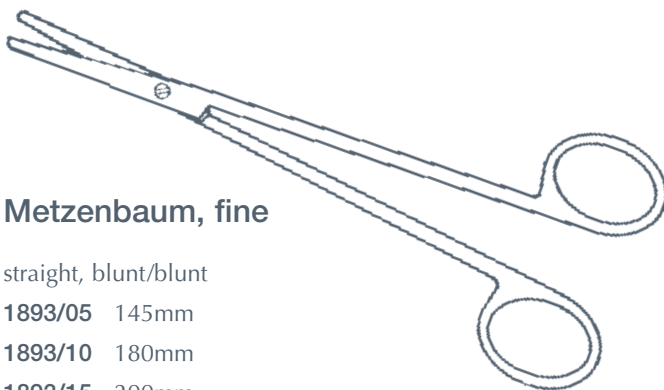

### Metzenbaum, fine

straight, blunt/blunt

1893/05 145mm

1893/10 180mm

1893/15 200mm

1893/20 230mm



### Metzenbaum, fine

straight, sharp/sharp

1894/05 145mm

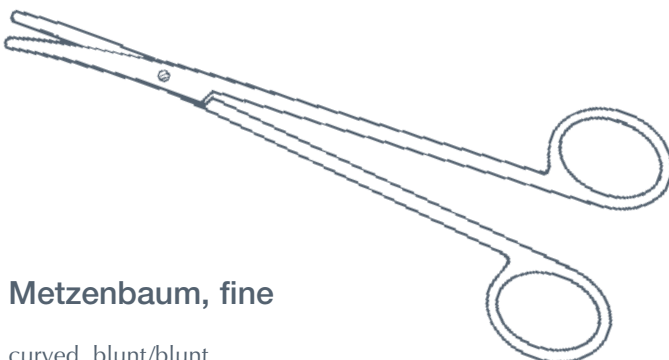

### Metzenbaum, fine

curved, blunt/blunt

1895/05 145mm

1895/10 180mm

1895/15 200mm

1895/20 230mm

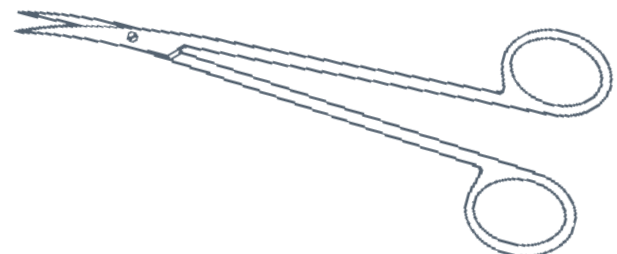

### Metzenbaum, fine

curved, sharp/sharp

1896/05 145mm



### SCISSORS

#### Nelson Lobectomy

straight  
1898/05 230mm

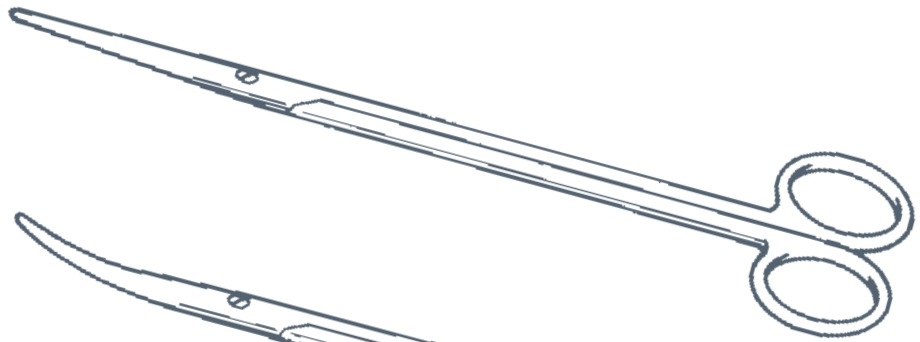

#### Nelson Lobectomy

curved  
1899/05 230mm

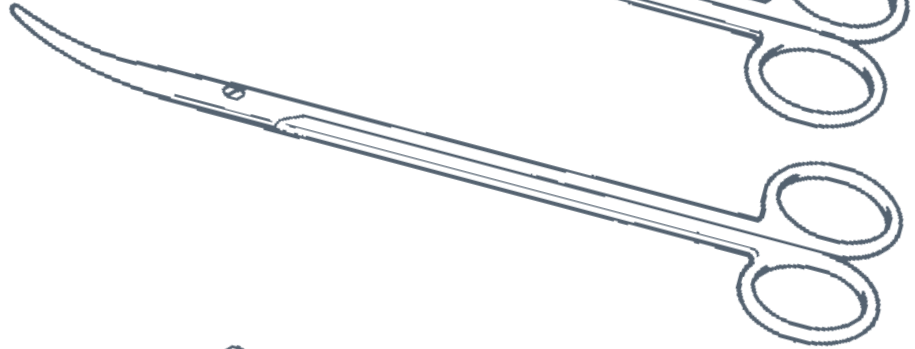

#### Paynes Suture

1900/01 100mm

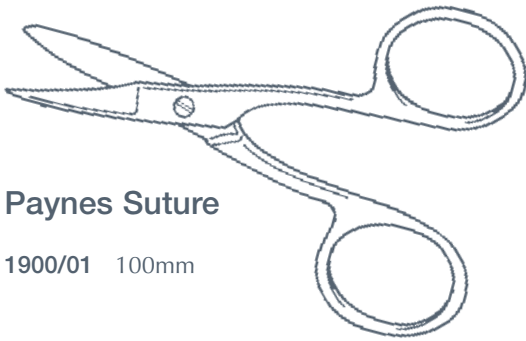

#### Post Mortem

ball end, open shank  
1900/05 140mm



#### Post Mortem

probe/sharp, open shank  
1904/05 100mm

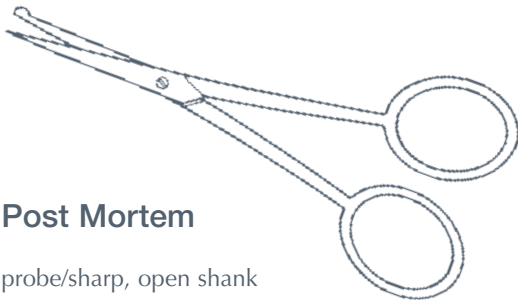

#### Stevens

straight, sharp  
1910/05 115mm

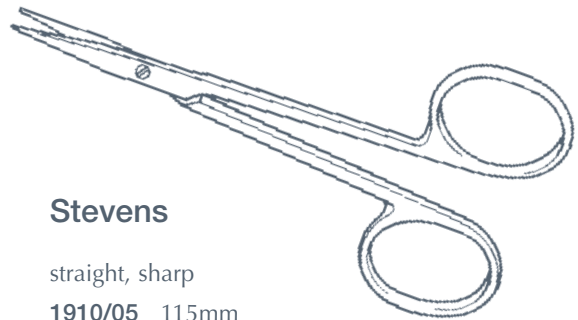

#### Stevens

curved, sharp  
1910/25 115mm

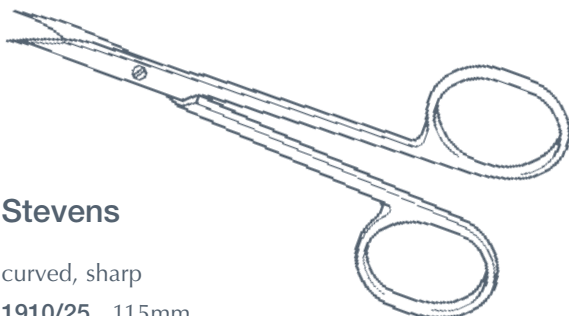

#### Stevens

straight, blunt  
1910/45 115mm





## SCISSORS

GEN

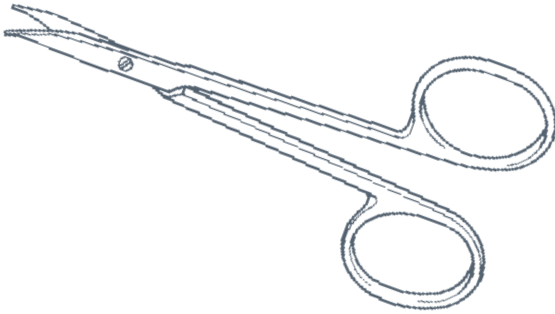

### Stevens

curved, blunt

1910/65 115mm

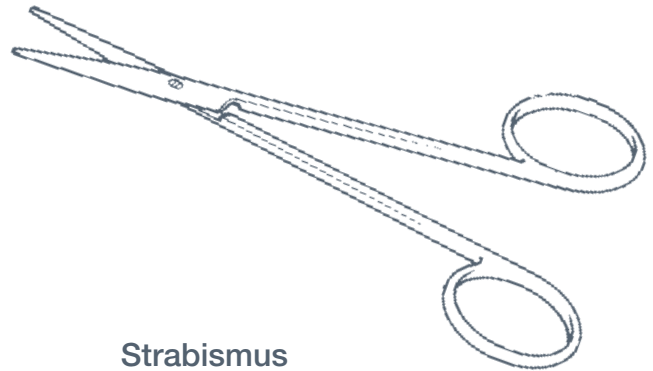

### Strabismus

straight

1912/05 90mm

1912/10 110mm

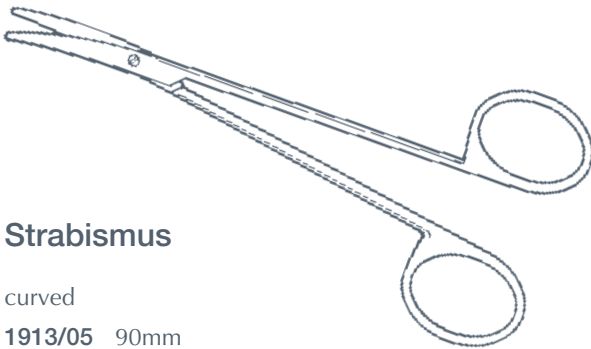

### Strabismus

curved

1913/05 90mm

1913/10 110mm

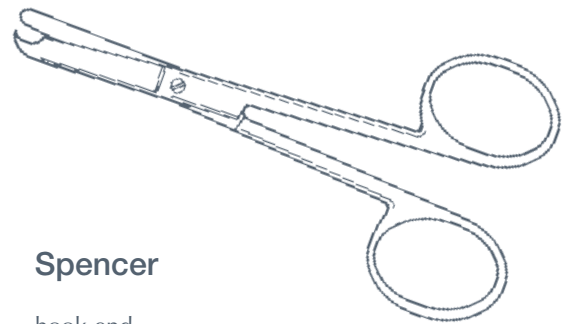

### Spencer

hook end

1914/05 105mm



### Universal Bandage

saw edge, autoclavable handles

1917/05 175mm

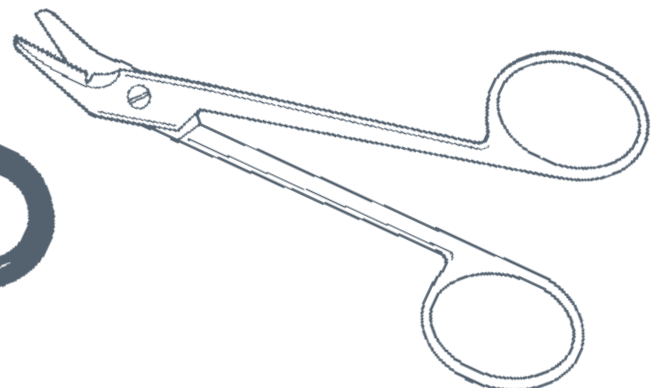

### Universal Wire Cutting

saw edge

1920/05 120mm



### HARD EDGE SCISSORS

The Hard Edge scissors shown on pages 50-52 are made from a special alloy which guarantees long life however frequently the scissors are used, together with a smooth accurate and consistent cutting action.

The extreme hardness results in less frequent sharpening and so minimises the time "out of service" from the operating theatre. (Should the scissors ever need sharpening it is recommended that they are only re-sharpened by the manufacturers who are familiar with the specialist techniques involved in the design.)

Gold plated finger rings allow clear and positive identification.

S Murray's Hard Edge instruments all carry a minimum guarantee period of 3 years, subject to proper usage.

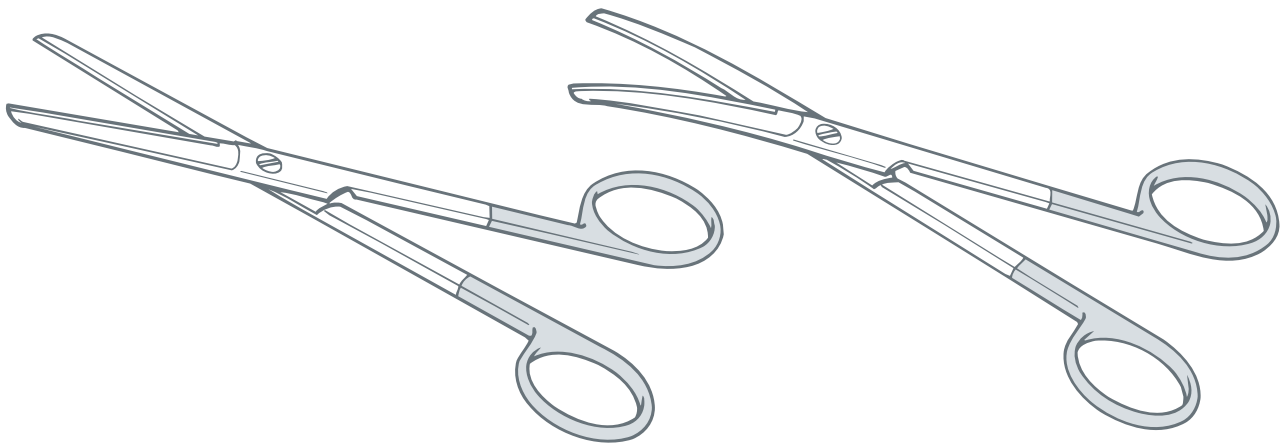

#### Dressing

straight, blunt/blunt  
1923/05 145mm



straight, blunt/sharp  
1924/05 145mm

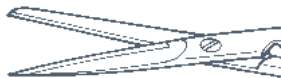

straight, sharp/sharp  
1925/05 145mm



#### Dressing

curved, blunt/blunt  
1926/05 145mm

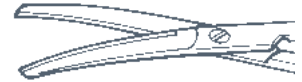

curved, blunt/sharp  
1927/05 145mm



curved, sharp/sharp  
1928/05 145mm

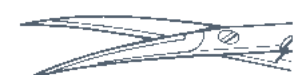





## HARD EDGE SCISSORS

GEN

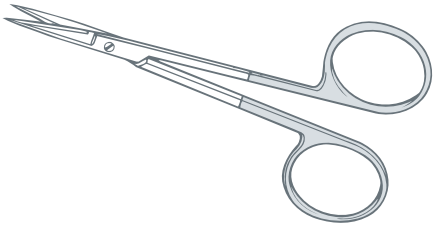

### Iris

straight, sharp

**1929/05** 115mm



curved, sharp

**1930/05** 115mm

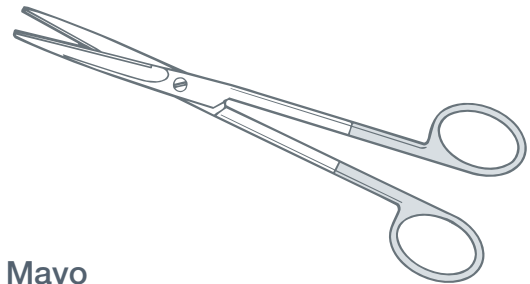

### Mayo

straight, flat blades

**1931/05** 145mm

**1931/10** 170mm

**1931/15** 190mm



curved, flat blades

**1932/05** 145mm

**1932/10** 170mm

**1932/15** 190mm

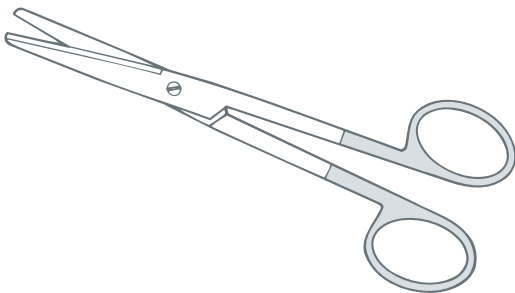

### Mayo-Stille

straight, round blades

**1934/05** 150mm

**1934/10** 170mm



curved, round blades

**1935/05** 150mm

**1935/10** 170mm

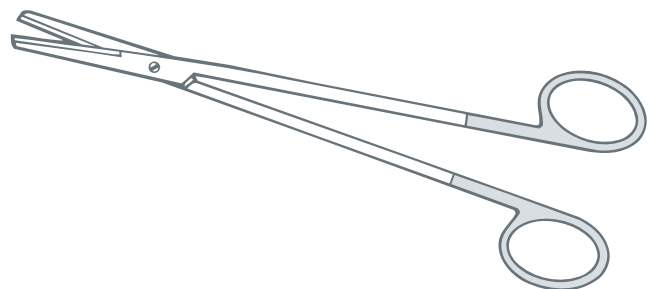

### Metzenbaum

straight, blunt/blunt

**1938/05** 145mm

**1938/10** 180mm

**1938/15** 200mm

**1938/20** 230mm



### HARD EDGE SCISSORS

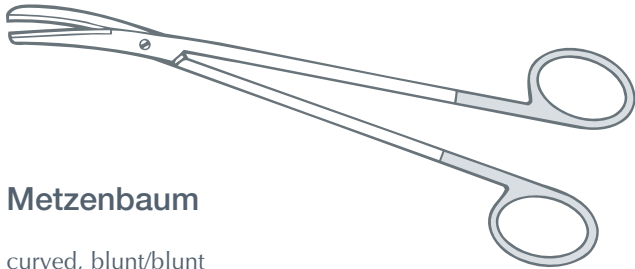

**Metzenbaum**

curved, blunt/blunt

1939/05 145mm

1939/10 180mm

1939/15 200mm

1939/20 230mm

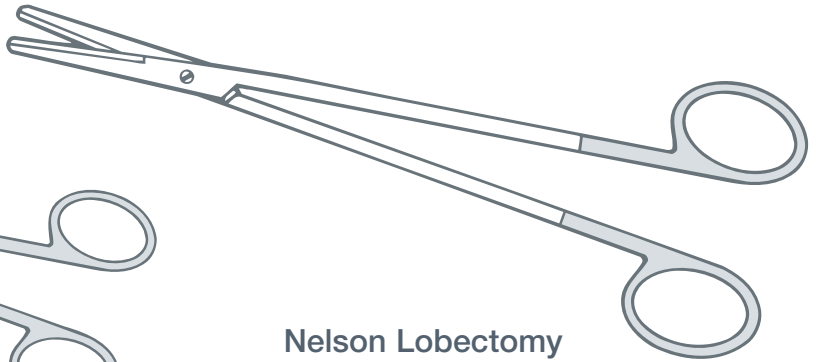

**Nelson Lobectomy**

straight

1945/05 230mm

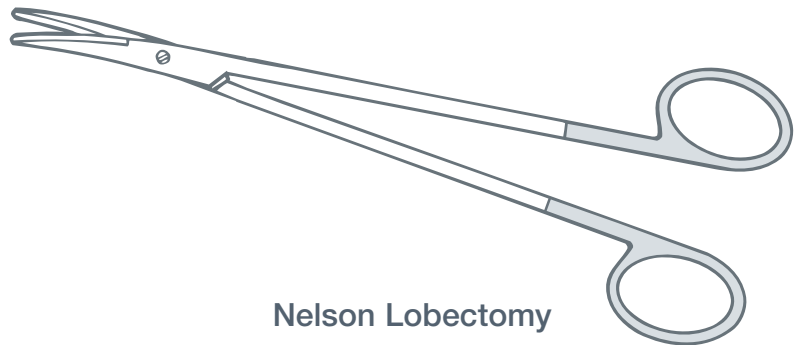

**Nelson Lobectomy**

curved

1946/05 230mm



**Universal Wire Cutting**

1947/05 120mm

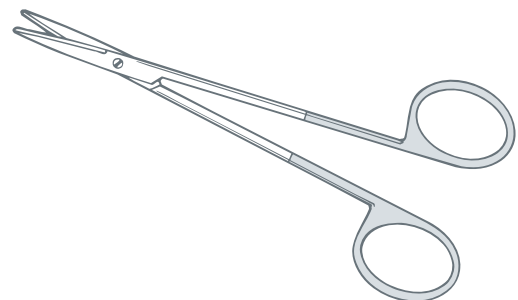

**Strabismus**

straight

1948/05 110mm



curved

1949/05 110mm





### SCISSORS, ULTRA-CUTTING

The Ultracut Scissors shown on pages 53 and 54 are designed to give an effortless cutting action through the full length of the blade.

The bottom blades are ground to a razor edge suitable for all materials from fine tissue to coarse bandages.

The serrated top blades prevent tissue slippage ensuring minimal damage.

A durable black coating on the handles allows easy recognition.

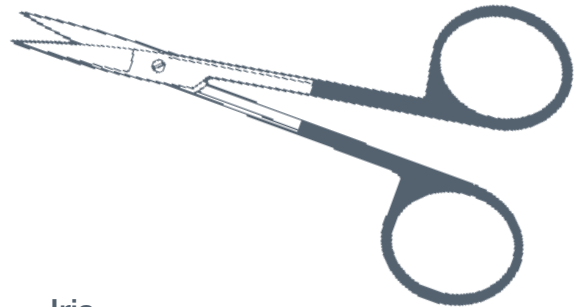
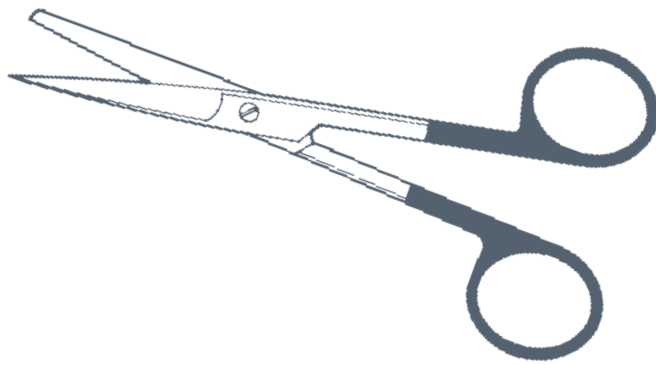

#### Dressing

straight, blunt/sharp  
1950/05 145mm



curved, blunt/sharp  
1951/05 145mm



#### Iris

straight  
1955/05 115mm



curved  
1956/05 115mm

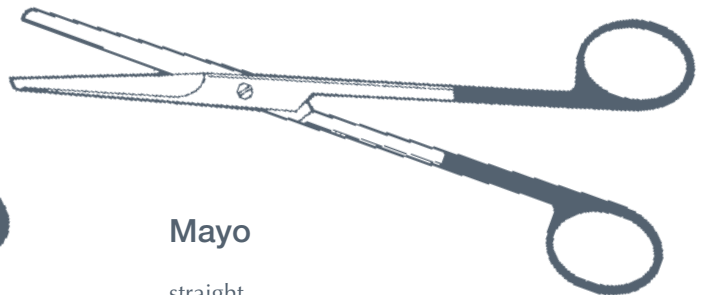
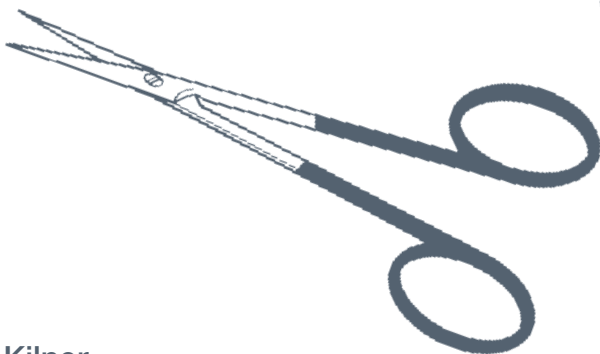

#### Kilner

straight, sharp  
1957/05 110mm



curved, blunt  
1958/05 110mm

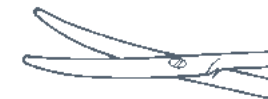

#### Mayo

straight  
1965/05 145mm  
1965/10 170mm  
1965/12 200mm  
1965/15 215mm



curved  
1966/05 145mm  
1966/10 170mm  
1966/12 200mm  
1966/15 215mm

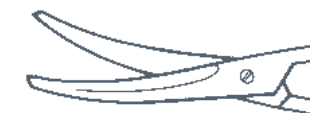



### SCISSORS, ULTRA-CUTTING

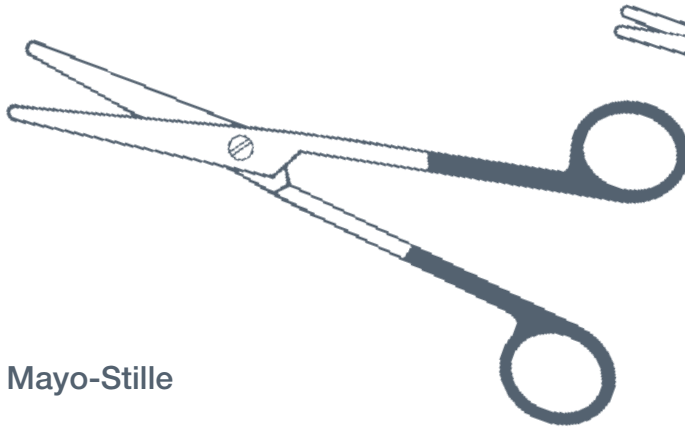

#### Mayo-Stille

straight, round blades

1967/05 150mm

1967/10 170mm

1967/15 190mm

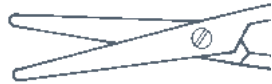

curved, round blades

1968/05 150mm

1968/10 170mm

1968/15 190mm

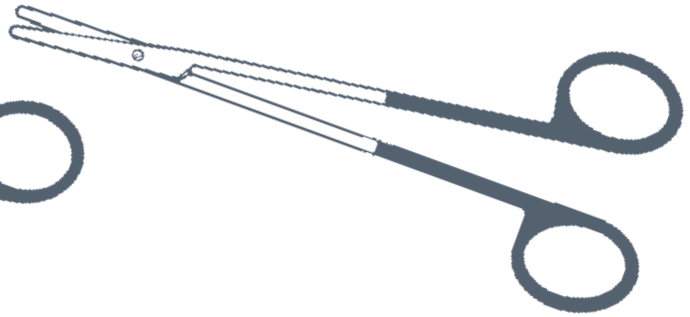

#### Metzenbaum

straight

1970/05 145mm

curved

1971/05 145mm

1971/10 180mm

1971/15 200mm

1971/20 230mm

1971/25 260mm

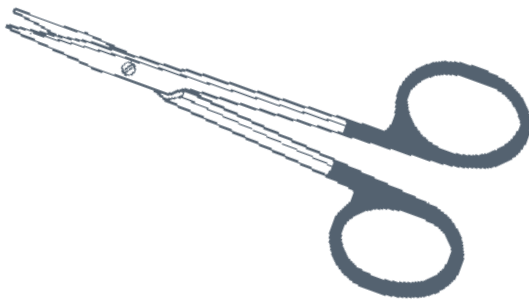

#### Stevens

straight, blunt

1972/25 110mm

curved, blunt

1972/50 110mm

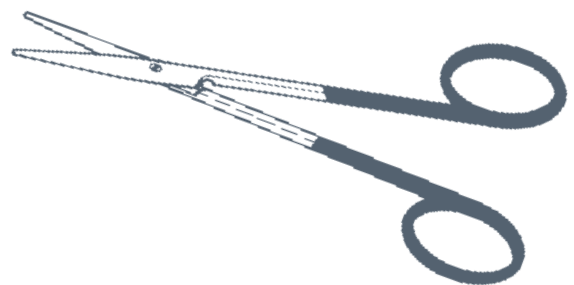

#### Strabismus

straight

1973/05 110mm

curved

1974/05 110mm





## SINUS FORCEPS

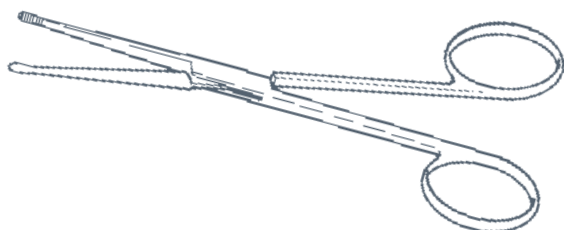

### Lister

serrated tip

1999/05 125mm

1999/10 150mm

1999/15 180mm

1999/20 200mm

## SPHYGMOMANOMETERS

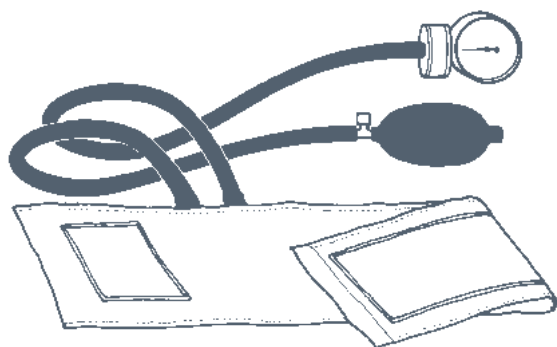

### Aneroid

with velcro cuff in black zip-up case, made in Taiwan

2060/01 complete

2060/21 spare cuff, velcro

2060/23 spare bladder

2060/25 spare bulb

2060/26 spare control valve

2060/27 spare end valve

2060/30 spare gauge

2060/31 spare case

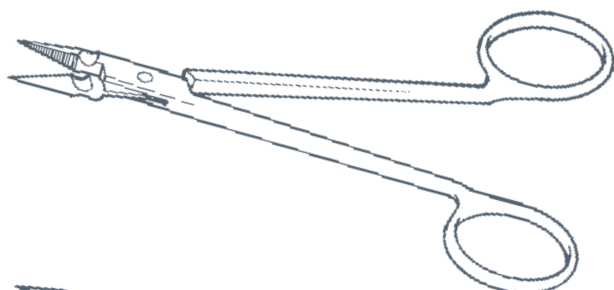

### Arthur

pointed serrated jaws

2062/05 125mm

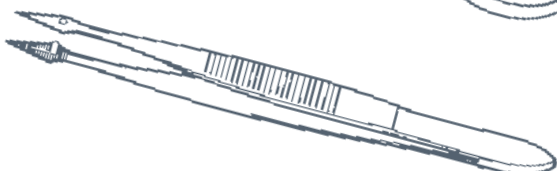

### Hunter

straight

2065/05 105mm

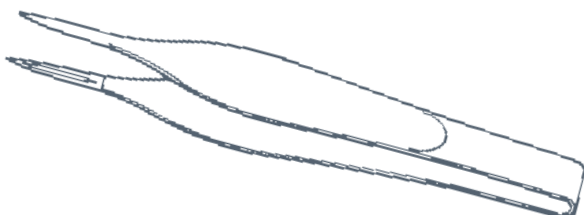

### Martin

2066/05 75mm

2066/10 90mm

2066/15 115mm



### SPONGE HOLDING FORCEPS

#### Foerster

straight, serrated jaws  
 2068/05 180mm  
 2068/10 240mm

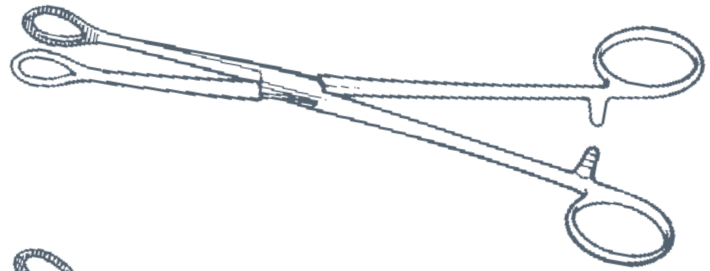

#### Foerster

curved, serrated jaws  
 2069/05 180mm  
 2069/10 240mm

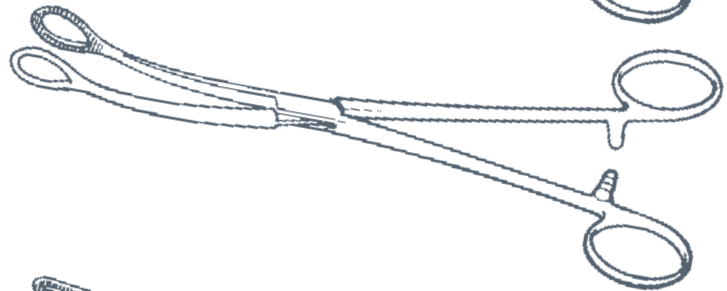

#### Rampléy

straight, serrated jaws  
 2071/05 180mm  
 2071/10 240mm

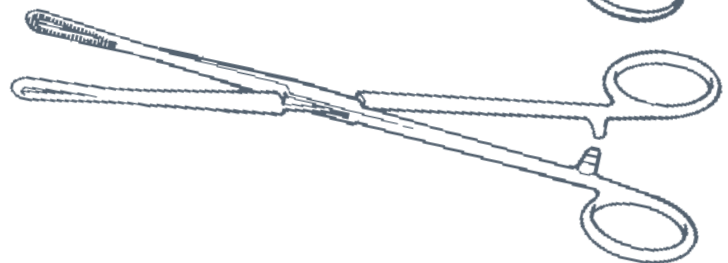

### STERILISER FORCEPS

#### Cheatle

light, box joint  
 2073/50 265mm

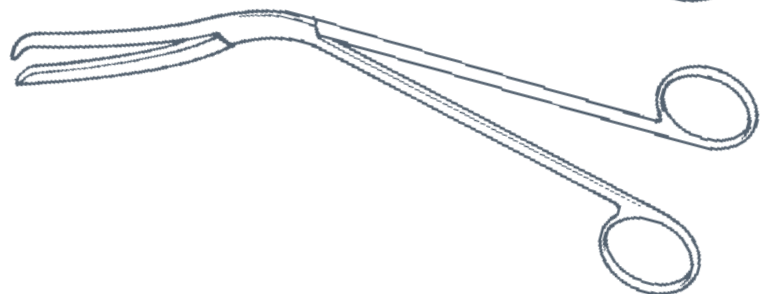

### STETHOSCOPES

#### Nurse

single head, made in Taiwan  
 2080/01 complete



#### Popular

dual head, made in Taiwan  
 2081/01 complete



#### Spare Parts

2089/21 tubing, various colours  
 2089/22 headframe, binaural  
 2089/23 ear nibs, pair

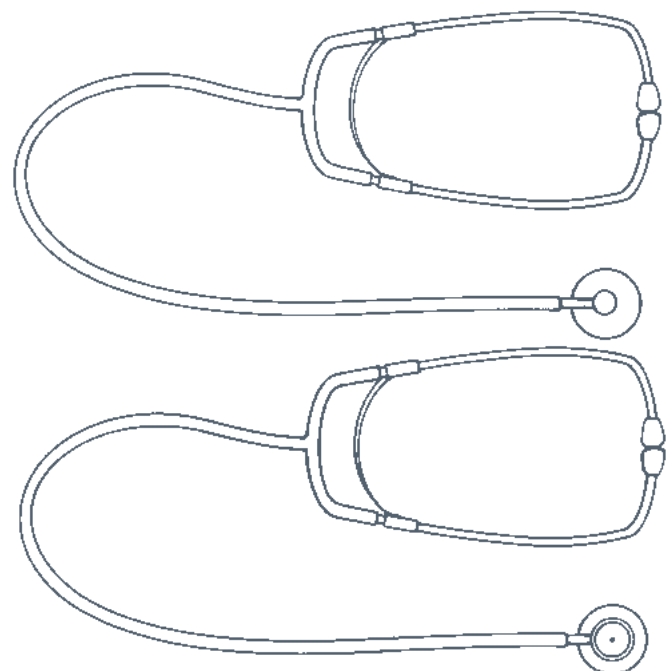



## SUCTION TUBES

GEN



### American Pattern

with stilette

2093/05 chrome plated



### Poole

chrome plated, curved

2110/05 240mm

chrome plated, straight

2110/10 240mm



Lawrie Extension

2111/05 175mm

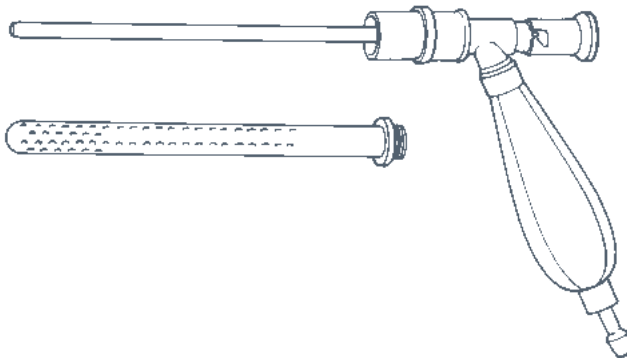

### Tinckler (Simpson Smith)

with on/off valve, removeable perforated  
outer sheath and handle

2115/05 150mm x 255mm

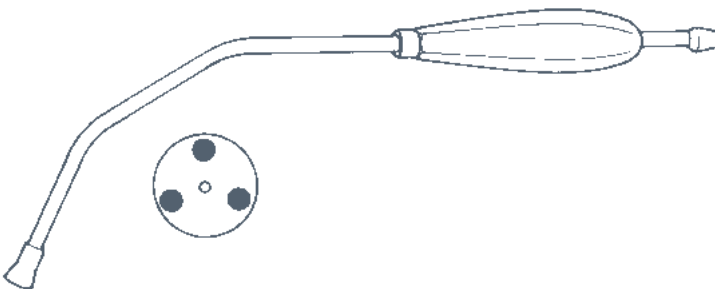

### Yankauer

chrome plated

2125/05 305mm

2125/20 spare rose

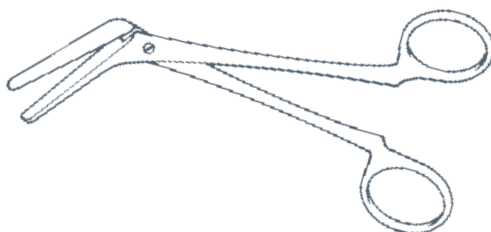

## SUTURE FORCEPS

### Guy's

angled flat blades, screw joint

2130/05 150mm



## TISSUE FORCEPS

### Allis

- 150mm
- 2135/02 2/3 teeth
- 2135/05 3/4 teeth
- 2135/10 4/5 teeth
- 2135/15 5/6 teeth
- 2135/20 6/7 teeth

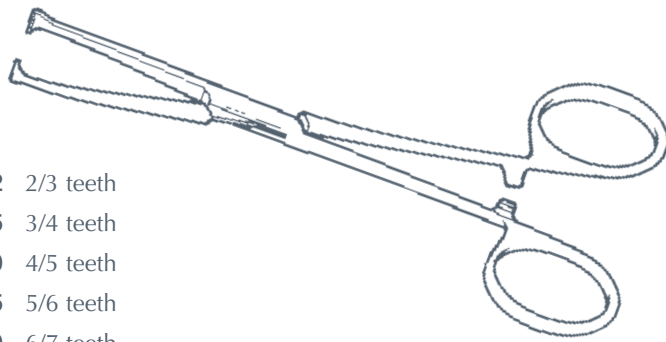

### Allis (American Pattern)

- 160mm
- 2140/05 3/4 teeth

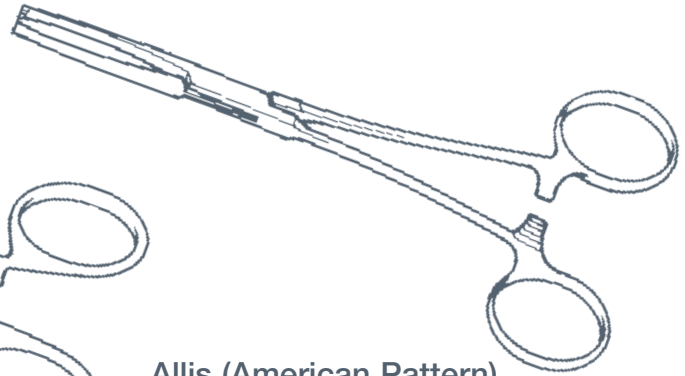

### Babcock

- serrated jaws
- 2145/05 165mm
- 2145/10 200mm
- 2145/15 230mm

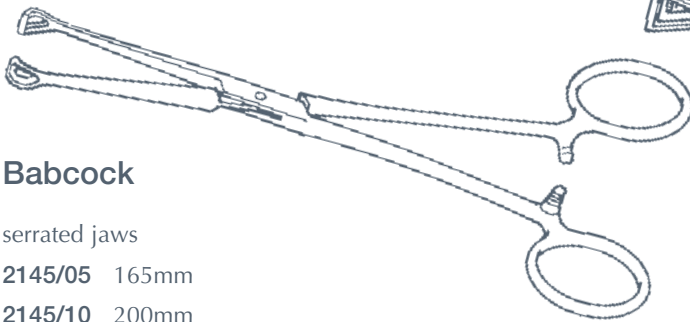

### Duval

- serrated
- 2165/05 190mm, 13mm jaws

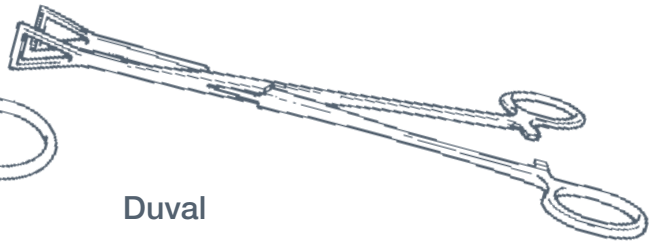

### Judd-Allis

- 195mm
- 2175/05 3/4 teeth

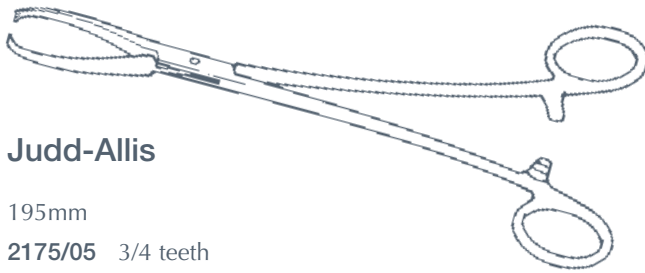

### Lanes

- 1/2 teeth fenestrated
- 2180/05 125mm
- 2180/10 150mm
- 2180/15 195mm

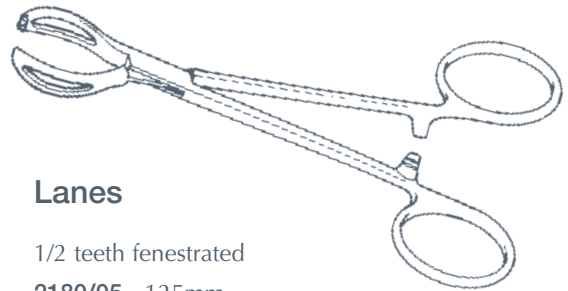

### Littlewood

- 2/3 teeth
- 2185/05 190mm

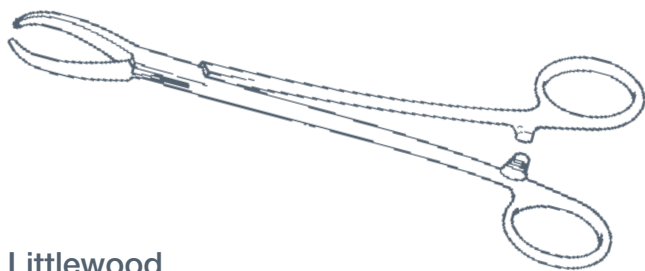

### Poirier

- 2/3 teeth, screw joint
- 2189/05 125mm

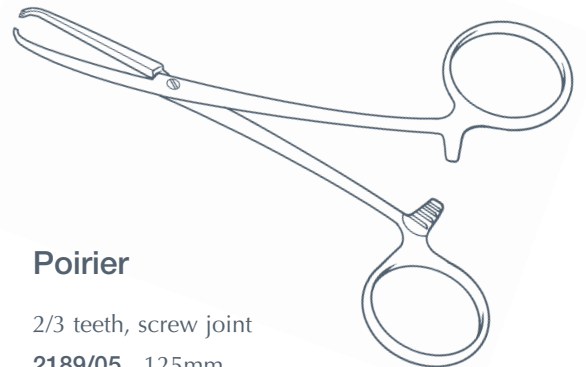





### TISSUE FORCEPS

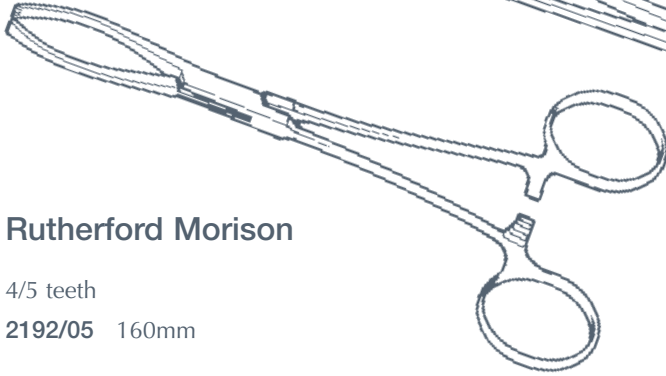

**Rutherford Morison**

4/5 teeth  
2192/05 160mm



**Stiles**

6/7 teeth  
2193/05 205mm

### TONGUE FORCEPS

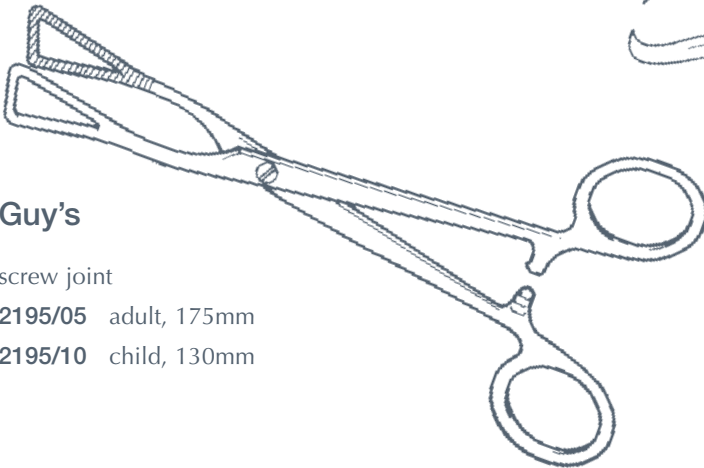

**Guy's**

screw joint  
2195/05 adult, 175mm  
2195/10 child, 130mm

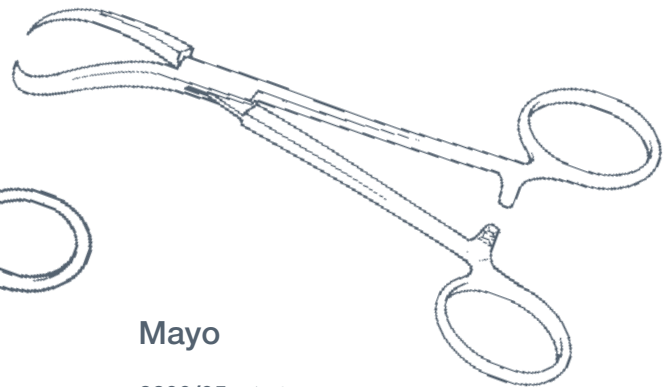

**Mayo**

2200/05 140mm

### TOWEL CLIPS

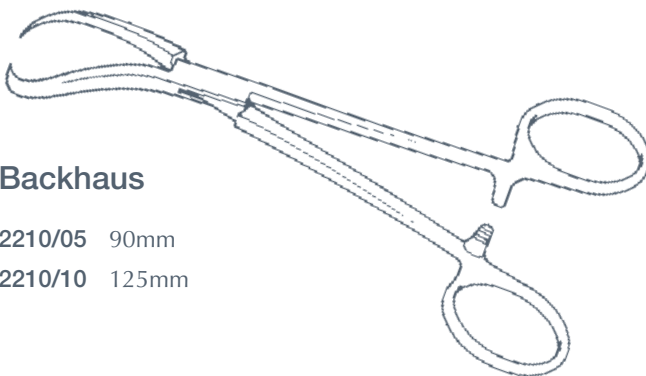

**Backhaus**

2210/05 90mm  
2210/10 125mm

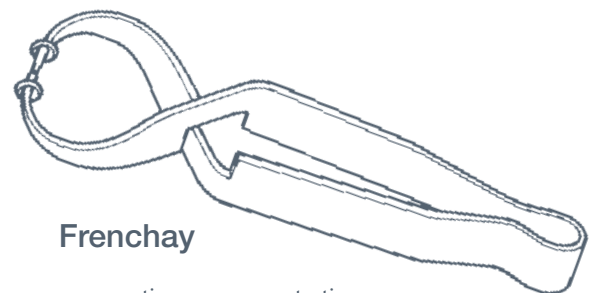

**Frenchay**

cross action, non-penetrating  
2220/05 90mm

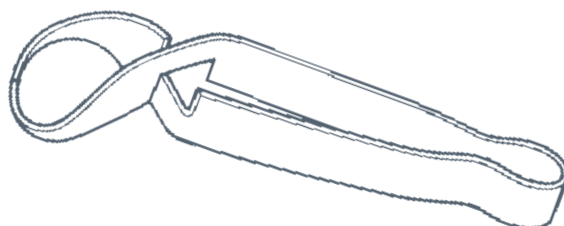

**Shardle**

cross action  
2230/05 90mm



## TUBING CLAMPS

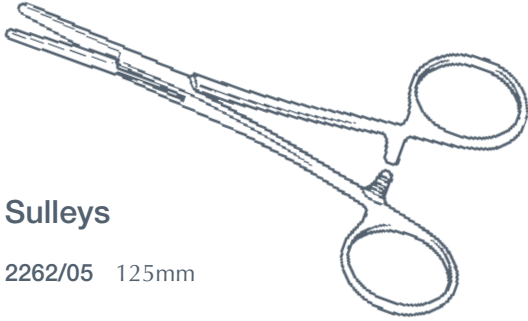

**Sulleys**

2262/05 125mm

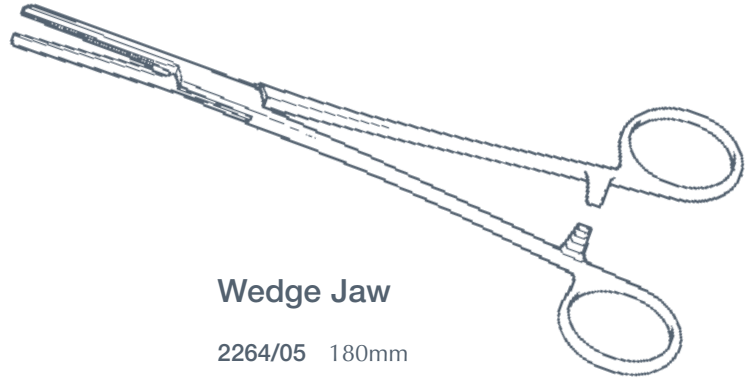

**Wedge Jaw**

2264/05 180mm

2264/10 200mm

## VASECTOMY CLAMPS

### Ring Type

140mm

2265/03 3.0mm

2265/05 3.5mm

2265/10 4.0mm

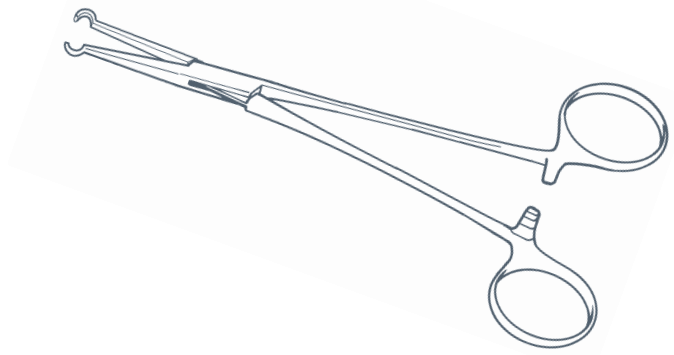

## VASECTOMY FORCEPS

### Curved, Sharp

2267/05 140mm

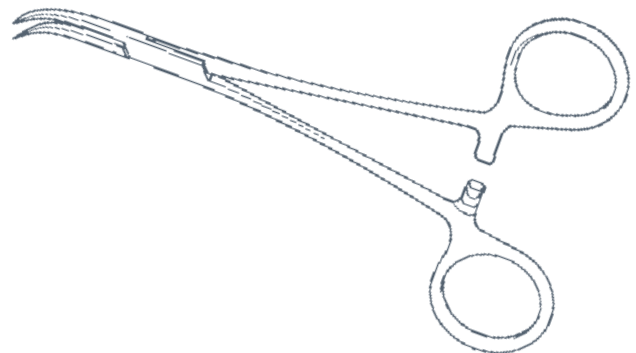



### HOLLOWWARE

#### Forceps Jar

stainless steel, diameter x height:

2270/05	50mm x 100mm
2270/10	75mm x 175mm
2270/15	100mm x 200mm

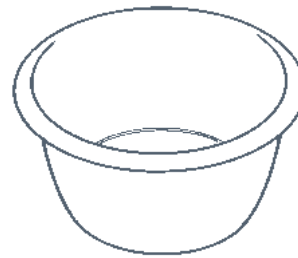
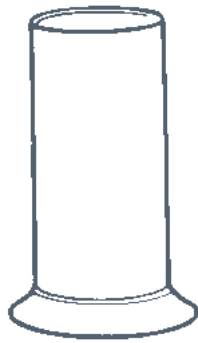

#### Gallipot

stainless steel, capacity, diameter x depth:

2273/05	57ml,	64mm x 35mm
2273/10	113ml,	76mm x 44mm
2273/15	170ml,	82mm x 49mm
2273/20	255ml,	95mm x 57mm

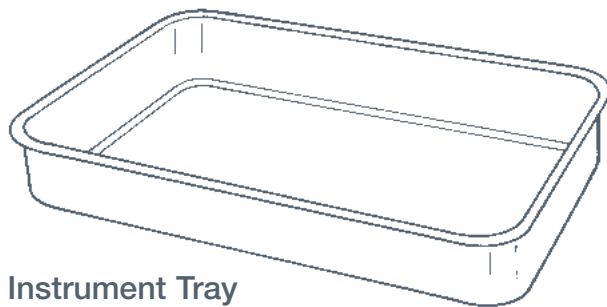

#### Instrument Tray

stainless steel, length x width x depth:

2275/05	220mm x 170mm x 50mm
2275/10	275mm x 220mm x 50mm
2275/15	325mm x 250mm x 50mm
2275/20	325mm x 275mm x 50mm
2275/25	375mm x 275mm x 50mm
2275/30	375mm x 325mm x 50mm

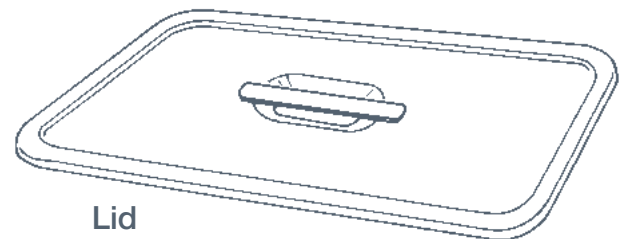

#### Lid

for use with instrument trays

stainless steel, length x width:

2275/06	220mm x 170mm
2275/11	275mm x 220mm
2275/16	325mm x 250mm
2275/21	325mm x 275mm
2275/26	375mm x 275mm
2275/31	375mm x 325mm

#### Jug, Graduated

stainless steel, capacity, diameter x height:

2278/05	250ml,	83mm x 97mm
2278/10	500ml,	95mm x 115mm
2278/15	1000ml,	127mm x 136mm

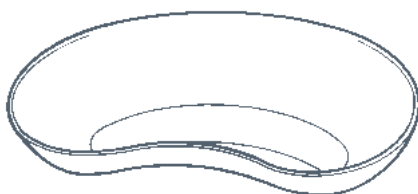

#### Kidney Dish

stainless steel, length x width x depth:

2281/05	152mm x 76mm x 30mm
2281/10	203mm x 102mm x 41mm
2281/15	255mm x 127mm x 51mm
2281/20	305mm x 150mm x 60mm

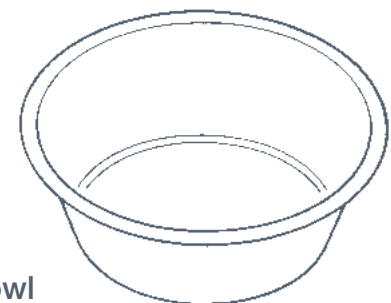

#### Lotion Bowl

stainless steel, capacity, diameter x depth:

2285/05	250ml,	100mm x 45mm
2285/10	500ml,	125mm x 55mm
2285/15	900ml,	150mm x 65mm
2285/20	2000ml,	205mm x 90mm
2285/25	4000ml,	255mm x 110mm
2285/30	7000ml,	350mm x 135mm



THO

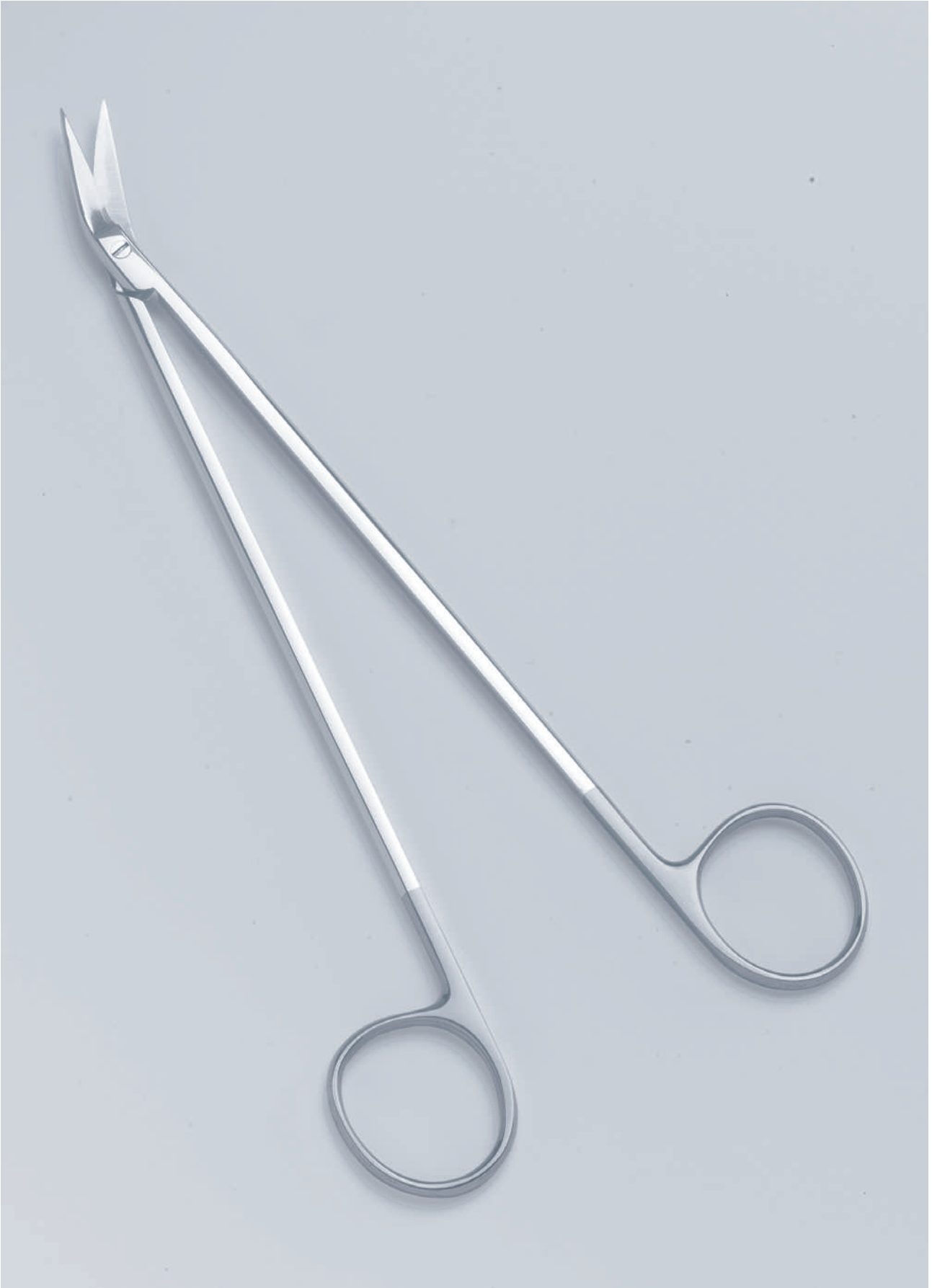



## ARTERY FORCEPS

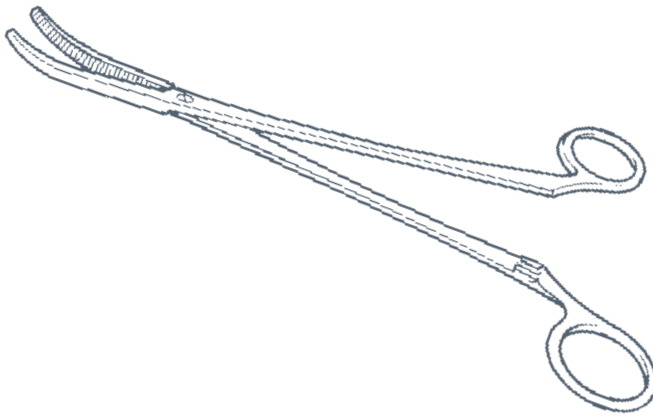

### Roberts

curved on flat, box joint

2525/05 230mm

curved on flat, screw joint

2526/05 230mm

## BIOPSY PUNCH

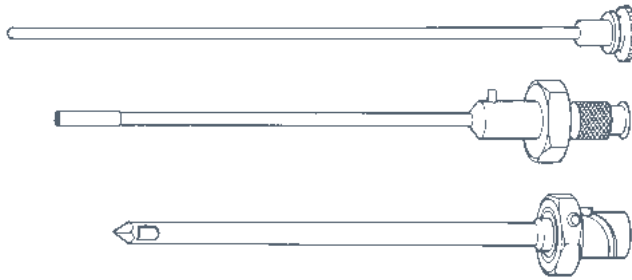

### Abrams Pleural

outer needle with trocar point, inner needle and stillette. Length 125mm.

2535/05 4mm

## CLAMPS

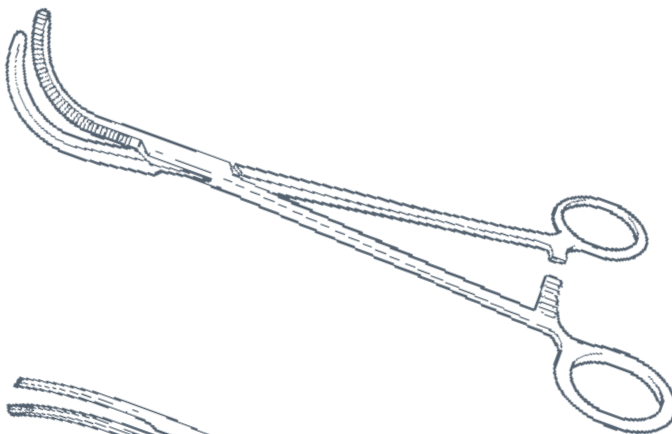

### Crafoord

medium curve

2555/50 240mm

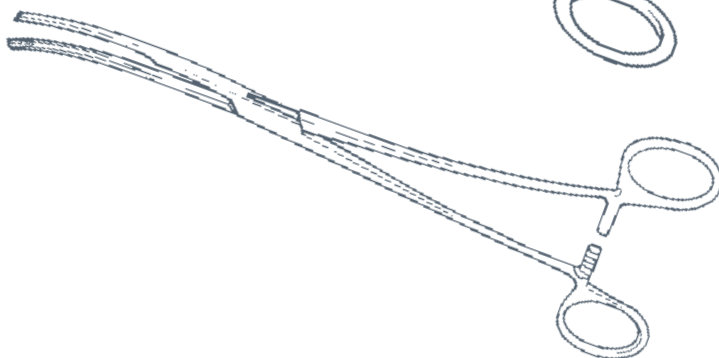

### Semb

pneumonectomy forceps  
slight curve

2585/25 240mm

deep curve

2585/50 240mm



## CLAMPS, ATRAUMATIC

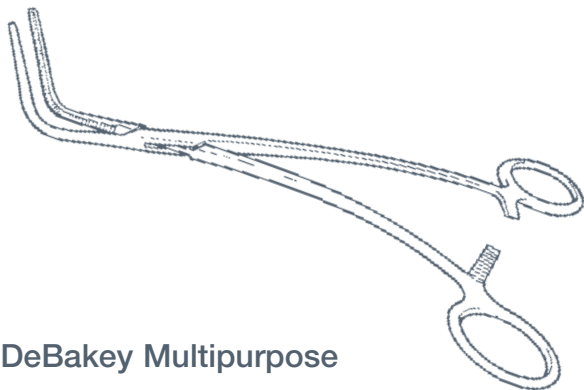

**DeBakey Multipurpose**

right angled, 1/2 serrations, 40mm jaw  
**2625/05** 220mm

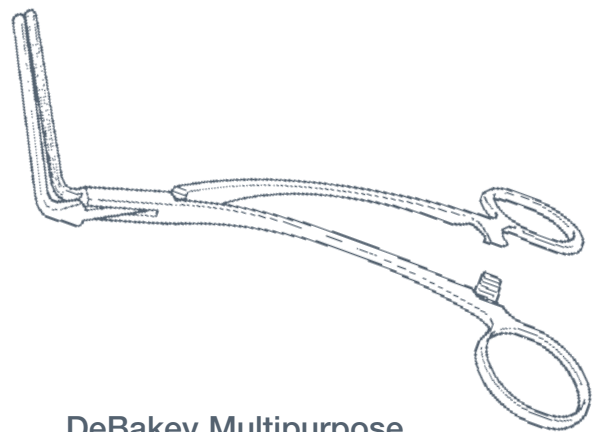

**DeBakey Multipurpose**

right angled, 1/2 serrations, 50mm jaw  
**2625/10** 200mm

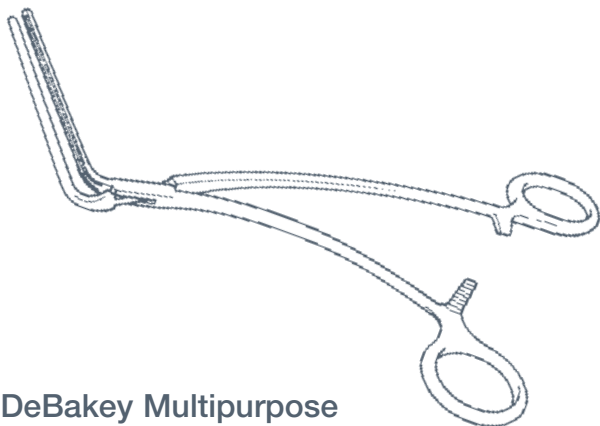

**DeBakey Multipurpose**

right angled, 1/2 serrations, 65mm jaw  
**2625/15** 215mm

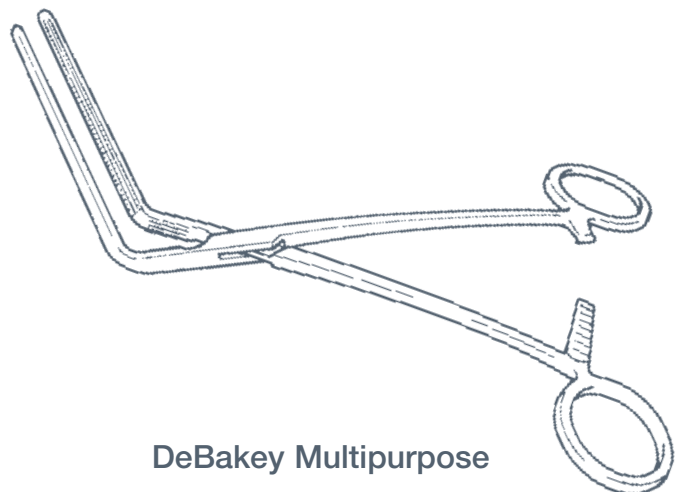

**DeBakey Multipurpose**

right angled, 1/2 serrations, 100mm jaw  
**2625/20** 280mm

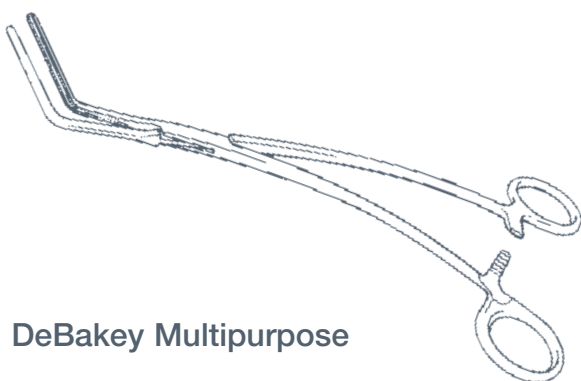

**DeBakey Multipurpose**

obtuse angled, 1/2 serrations, 50mm jaw  
**2626/05** 210mm

obtuse angled, 1/2 serrations, 40mm jaw  
**2626/10** 235mm

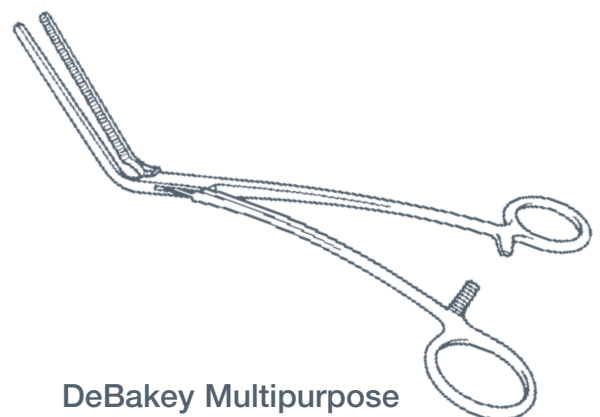

**DeBakey Multipurpose**

obtuse angled, 1/2 serrations, 65mm jaw  
**2626/15** 240mm

obtuse angled, 1/2 serrations, 100mm jaw  
**2626/20** 300mm



## CLAMPS, ATRAUMATIC

THO

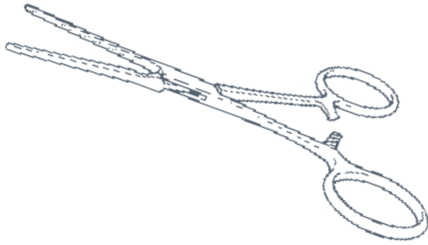

### DeBakey Ring Handle

straight, 1/2 serrations, 45mm jaw  
2630/05 130mm

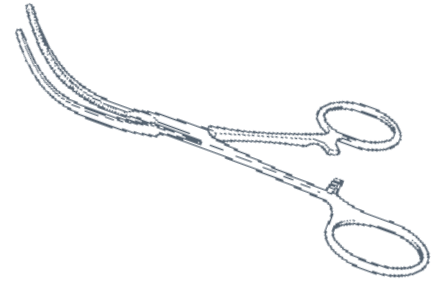

### DeBakey Ring Handle

curved, 1/2 serrations, 45mm jaw  
2631/05 130mm

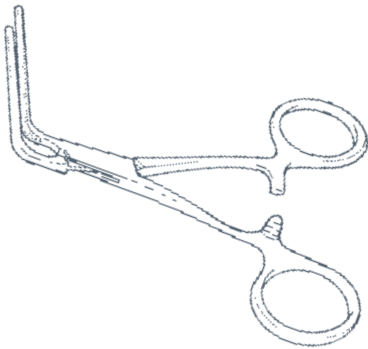

### DeBakey Ring Handle

right angled, 1/2 serrations, 40mm jaw  
2632/05 120mm

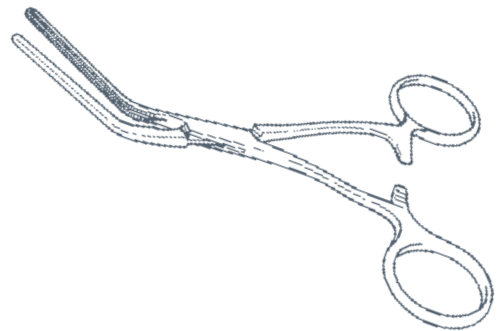

### DeBakey Ring Handle

angled 45°, 1/2 serrations, 40mm jaw  
2633/05 115mm

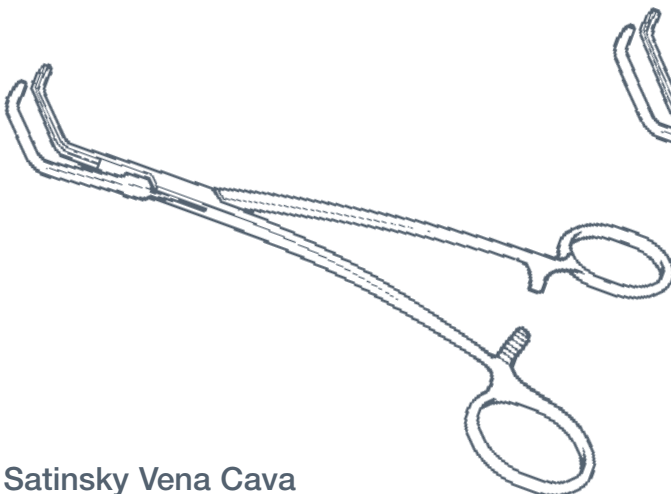

### Satinsky Vena Cava

double angle, 1/2 serrations, 250mm  
2685/05 small, 32mm jaw

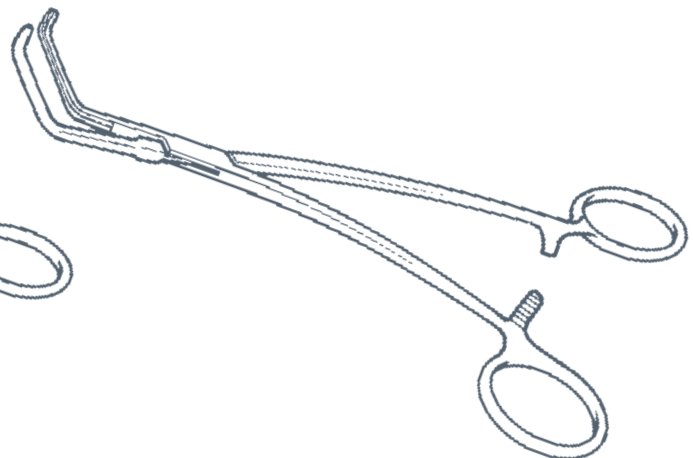

### Satinsky Vena Cava

double angle, 1/2 serrations, 250mm  
2685/10 medium, 40mm jaw



## CLAMPS, ATRAUMATIC

### Satinsky Vena Cava

double angle, 1/2 serrations, 250mm  
2685/15 large, 50mm jaw

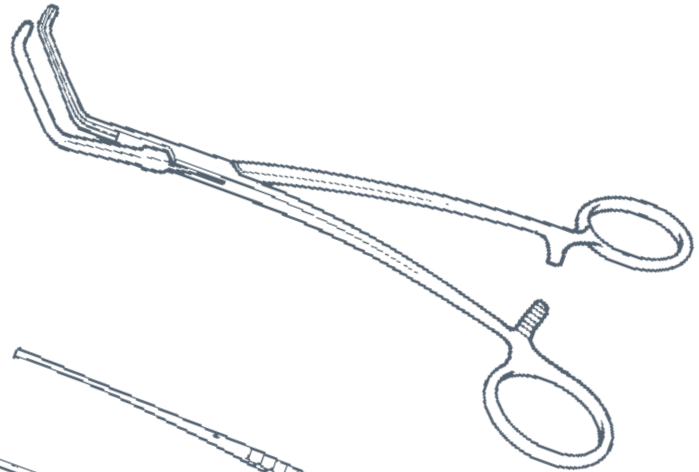

## DISSECTING FORCEPS

### Nelson

fine teeth  
2700/05 230mm

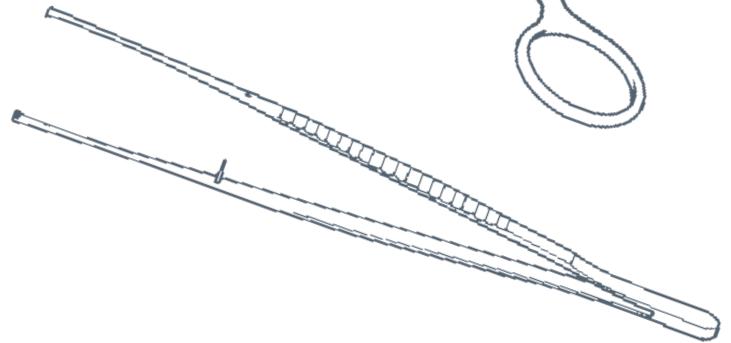

## ELEVATORS

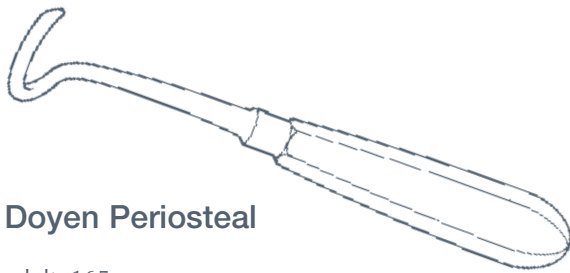

### Doyen Periosteal

adult, 165mm  
2703/25 left  
2703/50 right

child  
2704/25 left  
2704/50 right

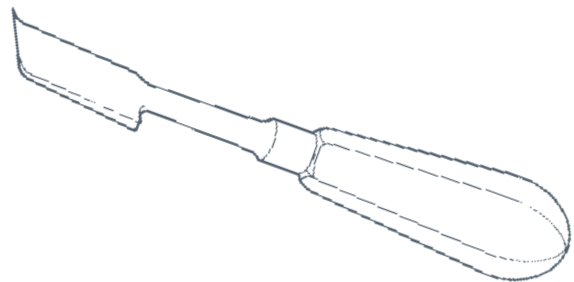

### Tudor Edwards Periosteal

length 175mm  
2705/05 12mm  
2705/10 18mm

## LUNG FORCEPS

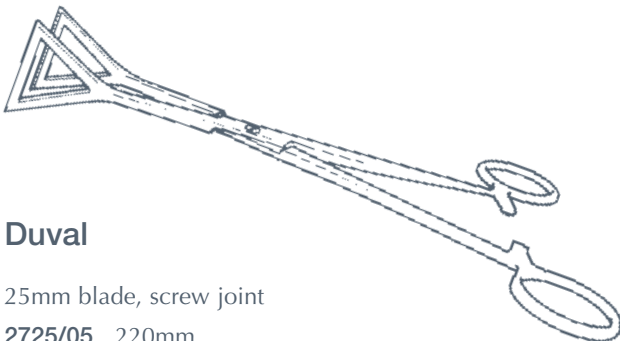

### Duval

25mm blade, screw joint  
2725/05 220mm

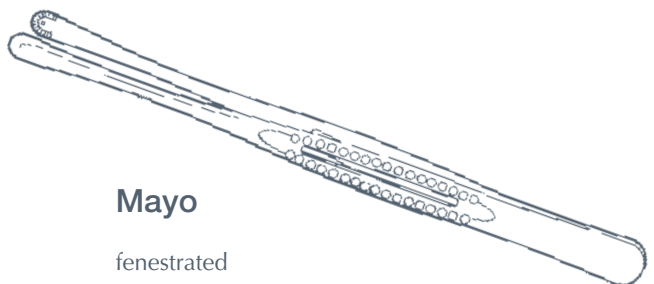

### Mayo

fenestrated  
2730/05 225mm





## RETRACTORS

THO

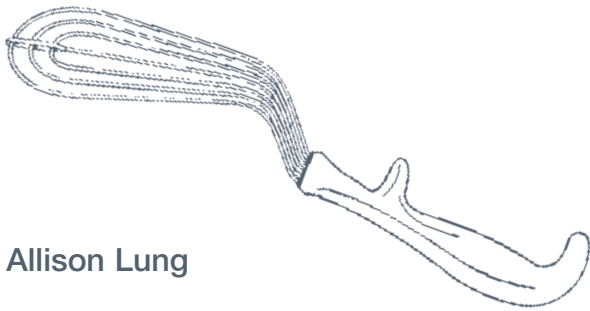

**Allison Lung**

adult  
2750/25 300mm

child  
2750/50 280mm

infant  
2750/75 280mm

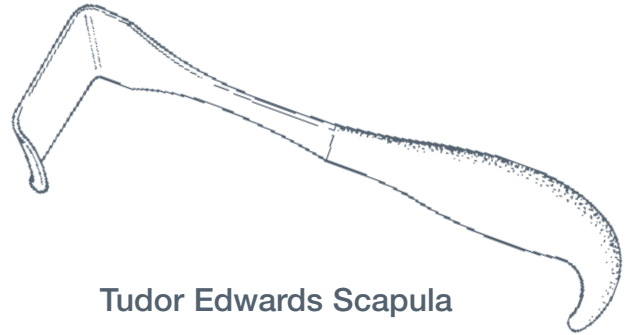

**Tudor Edwards Scapula**

2770/05 200mm, 45mm blade

## RIB SHEARS

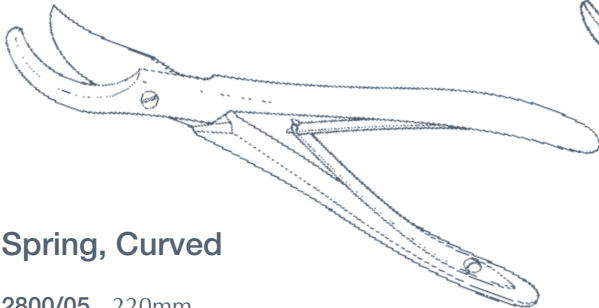

**Spring, Curved**

2800/05 220mm

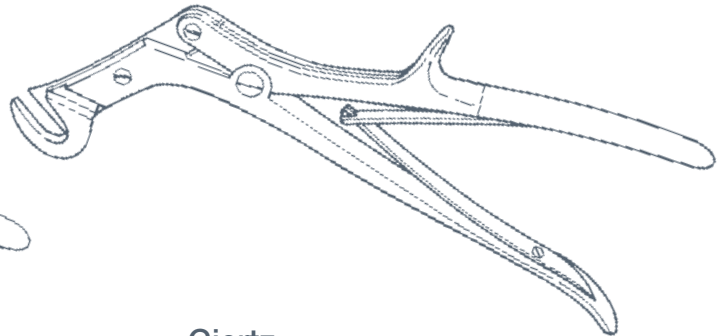

**Giertz**

2785/05 270mm

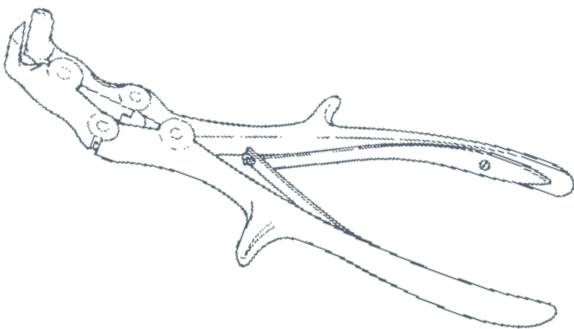

**Tudor Edwards**

compound action, anterior  
2810/05 235mm

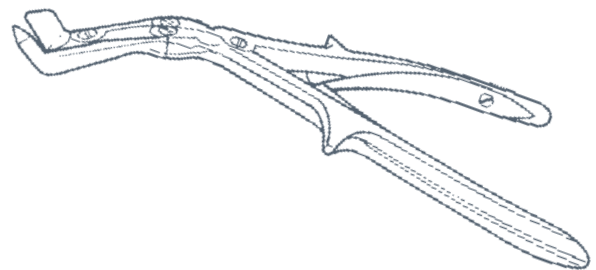

**Tudor Edwards**

compound action, posterior  
2811/05 250mm



## RIB SPREADERS

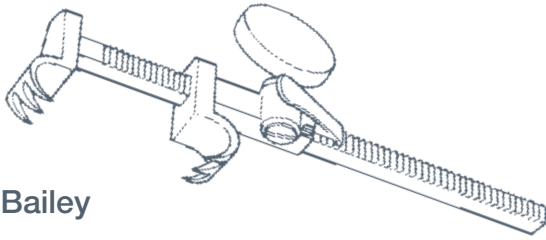

**Bailey**

2820/05 160mm

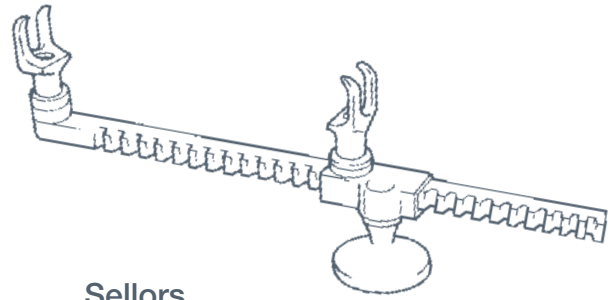

**Sellors**

approximator and spreader combined  
2860/05 200mm

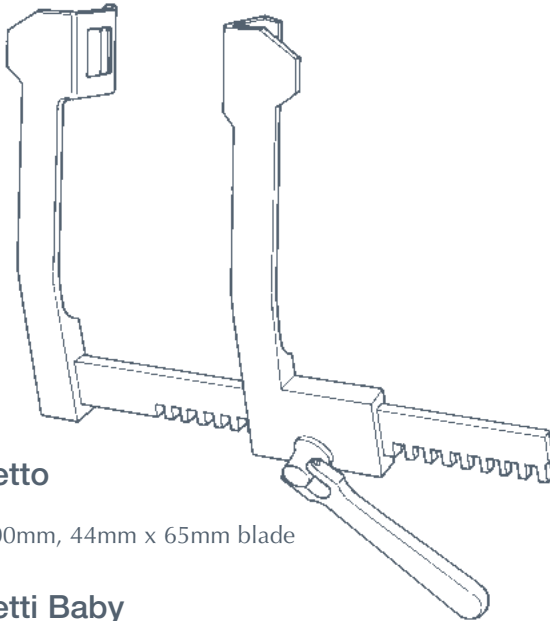

**Finocchietto**

2840/35 300mm, 44mm x 65mm blade

**Finocchietti Baby**

2841/05 105mm, 18mm x 21mm blade

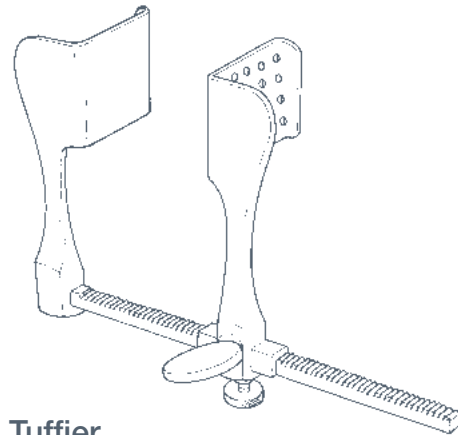

**Tuffier**

2865/05 165mm, 50mm x 45mm blade

## SCISSORS

**Potts-Smith**

angled to side, 190mm  
2890/05 25°

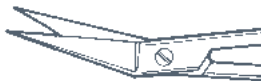

angled to side, 190mm  
2891/05 45°

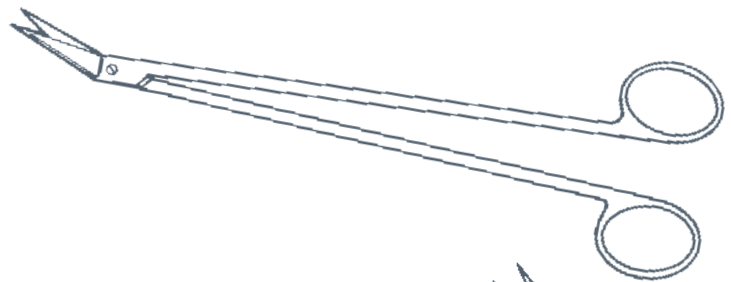
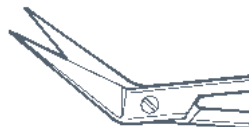

angled to side, 190mm  
2892/05 60°

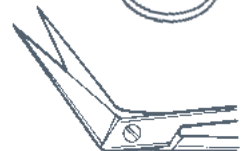

angled to side, 190mm  
2893/05 125°





## SCISSORS, HARD EDGE

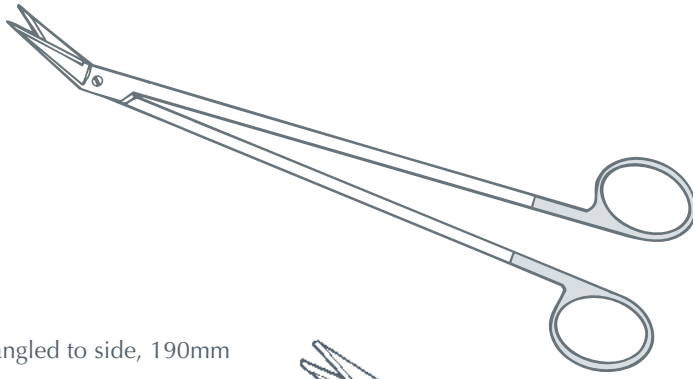

angled to side, 190mm  
2921/05 45°

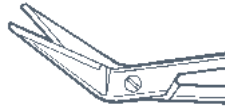

### Potts-Smith

angled to side, 190mm  
2920/05 25°



angled to side, 190mm  
2922/05 60°

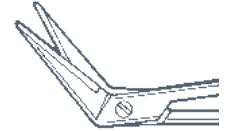

THO

## TISSUE FORCEPS

### DeBakey

atraumatic, 1.5mm jaw  
2940/05 150mm  
2940/10 180mm  
2940/15 195mm  
2940/20 240mm

atraumatic, 2mm jaw  
2941/05 150mm  
2941/10 180mm  
2941/15 195mm  
2941/20 240mm

atraumatic, angled, 2mm jaw  
2942/05 150mm  
2942/10 180mm  
2942/15 195mm  
2942/20 240mm

atraumatic, 2.4mm jaw  
2943/05 150mm  
2943/10 180mm  
2943/15 195mm  
2943/20 240mm

atraumatic, 2.7mm jaw  
2944/05 150mm  
2944/10 180mm  
2944/15 195mm  
2944/20 240mm

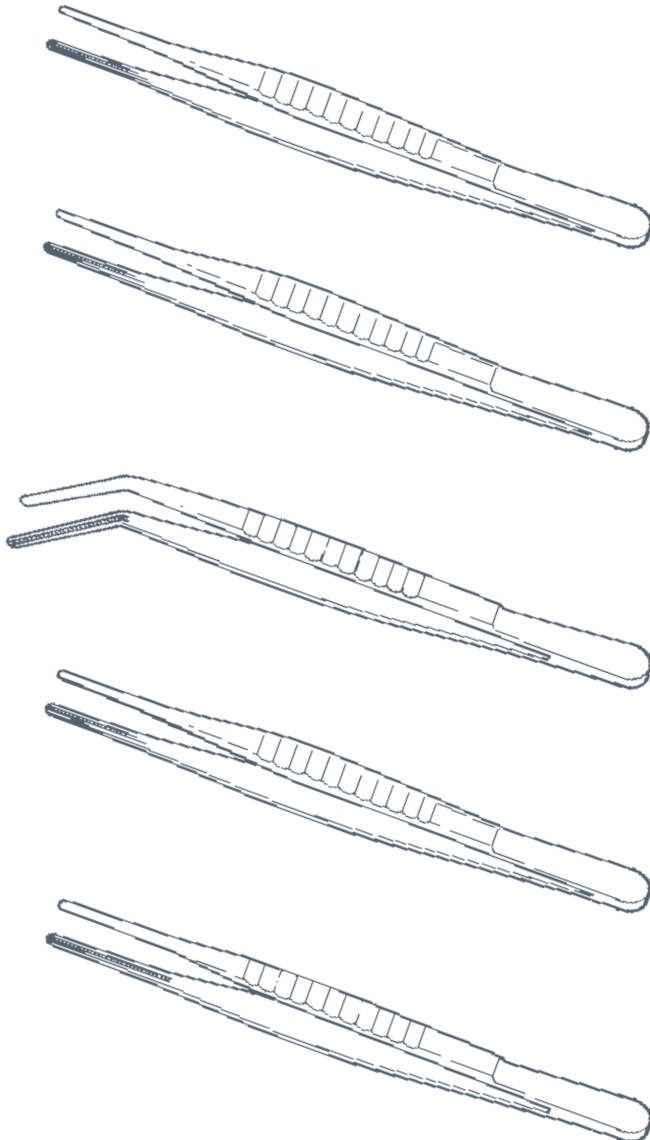



GYN





## BIOPSY PUNCH

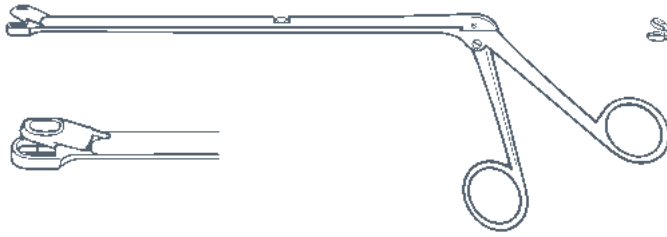

### Eppendorf

3005/05 200mm effective length

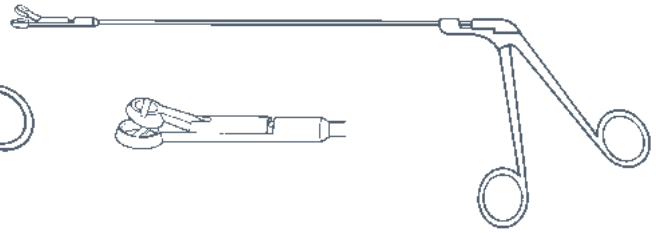

### Leech Wilkinson

3008/05 200mm effective length

GYN

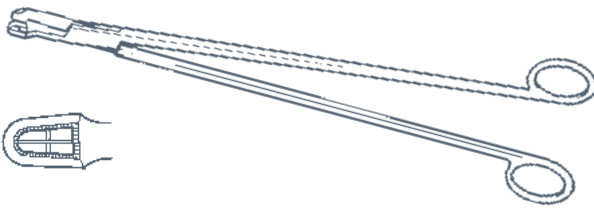

### Schubert

straight

3011/05 210mm

3011/10 290mm

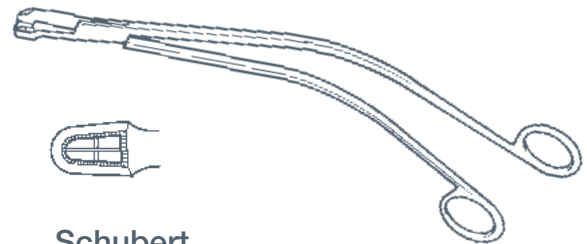

### Schubert

angled shank

3012/05 260mm

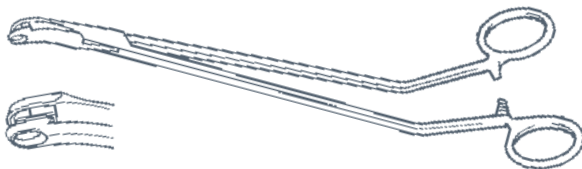

### Van Doren

curved

3015/05 265mm angled shank

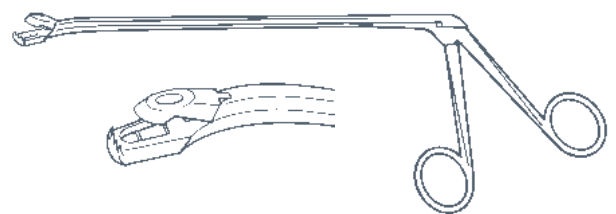

### Wittner

curved to side

3019/05 230mm effective length



## CANNULA

### Leech Wilkinson

luer fitting, complete with stilette, 265mm

3025/05 cone 10mm to 25mm

3025/10 cone 13mm to 30mm

3025/15 cone 16mm to 30mm



### Spackman Intra Uterine

with adjustable plate for use with  
vulsellum forceps, luer fitting  
(forceps must be ordered separately)

3031/05 360mm



### Female

round, with solid end, plated, 165mm

3038/05 6 Eg

3038/10 7 Eg

3038/15 8 Eg

3038/20 9 Eg

3038/25 10 Eg



### Rotunda

oval, with solid end, plated, 200mm

3041/05 8 Eg

3041/10 10 Eg

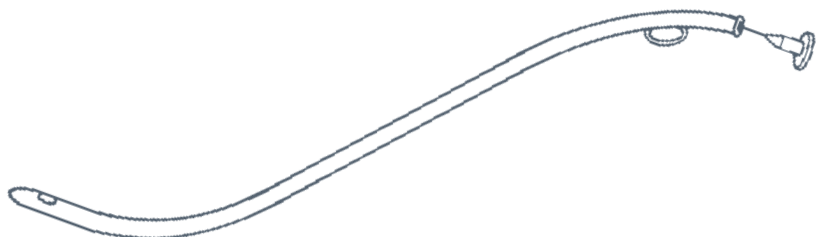



## CLAMPS

GYN

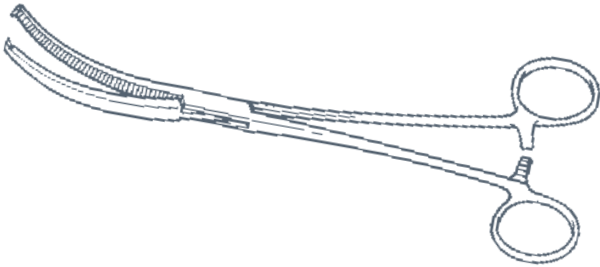

**Berkeley- Bonney Hysterectomy**

curved on flat, 1/2 teeth  
3050/05 200mm

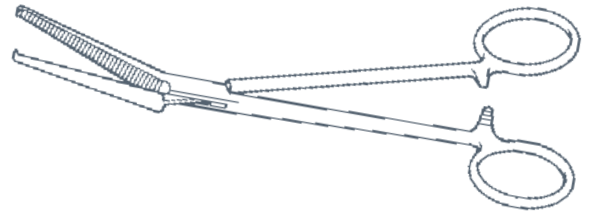

**Bonney Hysterectomy**

angled on flat, 1/2 teeth  
3053/05 195mm



**Bonney Myomectomy**

screw joint  
3056/05 265mm

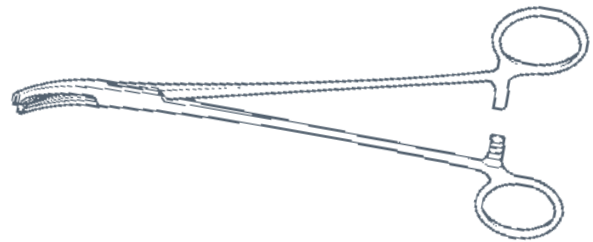

**Faure**

longitudinal serrations, toothed  
3060/05 200mm

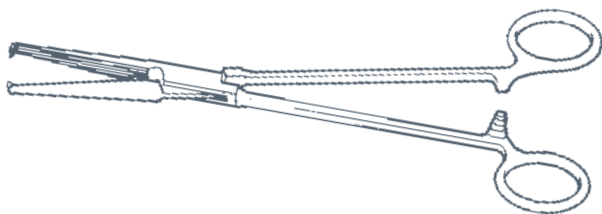
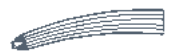

**Gwilliam**

straight, longitudinal serrations,  
1/2 teeth  
3065/05 200mm

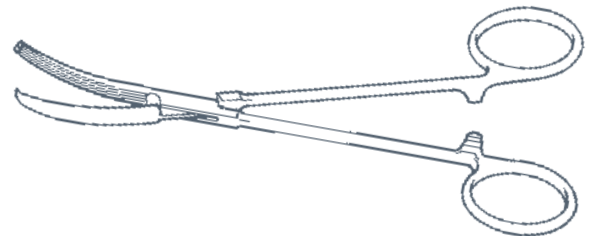
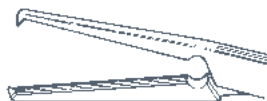

**Gwilliam**

curved on flat, longitudinal serrations,  
1/2 teeth  
3066/05 200mm

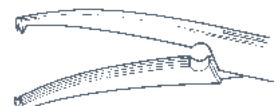



## CLAMPS

### Heaney

curved, single tooth  
3070/10 210mm



curved, double tooth  
3071/10 210mm

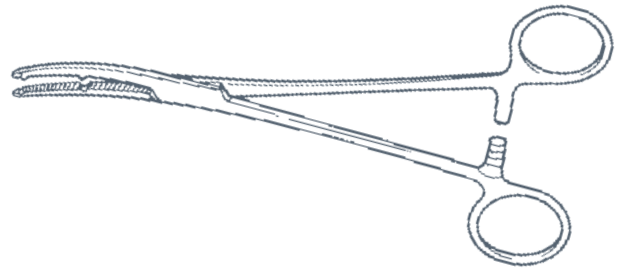

GYN

### Hysterectomy, Atraumatic

straight, 2/3 teeth  
3075/05 220mm  
3075/10 240mm



slight curve, 2/3 teeth  
3076/05 220mm  
3076/10 240mm



full curve, 2/3 teeth  
3077/05 210mm  
3077/10 230mm



angled, 2/3 teeth  
3078/05 210mm  
3078/10 230mm

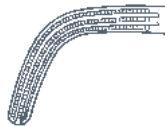

3078/95 set of 8 clamps

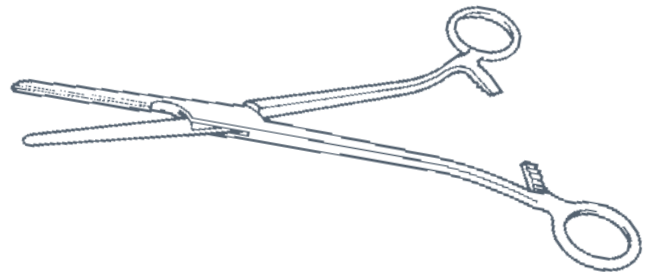

### Maingot

curved on flat, 1/2 teeth  
3085/05 200mm  
3085/10 240mm

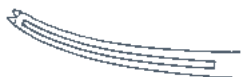

straight, 1/2 teeth  
3086/05 200mm

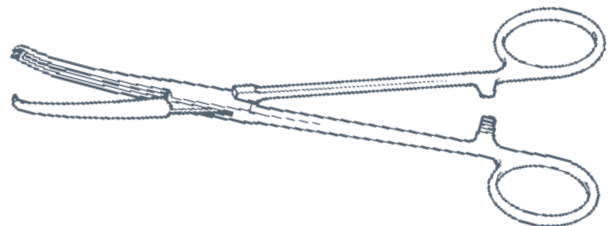





## CURETTES

GYN



### Sharman

endometrial biopsy  
3125/05 220mm

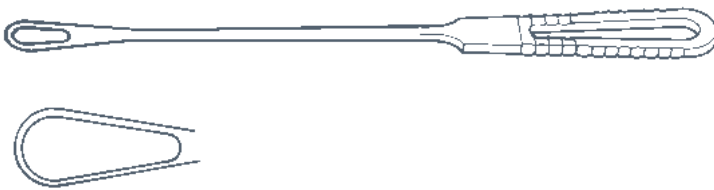

### Sims Uterine

single ended  
blunt, pliable shaft, 255mm  
3130/05 6mm

3130/10 10mm

3130/15 13mm

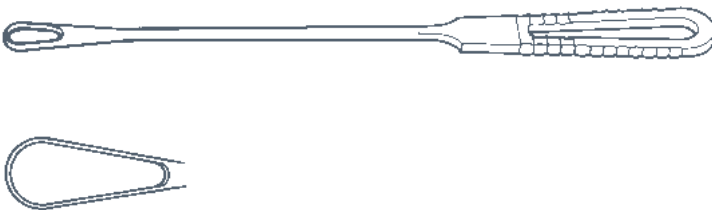

### Sims Uterine

single ended  
sharp, pliable shaft, 255mm  
3131/05 6mm

3131/10 10mm

3131/15 13mm



### Sims Uterine

double ended  
blunt/sharp combined  
3132/05 250mm

sharp/sharp combined  
3133/05 250mm



## DILATORS, CERVIX



### Hegar

single ended, 185mm

<b>3160/05</b>	2mm	<b>3160/50</b>	11mm
<b>3160/10</b>	3mm	<b>3160/55</b>	12mm
<b>3160/15</b>	4mm	<b>3160/60</b>	13mm
<b>3160/20</b>	5mm	<b>3160/65</b>	14mm
<b>3160/25</b>	6mm	<b>3160/70</b>	15mm
<b>3160/30</b>	7mm	<b>3160/75</b>	16mm
<b>3160/35</b>	8mm	<b>3160/80</b>	17mm
<b>3160/40</b>	9mm	<b>3160/95</b>	set of 16 sizes
<b>3160/45</b>	10mm		



### Hegar

double ended, 220mm

<b>3161/05</b>	3/4mm
<b>3161/10</b>	5/6mm
<b>3161/15</b>	7/8mm
<b>3161/20</b>	9/10mm
<b>3161/25</b>	11/12mm
<b>3161/30</b>	13/14mm
<b>3161/35</b>	15/16mm
<b>3161/40</b>	17/18mm
<b>3161/95</b>	set of 8 sizes

GYN

## DRESSING FORCEPS



### Bozemann Uterine

**3170/05** grooved jaw, 265mm

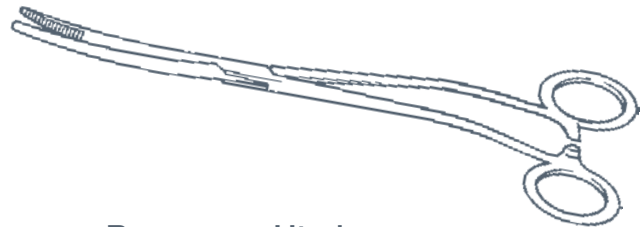

### Bozemann Uterine

**3171/05** serrated jaw, 265mm

## GUIDES

### Pudendal Nerve Block

luer, complete with needle

**3175/05** 140mm





## MYOMA SCREW

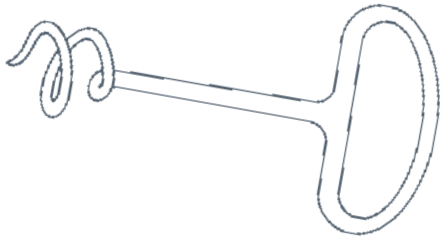

### Doyen

for abdominal use  
3180/05 150mm

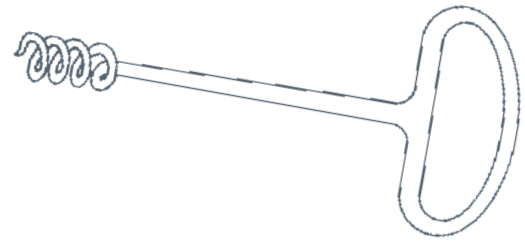

### Doyen

for vaginal use  
3181/05 175mm

GYN

## OBSTETRIC FORCEPS

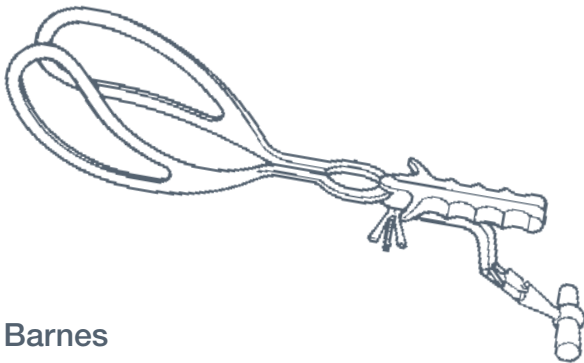

### Barnes

with Simpson handle and Neville axis  
traction rod  
3190/05 410mm

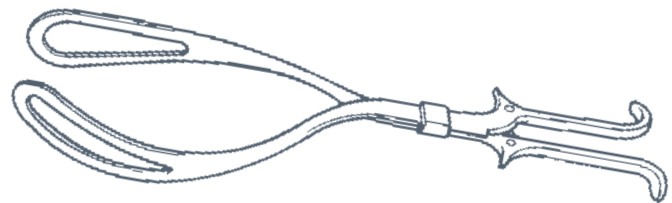

### Kielland

3200/05 410mm



### Simpson

short model  
3205/05 280mm



### Wrigley

short model  
3215/05 250mm



## OVUM FORCEPS

### McClintock

curved, screw joint  
3225/05 240mm

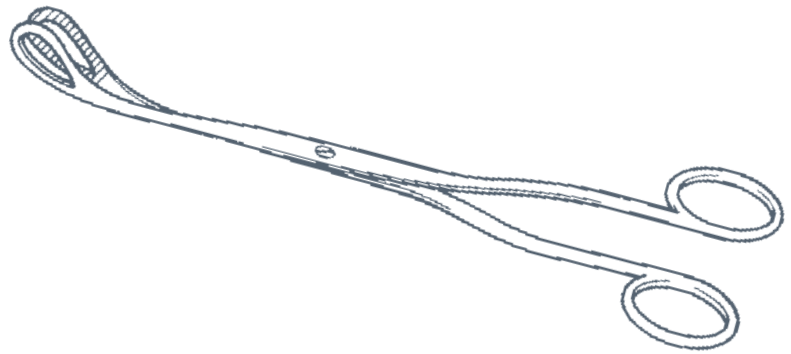

GYN

## PERITONEUM FORCEPS

### Goodwin Amniotomy

double curved  
3265/05 250mm

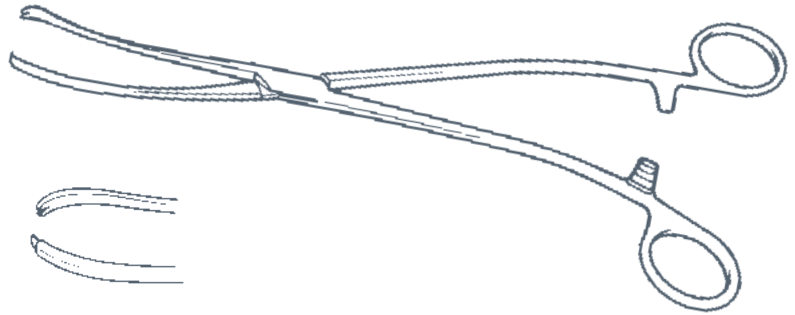

### Green Armytage

straight, screw joint  
3270/05 210mm

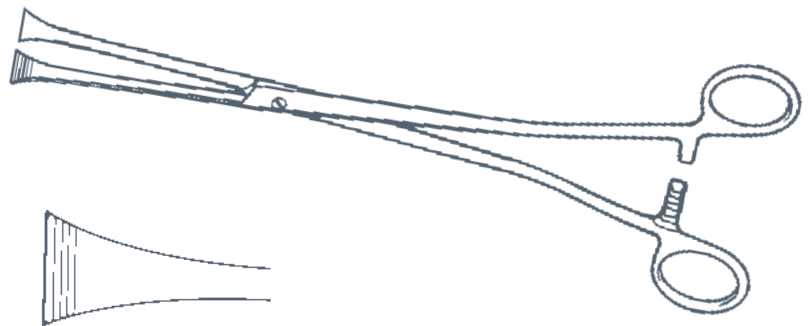

### Green Armytage

angled, screw joint  
3271/05 200mm

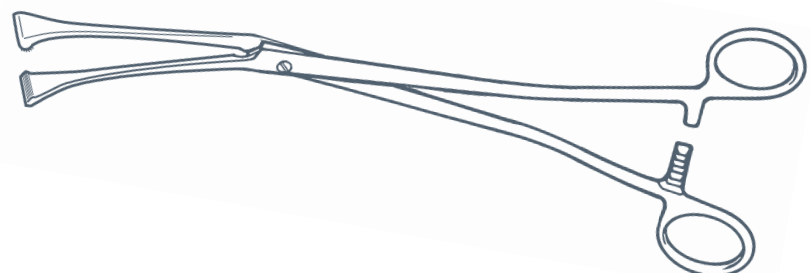



## RETRACTORS

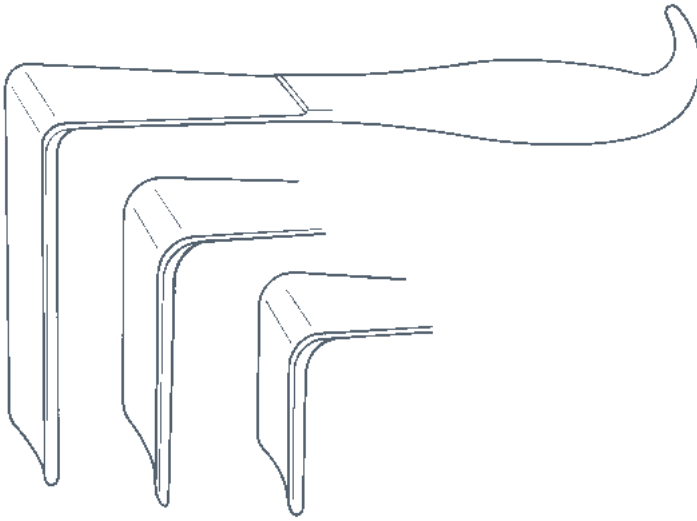

### Doyen (Pozzi)

3295/05 small, 48mm x 60mm

3295/10 medium, 48mm x 90mm

3295/15 large, 48mm x 124mm

GYN

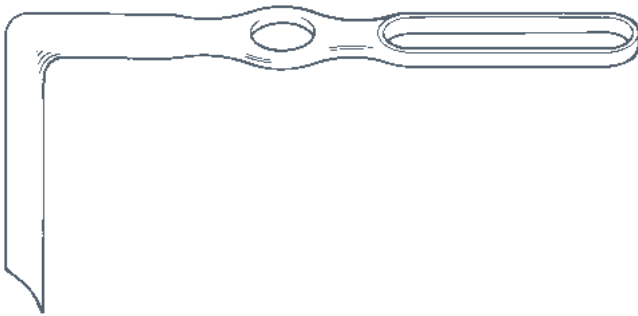

### Landon Vaginal

3305/05 90mm x 25mm blade

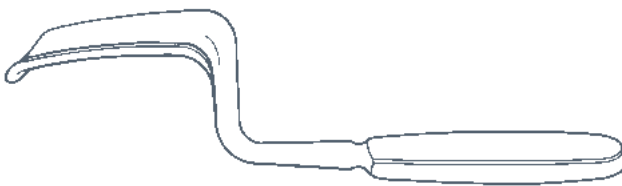

### Wertheim

3310/05 95mm x 38mm blade

## RETRACTORS, SELF-RETAINING

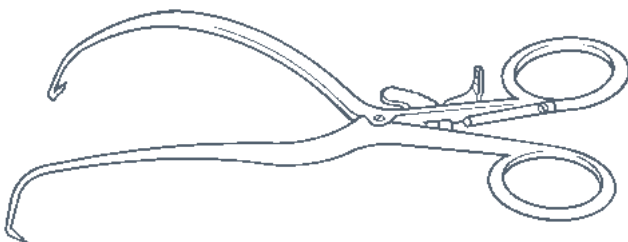

### Gelpi Vulva

3315/05 170mm



## SCISSORS

### Barnes (Lawson Tait)

episiotomy

3320/05 140mm

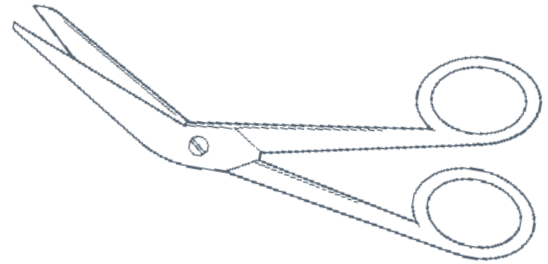

GYN

### Braun-Stadler

episiotomy

3325/05 140mm

3325/10 200mm

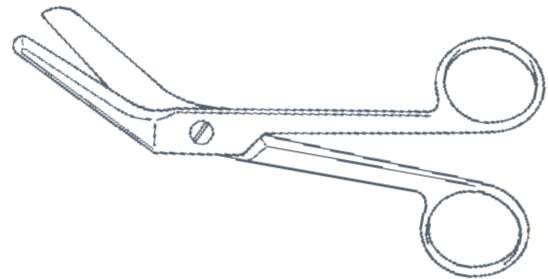

### Chassar Moir

curved, blunt points

3327/25 180mm

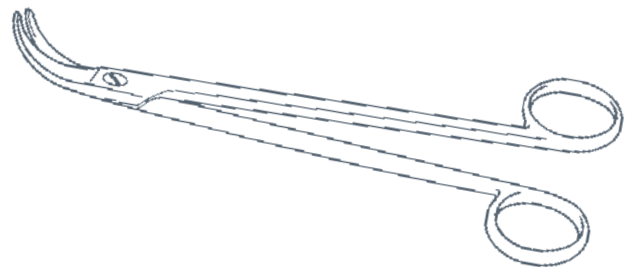

### Chassar Moir

angled on flat, blunt points

3327/50 200mm

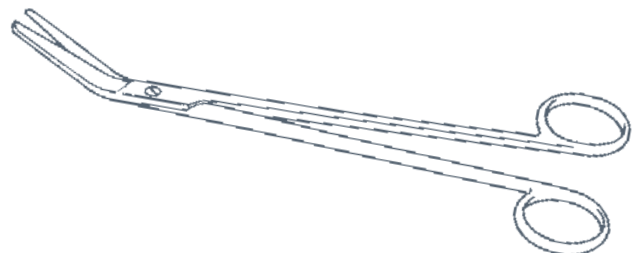



## SCISSORS

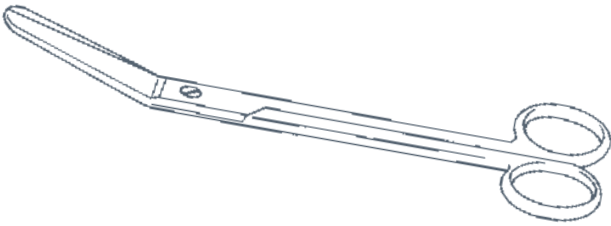

### Currie Uterine

angled on flat  
3329/05 200mm

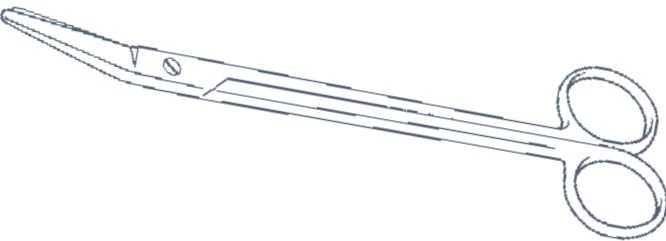

### Monaghan

angled on flat, heavy pattern  
3331/05 220mm

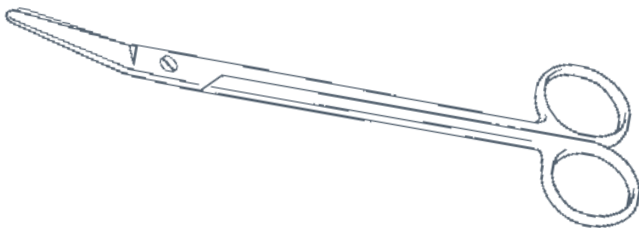

### Monaghan

angled on flat, light pattern  
3332/05 210mm

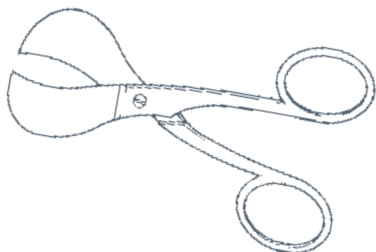

### Umbilical

American Pattern  
3335/05 100mm



## SCISSORS

### Uterine

straight

3340/05 230mm

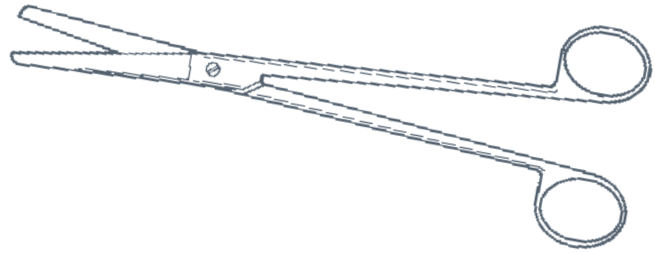

### Uterine

curved

3341/05 230mm

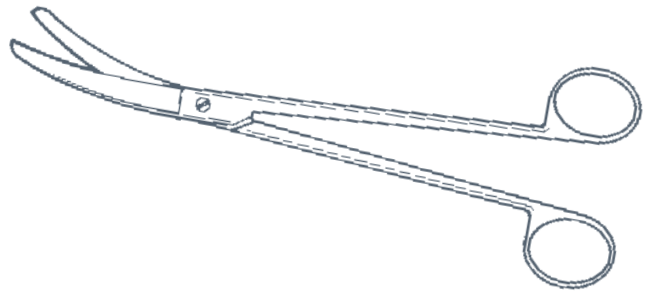

### Uterine

angled

3342/05 230mm

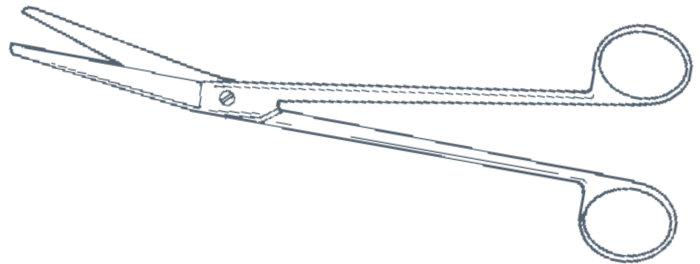

### Vant

episiotomy

3345/05 240mm

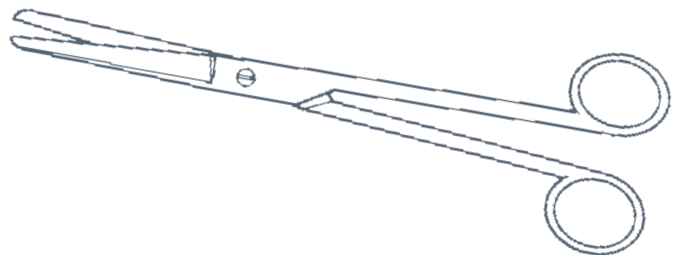





## SOUNDS



### Galabin Uterine

malleable, shaft graduated in cms  
3355/05 290mm



### Horrocks Uterine

malleable, shaft graduated in 2cm intervals  
3360/05 300mm



### Sims Uterine

malleable  
3370/05 320mm

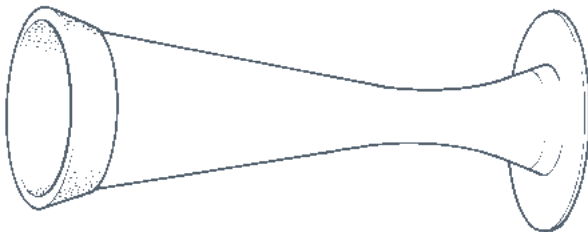

### Pinard Foetal

aluminium  
3380/05 140mm  
plastic  
3381/05 140mm

## STETHOSCOPES



### Gillies

3390/05 175mm

## SUCTION TUBES

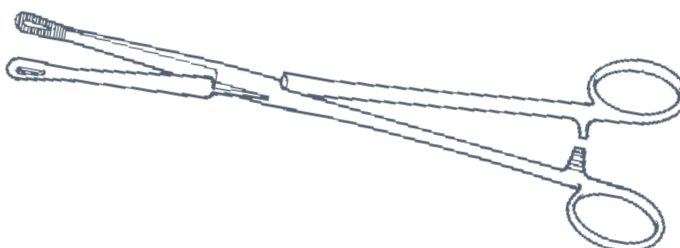

## UTERINE FORCEPS

### Bonney Polypus

oval  
3400/05 240mm



## VAGINAL SPECULA

GYN

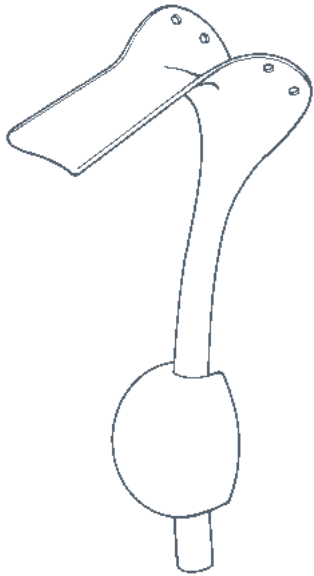

### Auvard

- 3425/05 with detachable weight
- 3426/05 with fixed weight

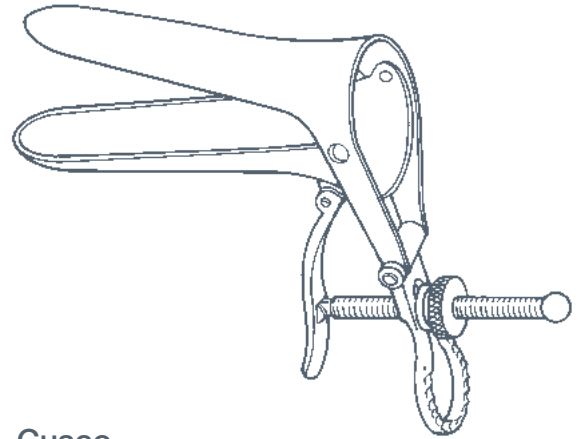

### Cusco

- 3430/05 virgin
- 3430/10 small
- 3430/15 medium
- 3430/20 large

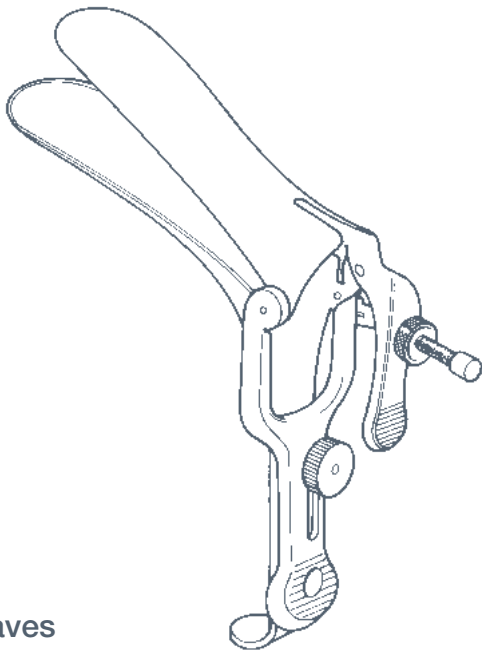

### Graves

- 3435/05 small
- 3435/10 medium
- 3435/15 large

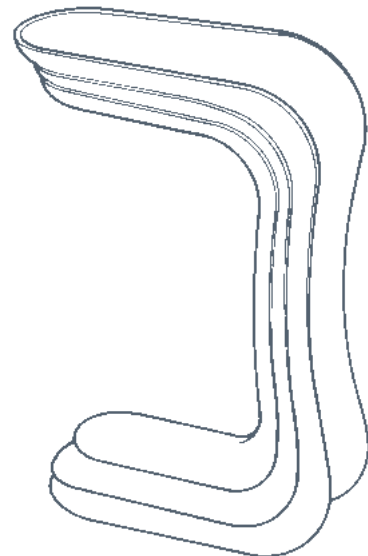

### Sims

- double ended
- 3445/05 small
- 3445/10 medium
- 3445/15 large
- 3445/95 set of 3



## VULSELLUM FORCEPS

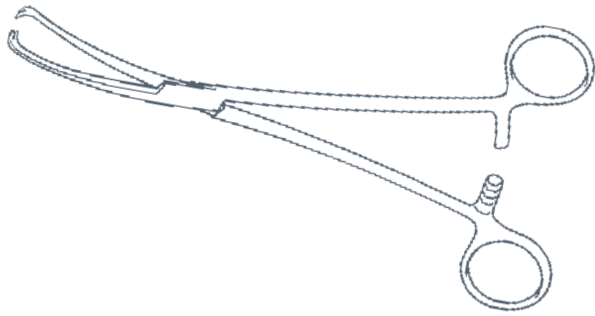

**Lewer**

2/2 teeth  
3455/10 230mm

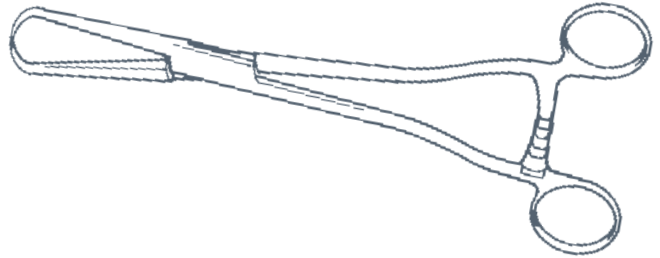

**Luer**

1/1 teeth  
3460/05 230mm

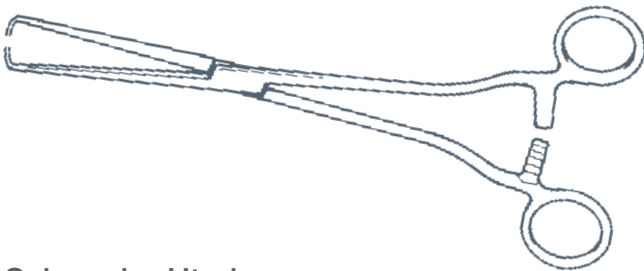

**Schroeder Uterine**

1/1 teeth  
3465/05 225mm

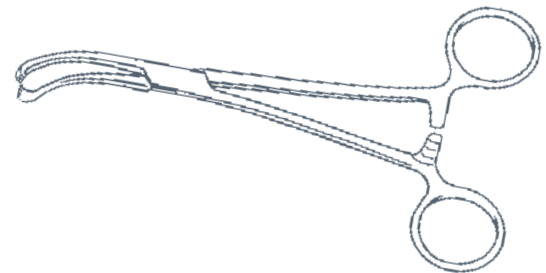

**Teales Uterine**

curved, 3/4 teeth  
3470/05 180mm  
3470/10 230mm



straight, 3/4 teeth  
3471/10 230mm

**GYN**





## BOUGIES

### Clutton Urethral Sounds



tapered, length 265mm

<b>3505/05</b>	6/10 fg	<b>3505/40</b>	20/24 fg
<b>3505/10</b>	8/12 fg	<b>3505/45</b>	22/26 fg
<b>3505/15</b>	10/14 fg	<b>3505/50</b>	24/28 fg
<b>3505/20</b>	12/16 fg	<b>3505/55</b>	26/30 fg
<b>3505/25</b>	14/18 fg	<b>3505/60</b>	28/32 fg
<b>3505/30</b>	16/20 fg	<b>3505/95</b>	set of 12
<b>3505/35</b>	18/22 fg		

## CATHETER INTRODUCERS



### Foley Balloon

curved

**3550/05** 455mm



### Guyon

curved, 430mm

**3560/05** small tip 2mm diameter

**3560/10** large tip 4mm diameter



## CLAMPS

### Thomson-Walker Pedicle

angled, screw joint  
3580/05 200mm

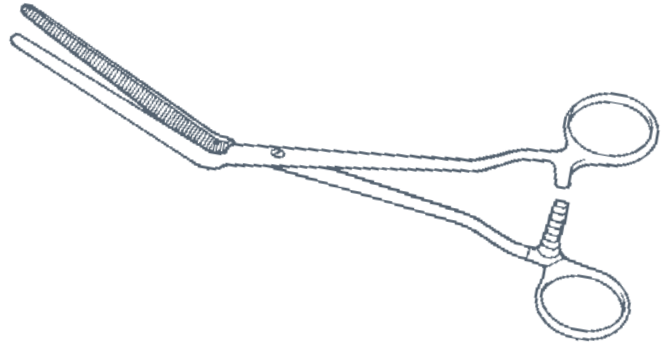

### Thomson-Walker Penile

cross action  
3581/05 115mm

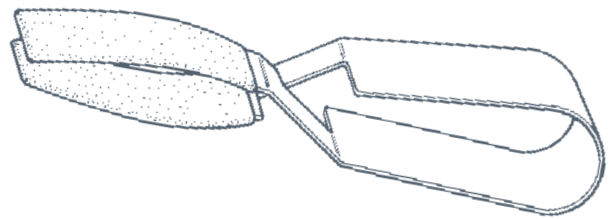

## CLAMPS, ATRAUMATIC

### Herrick Kidney Pedicle

1/2 serrations, double angle  
3590/05 265mm

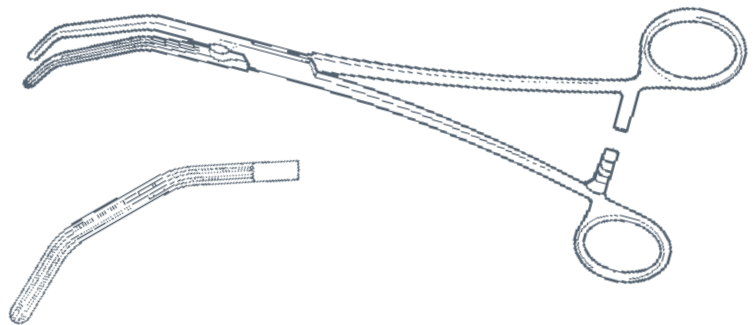

## DISSECTING FORCEPS

### Millins

3/4 teeth  
3610/05 225mm

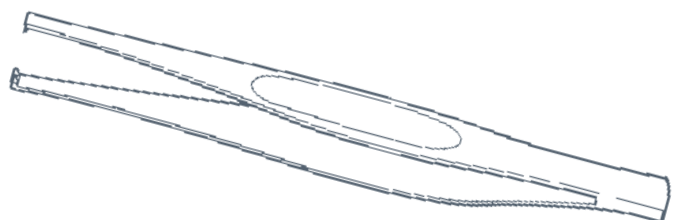



## RETRACTORS



### Millin Bladder

neck spreader, cross action  
3700/25 240mm

## STONE FORCEPS

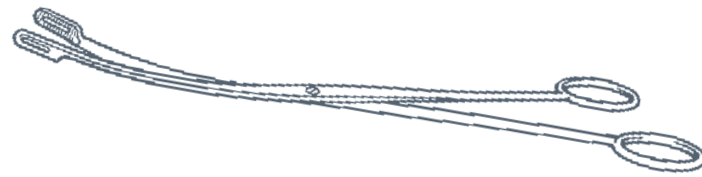

### Randall Renal Calculus

screw joint, fenestrated jaw  
3735/05 shape A, 230mm

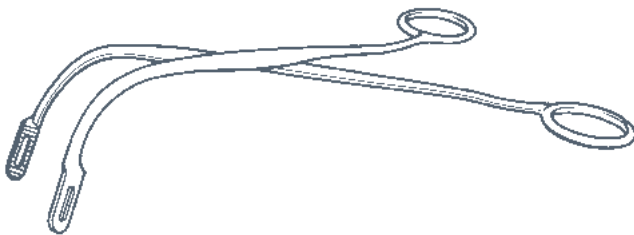

### Randall Renal Calculus

screw joint, fenestrated jaw  
3736/05 shape B, 210mm



### Randall Renal Calculus

screw joint, fenestrated jaw  
3737/05 shape C, 195mm



### Randall Renal Calculus

screw joint, fenestrated jaw  
3738/05 shape D, 180mm



PRO







# BIOPSY FORCEPS



## Yeoman

basket-jawed to use through sigmoidoscope

fig. 2

- 3819/05 250mm effective length
- 3819/10 355mm effective length
- 3819/15 430mm effective length



fig. 3

- 3820/05 250mm effective length
- 3820/10 355mm effective length
- 3820/15 430mm effective length

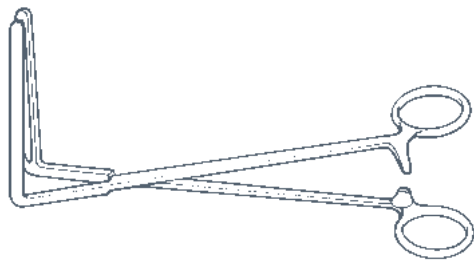

# CLAMPS

PRO

## Finch Rectal Excision

with hollowed jaws

- 3830/05 215mm, 75mm blade

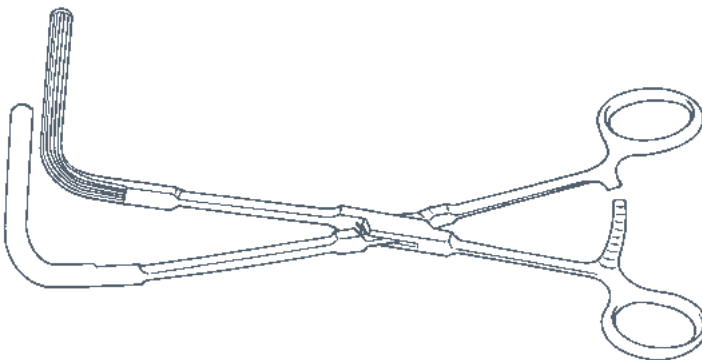

## Lloyd-Davies Rectal Excision

longitudinal serrations

- 3833/05 305mm, 70mm blade

# CLAMPS, ATRAUMATIC

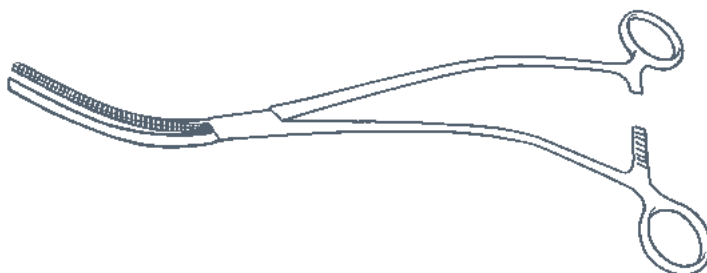

## Einsell Foss Colon Resection

curved

- 3837/05 305mm



## CLAMPS, ATRAUMATIC

### Hayes Colon Resection

jaws angled 70°

3840/05 260mm, 80mm jaws

3840/10 280mm, 100mm jaws

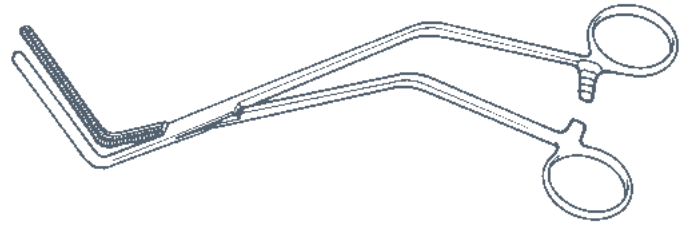

## DILATORS

### St Marks Rectal

plastic

3845/05 small

3845/10 large

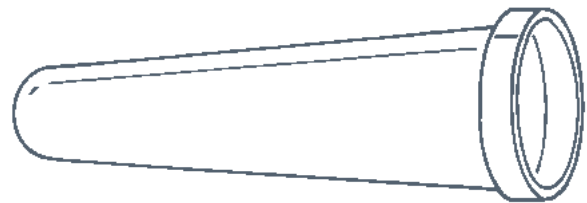

PRO

## DIRECTORS

### Lockhart Mummery Fistula

length 165mm

3850/05 No.1 straight



3850/10 No.2 45° curve



3850/15 No.3 90° curve



3850/20 No.4 Retrograde





## DISSECTING FORCEPS

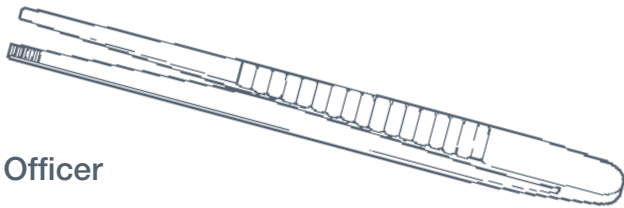

### Officer

serrated

**3855/05** 150mm

**3855/10** 200mm

**3855/15** 250mm

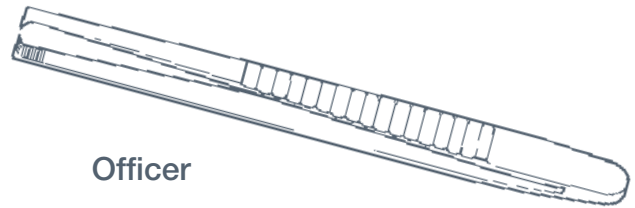

### Officer

2/3 teeth



**3856/05** 150mm

**3856/10** 200mm

4/5 teeth



**3857/05** 150mm

**3857/10** 200mm

**3857/15** 250mm

## HAEMORRHOID LIGATOR SET

PRO

### Barron

comprising ligator, conical loader,  
300 'O' rings and handle

**3860/25** 215mm, complete

**3860/50** spare conical loader

**3860/55** spare rings, pack of 300

**3860/60** spare handle

**3860/65** spare stem

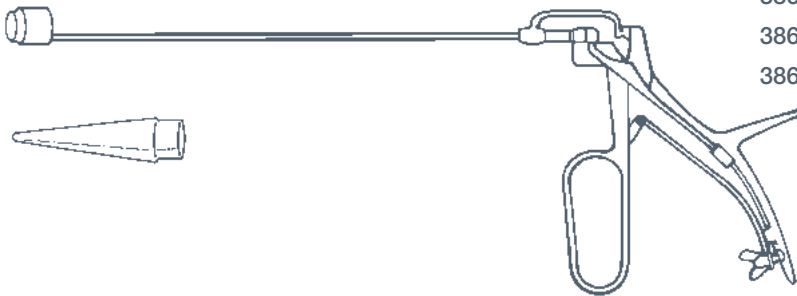

### McGivney

comprising ligator, conical loader,  
300 'O' rings and handle

**3861/25** complete

**3861/50** spare conical loader

**3861/55** spare ligator

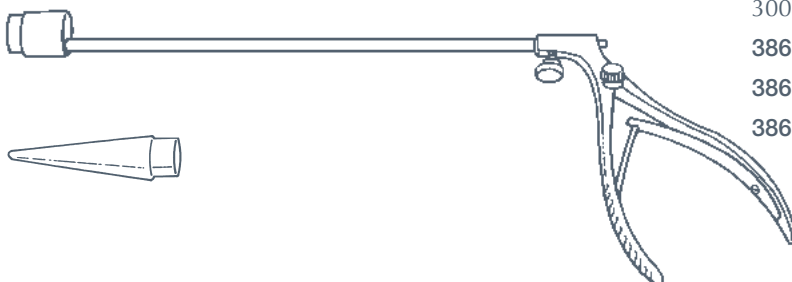



## HAEMORRHOID SEIZING FORCEPS

### St George's Pattern

3/4 teeth

3863/05 190mm

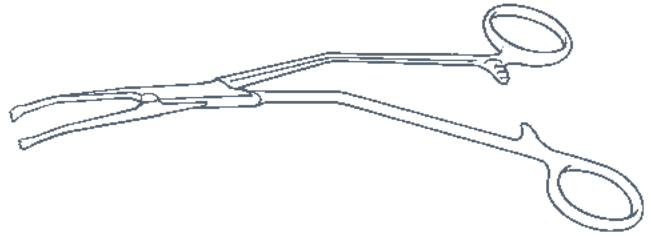

## PROCTOSCOPES

### Kelly

with obturator

3865/05 22mm x 50mm

3865/10 22mm x 100mm

3865/15 22mm x 140mm

3865/20 22mm x 200mm

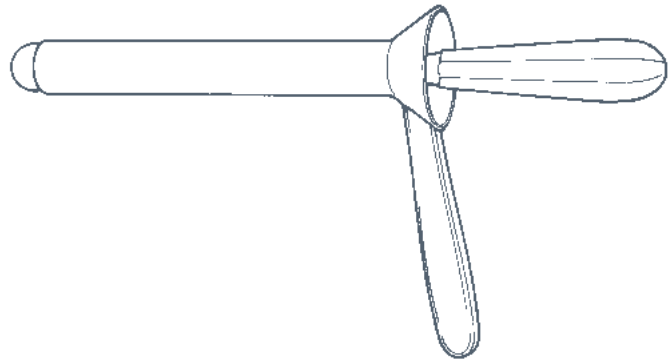

PRO

## RECTAL SPECULA

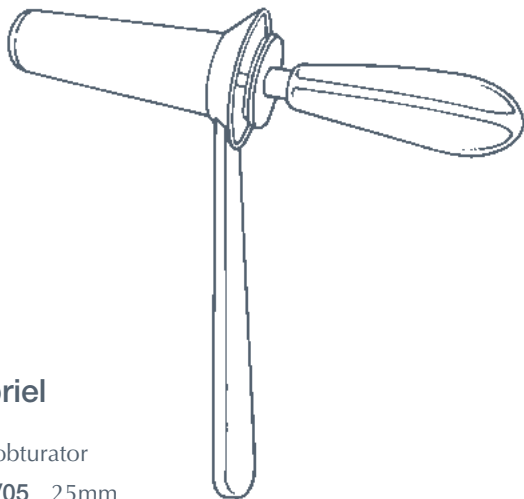

### Gabriel

with obturator

3869/05 25mm

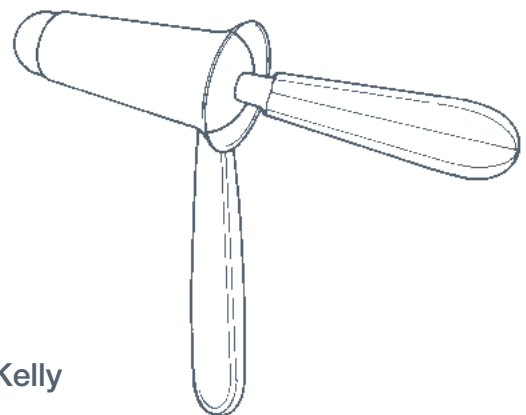

### Kelly

with obturator

3873/05 21mm diameter

3873/10 27mm diameter

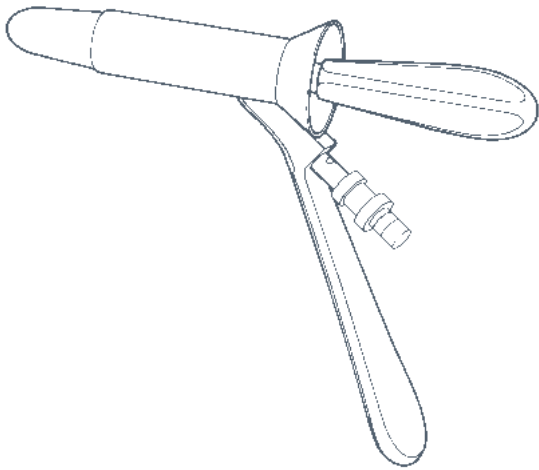

## RECTAL SPECULA

### Naunton Morgan

with obturator

**3875/05** 17mm diameter

**3875/10** 20mm diameter

**3875/15** 24mm diameter

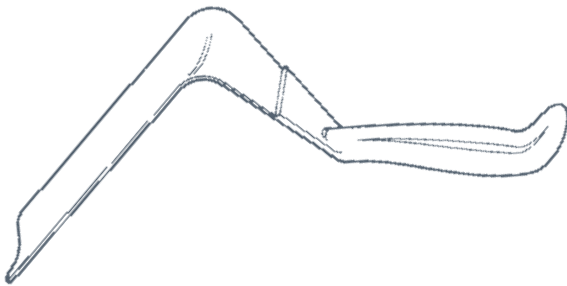

## RETRACTORS

### Lloyd-Davies

short, without tapered end

**3895/05** 125mm x 55mm

long, with tapered end

**3895/10** 170mm x 65mm x 50mm

PRO

## RETRACTORS, SELF-RETAINING

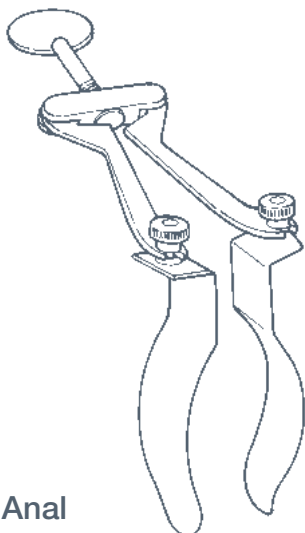

### Park Anal

adult

**3900/05** 130mm, 95mm blades

child

**3900/25** 130mm, 70mm blades

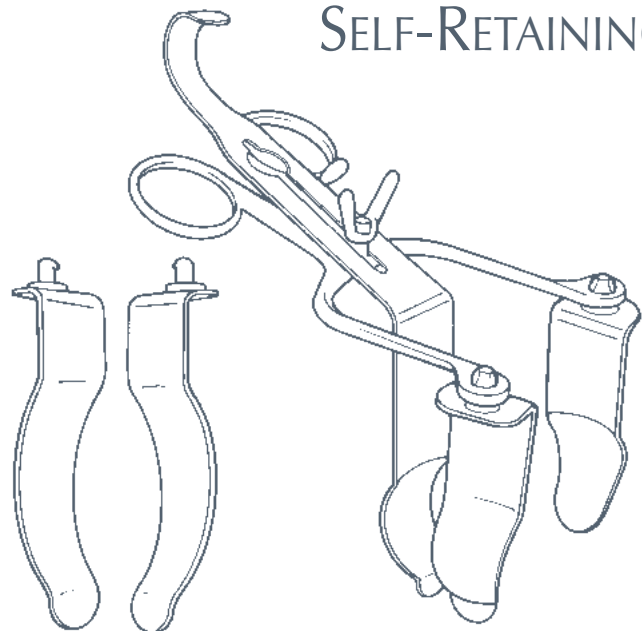

### Park Combined

with 2 sets of interchangeable blades and  
one adjustable centre blade, 140mm

**3905/05** complete



## SCISSORS

### Abel Abdominal-Perineal

straight  
3915/05 320mm

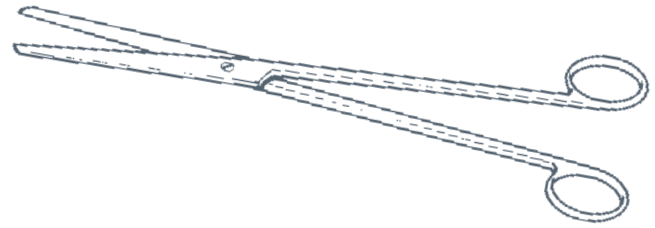

### Goligher

straight  
3920/05 300mm

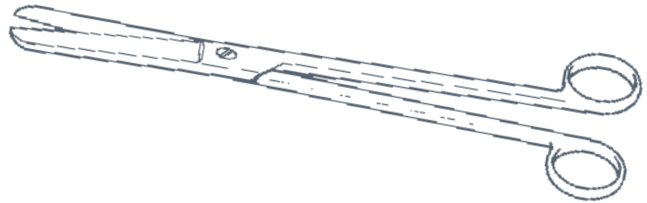

### Goligher

curved  
3921/05 300mm

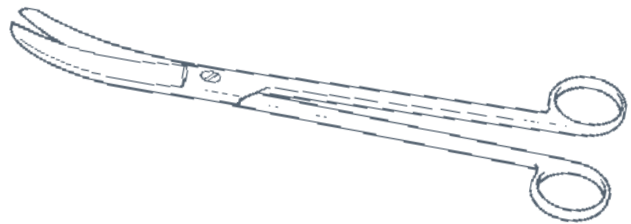

PRO

### Lloyd-Davies Rectal

straight, flattened blades, blunt points  
3925/05 265mm

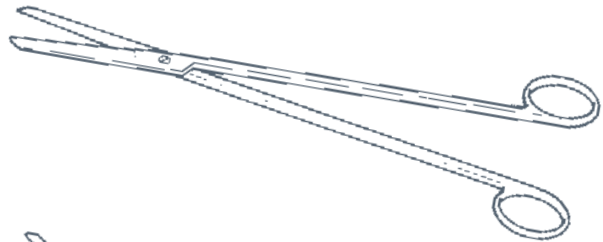

### Lloyd-Davies Rectal

curved on flat, flattened blades, blunt points  
3926/05 265mm

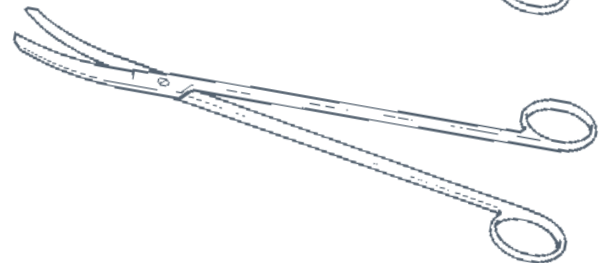

### Parks' Lower Colonic

angled on side, blunt/blunt  
3928/25 170mm, blades curved to right

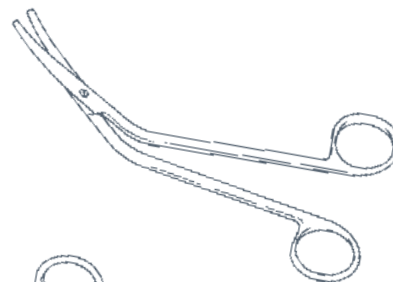

### Parks' Lower Colonic

angled on side, blunt/blunt  
3928/50 170mm, blades curved to left

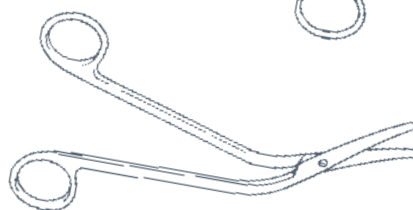



## SIGMOIDOSCOPES

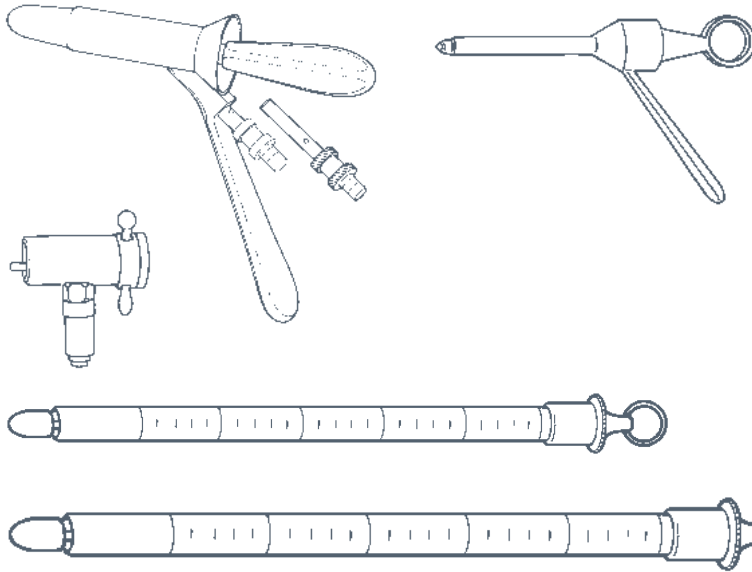

### Lloyd-Davies

major set, comprising adult sigmoidoscope with obturator, 300mm x 20mm, adolescent sigmoidoscope with obturator 250mm x 15mm, child proctoscope with obturator 10mm diameter, Naunton Morgan rectal speculum with obturator 20mm diameter with fibre light carriers and fibre optic illumination head unit  
**3935/50** complete in case

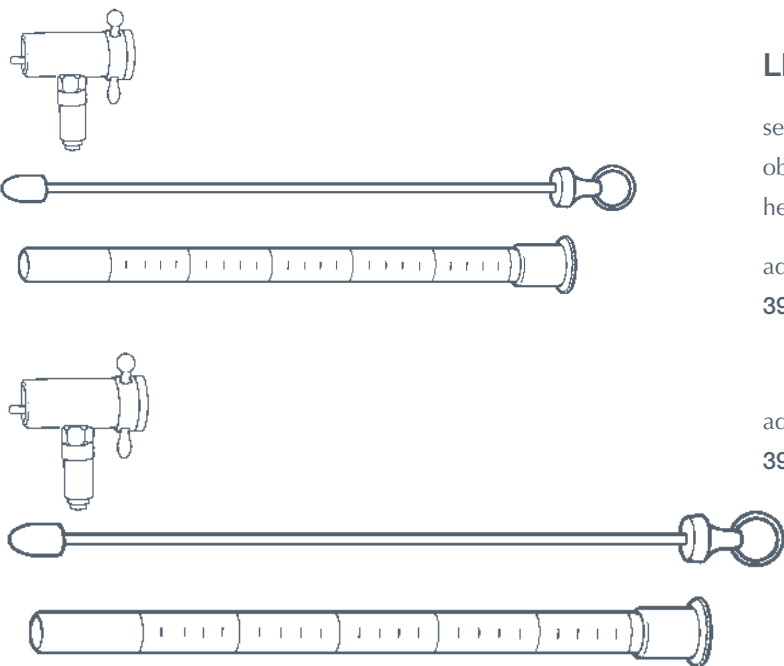

### Lloyd-Davies

set comprising 1 graduated tube with obturator, with fibre optic illumination head unit, complete in case

adolescent

**3937/05** tube 250mm x 15mm

adult

**3937/25** tube 300mm x 20mm

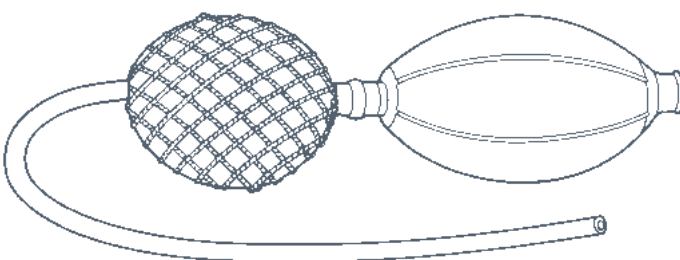

### Inflation Bellows

**3950/05** rubber, double

PRO







## CHISELS OSSEUS



**Coupland**

4001/01 fig 1



**Coupland**

4001/02 fig 2



**Coupland**

4001/03 fig 3

## ELEVATORS



**Periosteal**

4002/01 fig 1



**Periosteal**

4002/02 fig 9

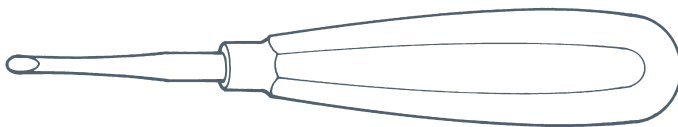

**Apical**

straight

4010/01 fig 26



left

4010/02 fig 27



right

4010/03 fig 28





## ELEVATORS

### Apical

4010/04 fig 34CD



4010/05 fig 34SCD



4010/06 fig 44CD



4010/07 fig 46CD



4010/08 fig 81CD



### Coleman

serrated

4010/09 fig 20

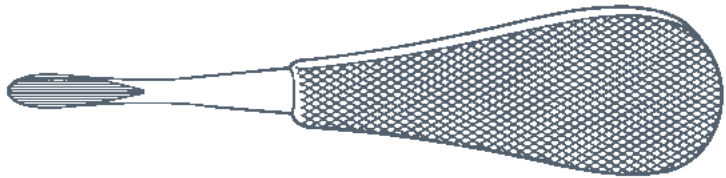

### Hospital

left

4010/12 fig21

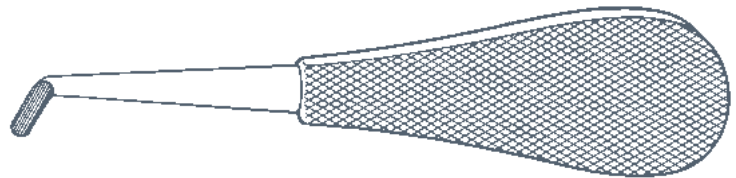

right

4010/13 fig22





## ELEVATORS

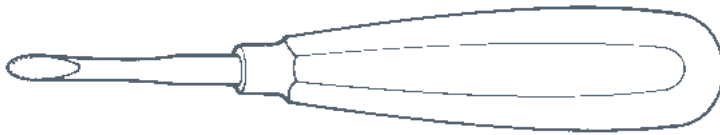

### Lindo Levien

large  
4010/14 fig LLL



medium  
4010/15 fig LLM



small  
4010/16 fig LLS

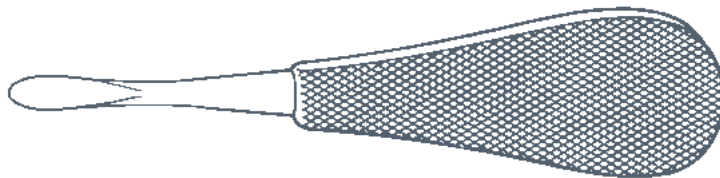

### Reads

smooth  
4010/17 fig 19



### Warwick James

4010/18 straight



4010/19 right



4010/20 left





## ELEVATORS

### Winters Root

4010/21 fig 1L



4010/22 fig 1R



4010/23 fig 12L



4010/24 fig 12R

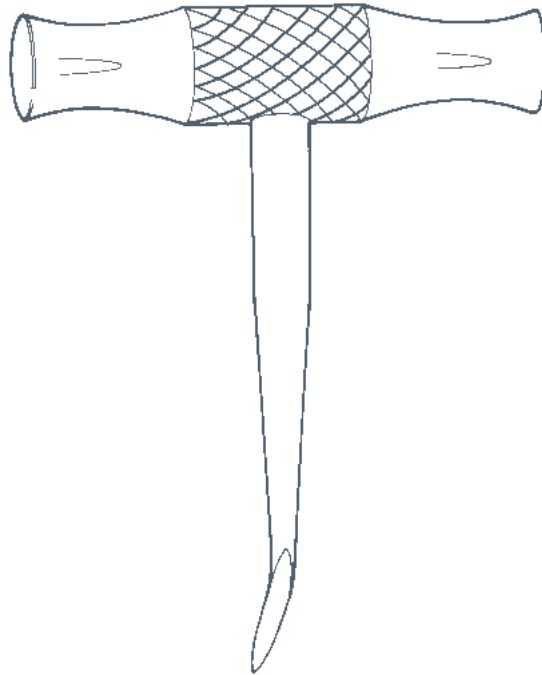

## EXOLEVERS

### Apical

straight fig 78CD  
4020/00

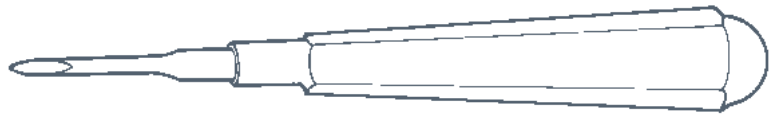

left fig 79CD  
4020/01



right fig 80CD  
4020/02

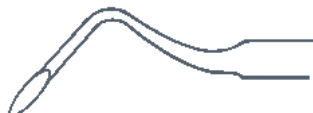

### Apical Clinic

straight fig 81  
4020/03

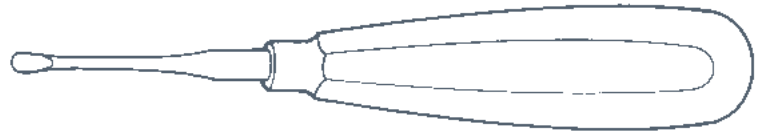

left fig 81  
4020/04



right fig 81  
4020/05

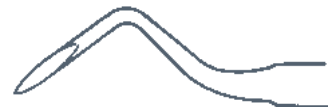



## EXOLEVERS

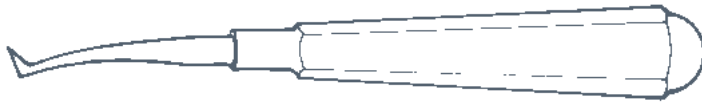

### Cryers

left fig 30  
4020/06



right fig 31  
4020/07



## EXTRACTING FORCEPS



### Upper Anteriors

4030/01 fig 1



4030/02 fig 2



4030/03 fig 29



4030/04 fig 29S



4030/05 fig 107



4030/06 fig 113 (Martin)



4030/07 fig 165



4030/09 fig 136H (Guys)





## EXTRACTING FORCEPS

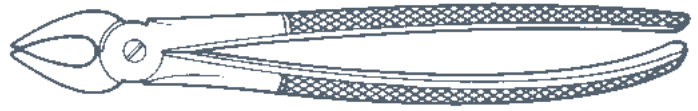

### Upper Premolars and Roots

4031/01 fig 7



4031/02 fig 30

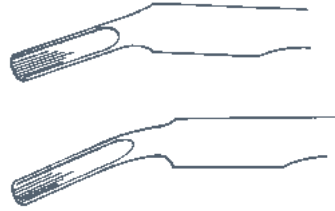

4031/07 fig 136 (Guys)



DENT

4031/03 fig 41

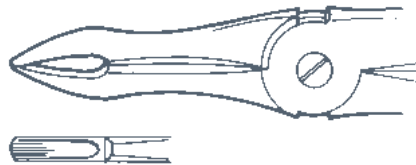

4031/08 fig 44N

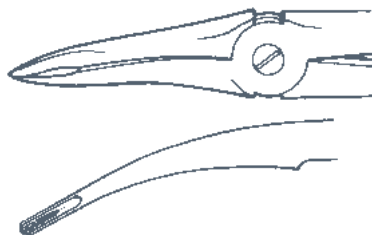

4031/04 fig 44S

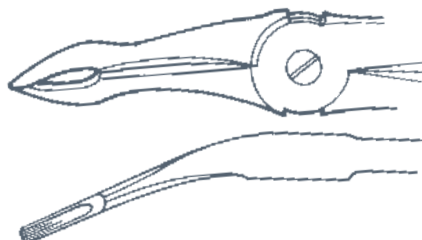



## EXTRACTING FORCEPS

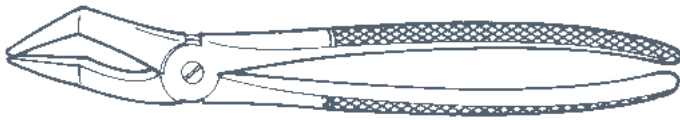

### Upper Roots



4032/00 fig 51



4032/01 fig 52



4032/11 fig 147 (Gibb)

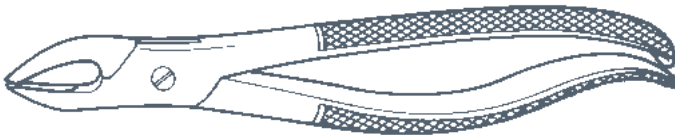

4032/02 fig 76



4032/03 fig 76H



4032/04 fig 76N



4032/05 fig 76S

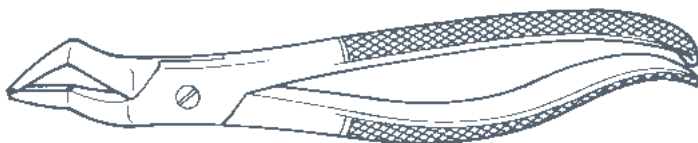

4032/09 fig 104 (Robin)



4032/07 fig 101



4032/08 fig 101A



## EXTRACTING FORCEPS

### Upper Roots

4032/15 fig 108 (Hill)

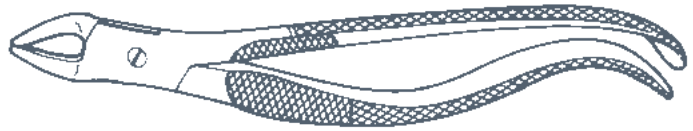

4032/10 fig 110 (Thorne)

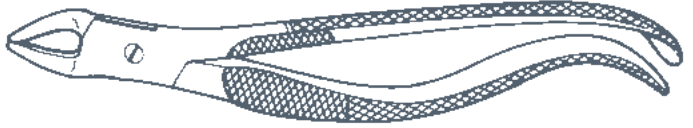

4032/12 fig 112 (Martin)

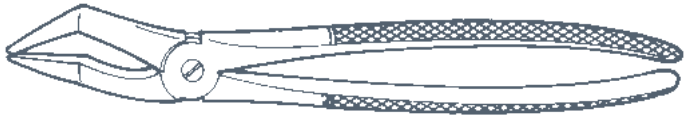

4032/16 fig 139



### Upper Molars

4033/01 fig 17



4033/02 fig 18







## EXTRACTING FORCEPS

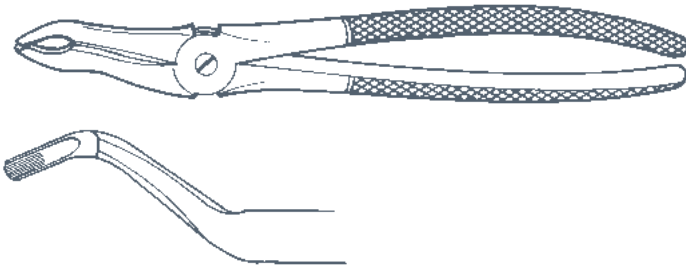

Upper Molars

4033/03 fig 88

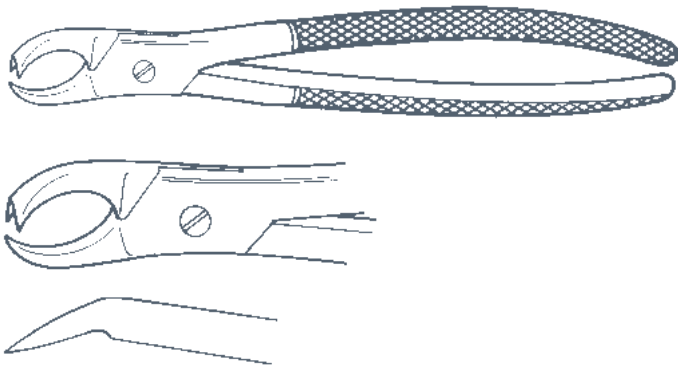

4033/04 fig 89

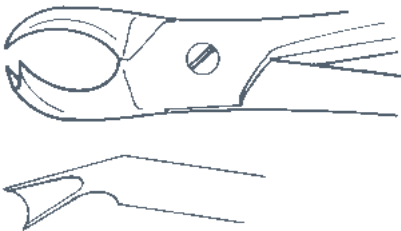

4033/05 fig 90

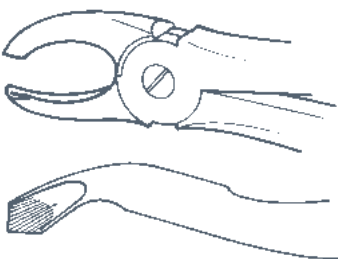

4033/06 fig 92

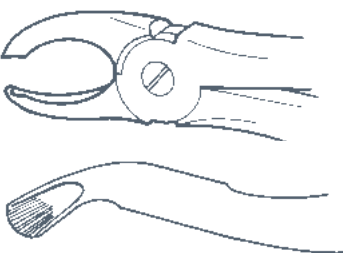

4033/07 fig 93



## EXTRACTING FORCEPS

### Upper Molars

4033/08 fig 94

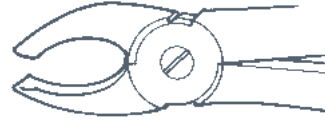

4033/09 fig 95



4033/10 fig 96



4033/11 fig 97



### Upper Wisdom and Roots

4034/01 fig 19



4034/02 fig 67

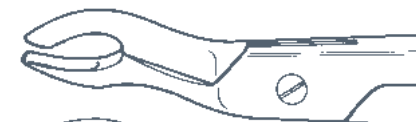



## EXTRACTING FORCEPS

### Lower Centrals and Roots

4035/02 fig 143 (Coleman)

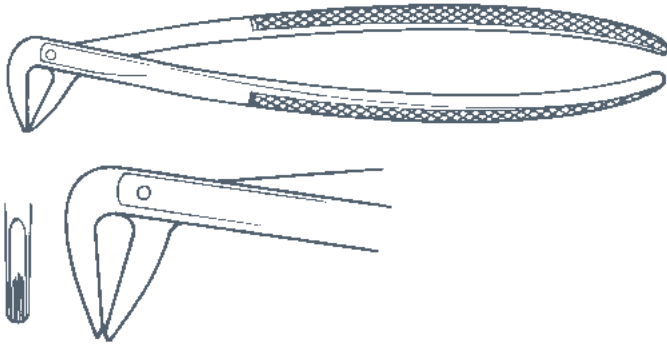

### Lower Incisors, Canines and Premolars

4036/05 fig 4

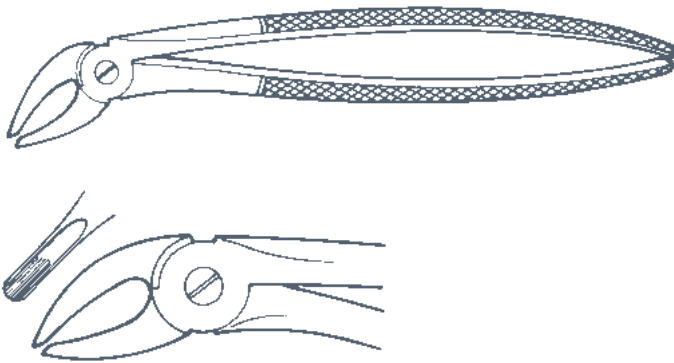

4036/02 fig 13



4036/03 fig 75

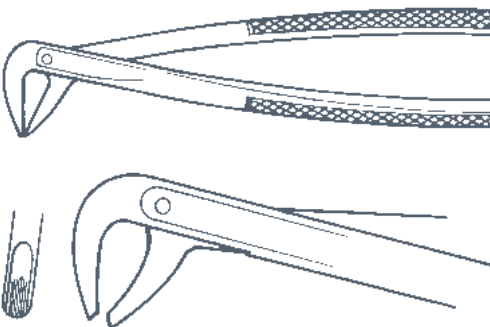

4036/04 fig 75A

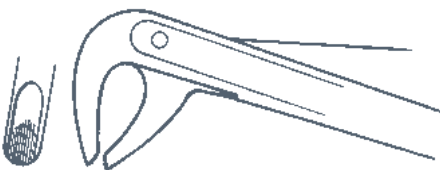



## EXTRACTING FORCEPS



Lower Molars

4037/02 fig 22

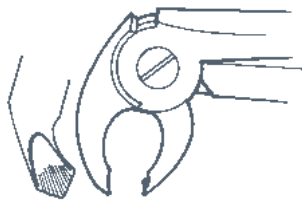

4037/04 fig 24

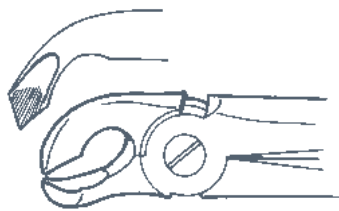

4037/06 fig 32

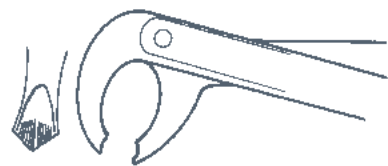

4037/09 fig 73

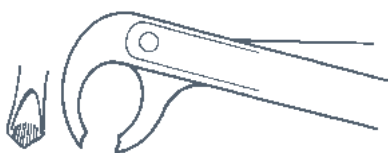

4037/11 fig 73S

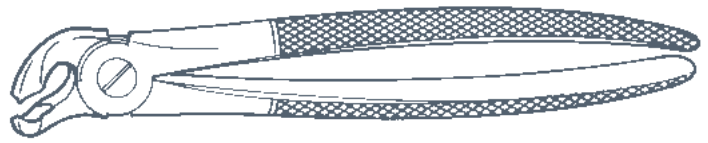

4037/03 fig 23

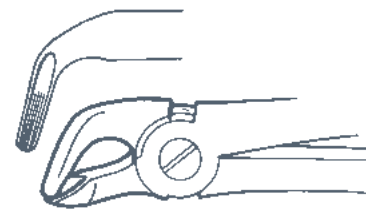

4037/05 fig 31



4037/07 fig 33

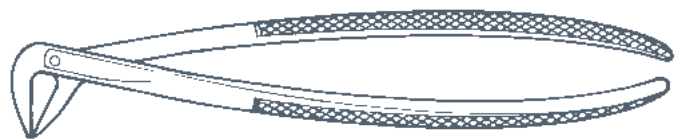

4037/10 fig 73L



4037/12 fig 99 (Wood)

DENT



## EXTRACTING FORCEPS

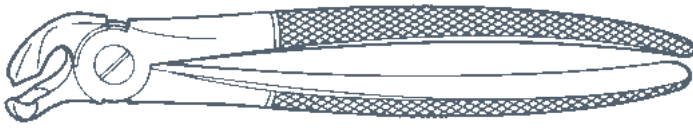

Lower Wisdoms and Molars

4038/01 fig 20

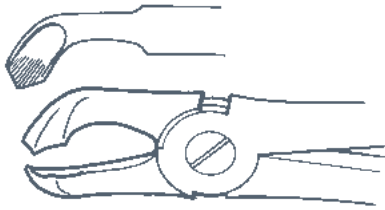
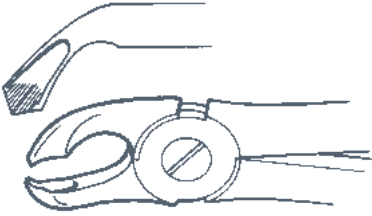

4038/02 fig 79

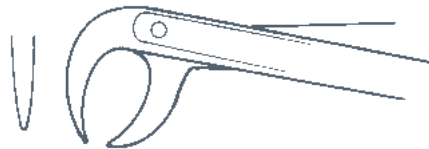
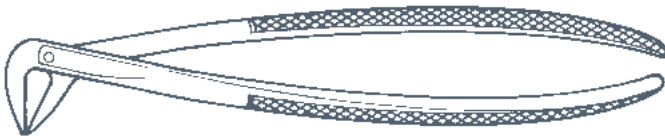

4038/03 fig 86

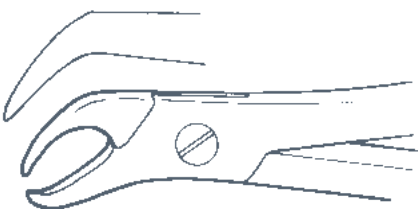
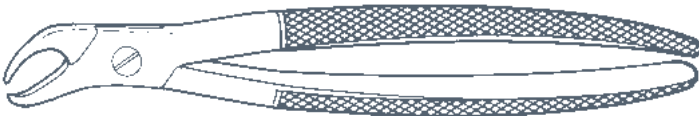

4038/04 fig 87



## EXTRACTING FORCEPS

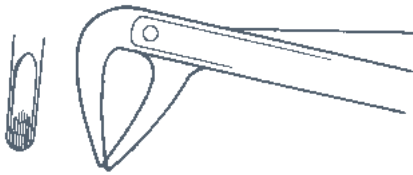

Lower Molars and Roots

4039/01 fig 74

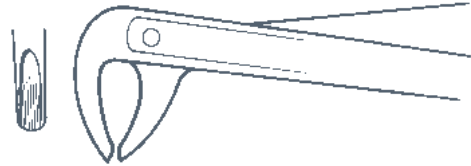

4039/02 fig 74D (Donagan)

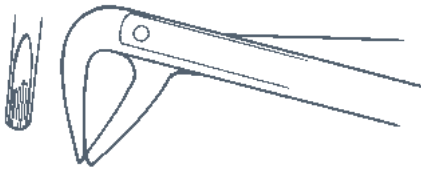

4039/03 fig 74M

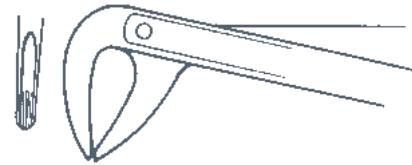

4039/04 fig 74N

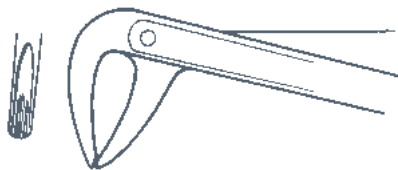

4039/06 fig 114 (Martin)

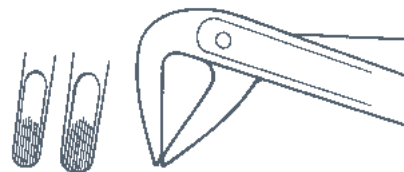

4039/08 fig 137 (Guys)

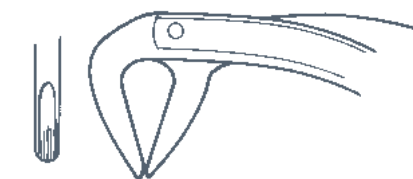

4039/10 fig 144 (Balding)



## EXTRACTING FORCEPS

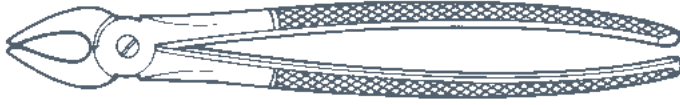

### Children's Patterns



4040/01 fig 37

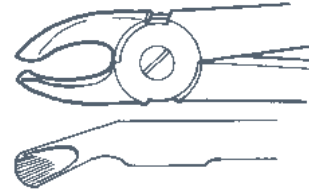

4040/02 fig 39

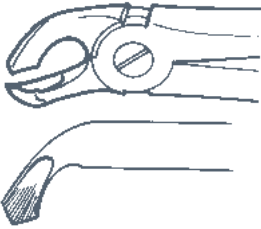

4040/07 fig 40

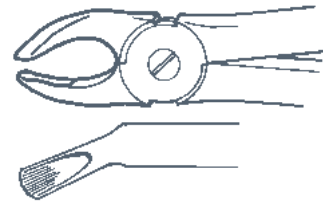

4040/09 fig 157

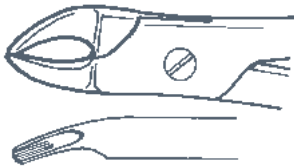

4040/08 fig 138



4040/11 fig 158

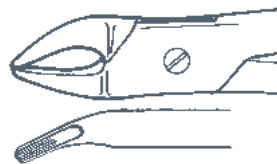

4040/12 fig 159

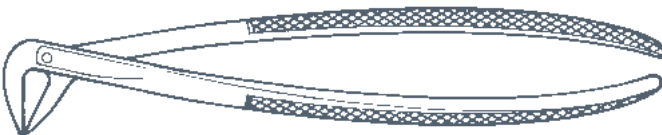

4040/03 fig 123

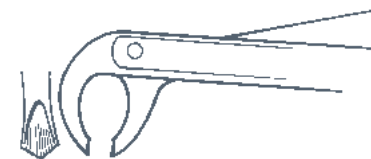

4040/04 fig 160



## EXTRACTING FORCEPS

### Children's Patterns

4040/05 fig 162

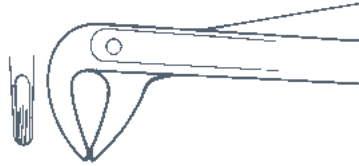
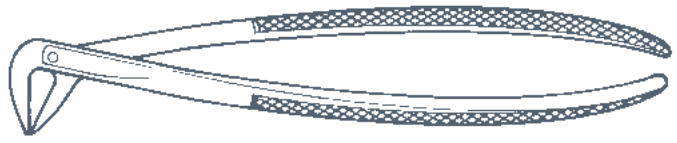

4040/14 fig 161

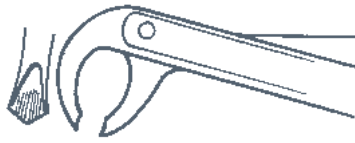

4040/06 fig 163



### Rongeurs

4043/01 fig 3

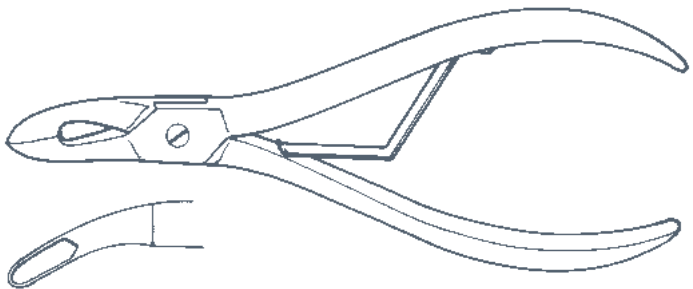

4043/02 fig 4

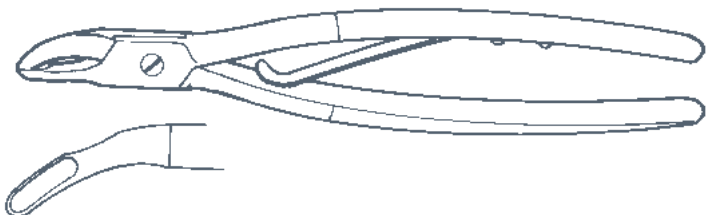





## HAND INSTRUMENTS

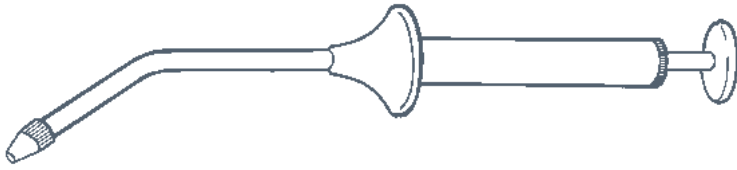

**Amalgam Carrier**

stainless steel  
4047/01 fig 5X

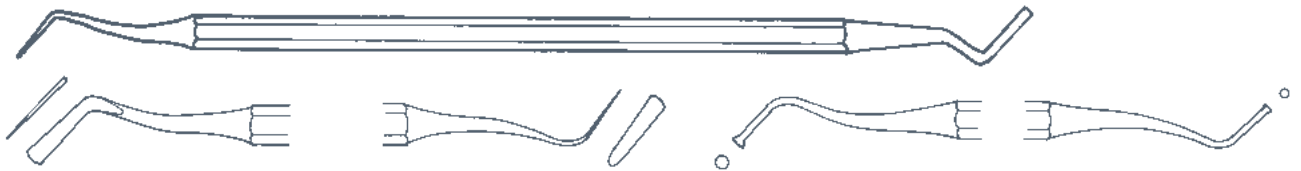

**Condenser**

wards, double ended  
4049/01 fig 1

**Amalgam**

double ended  
4048/01 fig G

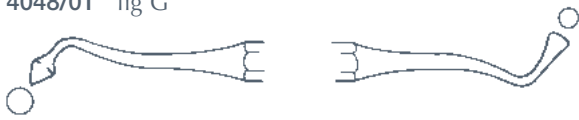

double ended  
4048/02 fig H

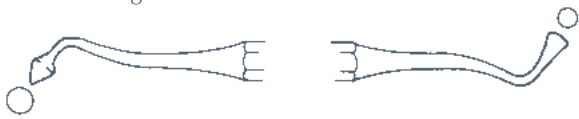

double ended  
4048/03 fig J



double ended  
4048/04 fig O



double ended  
4048/05 fig P



double ended  
4048/06 fig Q



double ended  
4048/07 fig R

wards, double ended  
4049/02 fig 2



**Plugger**

double ended  
4050/01 fig 0/1  
4050/02 fig 1/2

**Burnisher**

double ended, American pattern  
4051/01 fig 1

double ended, American pattern  
4051/02 fig 1L



## HAND INSTRUMENTS

### Carver

double ended  
4052/01 fig AF34

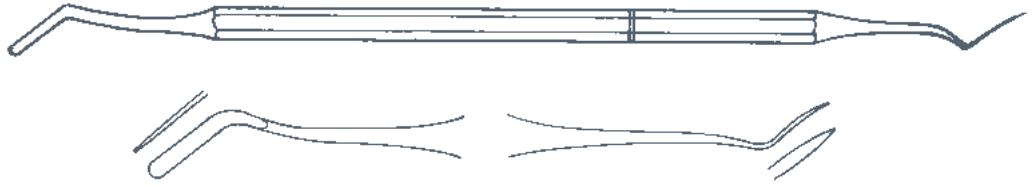

### Carver

double ended  
4052/02 fig 5T

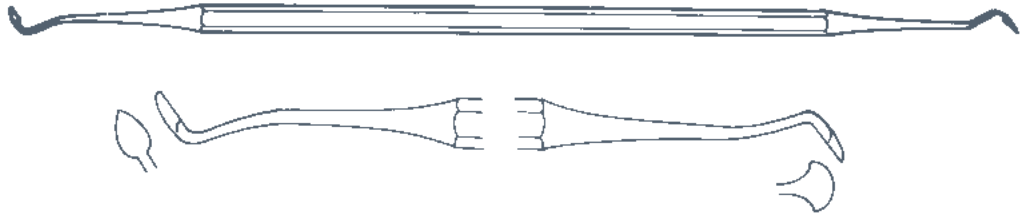

### Clappison

4052/03 fig 4



### Frahm

4052/04 fig 90° R and L

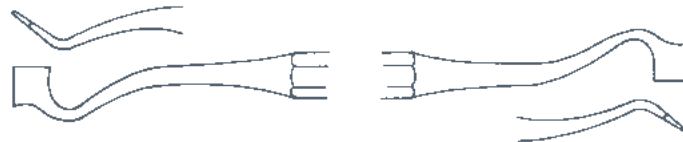

### Hollenbach

4052/05 fig 3  
4052/06 fig 3½



### Hollenbach

4052/07 fig 5



### Carver

Le Cron  
4052/08 double ended



### Osteo Mitchell

4052/09 fig 4

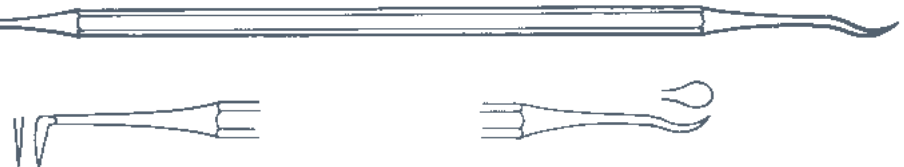

### Wards

4052/10 fig 1





## HAND INSTRUMENTS

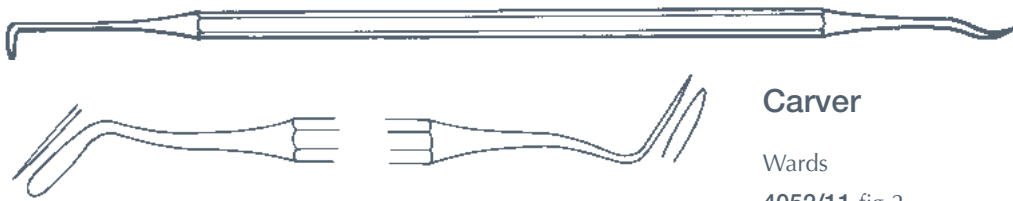

### Carver

Wards  
4052/11 fig 2



Wax carver and spatula  
4052/13 fig 5



### Blacks



hoe, single end  
4053/03 fig 28



hoe, single end  
4053/04 fig 29



hoe, single end  
4053/05 fig 34



hoe, single end  
4053/06 fig 35



enamel hatchet, single end  
4054/01 fig 49



4054/02 fig 50



enamel hatchet, single end  
4054/03 fig 51



4054/04 fig 52



enamel hatchet, single end  
4054/05 fig 53



4054/06 fig 54

bin angle chisel, single end  
4055/01 fig 81



bin angle chisel, single end  
4055/02 fig 82



bin angle chisel, single end  
4055/03 fig 82R



bin angle chisel, single end  
4055/04 fig 83



straight chisel, single end  
4056/01 fig 84



4056/02 fig 85



4056/03 fig 86



side hatchet, single end  
4057/01 fig 88





## HAND INSTRUMENTS

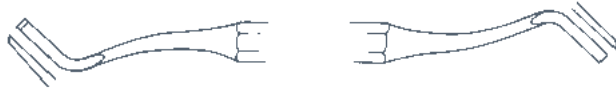

### Blacks

enamel hatchet, double ended

4058/01 fig 51/52



enamel hatchet, double ended

4058/02 fig 53/54



gingival margin trimmer, double ended

4059/01 fig 77/78



gingival margin trimmer, double ended

4059/02 fig 79/80

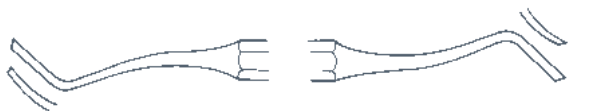

gingival margin trimmer, double ended

4059/03 fig U1/U2



gingival margin trimmer, double ended

4059/04 fig U3/U4



gingival margin trimmer, double ended, tungsten carbide

4060/01 fig TC77/78



gingival margin trimmer, double ended, tungsten carbide

4060/02 fig TC79/80

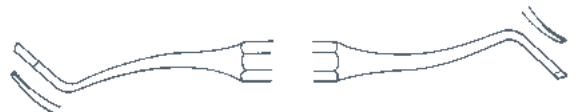

gingival margin trimmer, double ended, tungsten carbide

4060/03 fig TCU1/U2

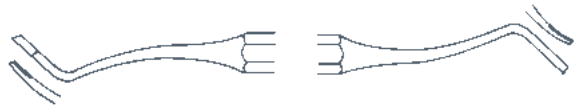

gingival margin trimmer, double ended, tungsten carbide

4060/04 fig TCU3/U4



### Excavator



4065/01 fig 73/74

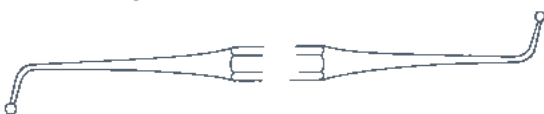

4065/02 fig 119/20

4065/03 fig 121/22

4065/04 fig 123/24



4065/05 fig 125/26



4065/06 fig 127/28



4065/07 fig 129/30



## HAND INSTRUMENTS



### Excavator



4065/08 fig 131/32



4065/09 fig 133/34



4065/10 fig 153/54

4065/11 fig 155/56

4065/12 fig 157/58



4065/13 fig 243



4065/14 fig 244



4065/15 fig 245



4065/16 fig 246



4065/17 fig 204/5



4065/18 fig 210/11



4065/19 fig 220/21



4065/20 fig G2

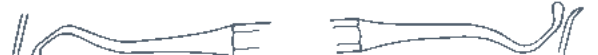

4065/21 fig G4



### Plastics

4067/01 fig 1



4067/02 fig 1A



4067/03 fig 1S



4067/04 fig 2



4067/05 fig 3



4067/06 fig 4



4067/07 fig 5



4067/08 fig 6



## HAND INSTRUMENTS



### Plastics

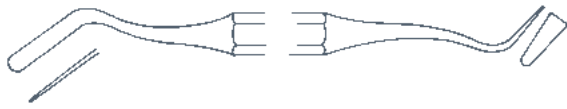

4067/09 fig 6SH

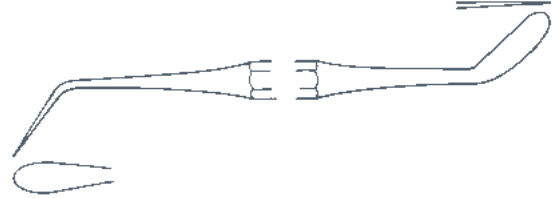

4067/17 fig 22 (Wallis)

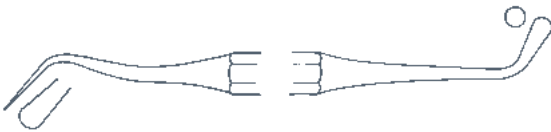

4067/10 fig 7

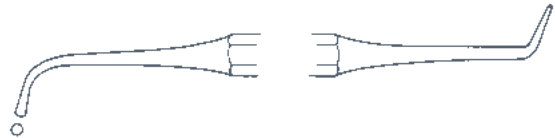

4067/18 fig 49 (Baldwin)



4067/11 fig 11 (Ladmore)

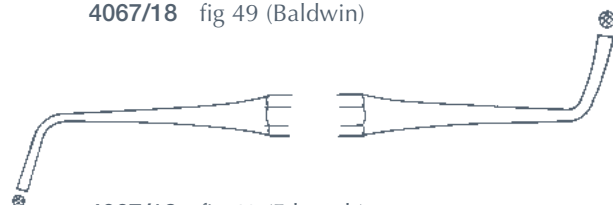

4067/19 fig 62 (Edwards)

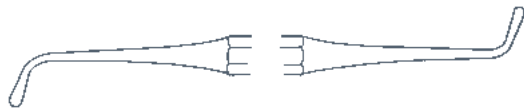

4067/12 fig 12 (Ladmore)



4067/20 fig 63 (Edwards)

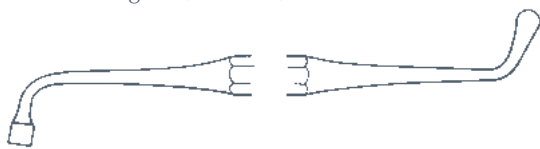

4067/13 fig 16 (Ladmore)

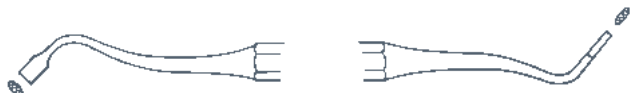

4067/21 fig 151

4067/22 fig 151SM



4067/14 fig 18 (Wallis)



4067/23 fig 153

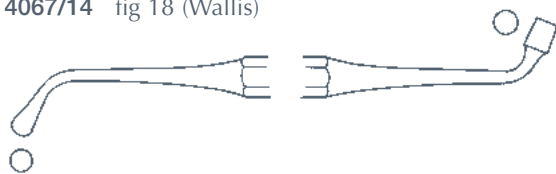

4067/15 fig 20 (Wallis)



4067/24 fig 153A

4067/25 fig 153SM

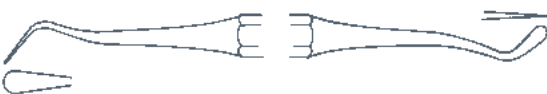

4067/16 fig 21 (Wallis)

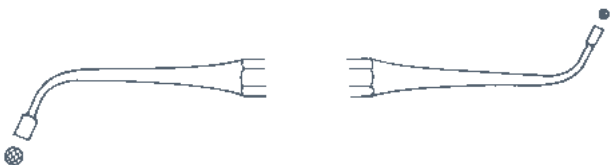

4067/26 fig 154

4067/27 fig 154S



## HAND INSTRUMENTS



### Plastics



4067/28 fig 155 (Hopson)



4067/36 fig 183



4067/29 fig 156 (Hopson)



4067/37 fig 185



4067/30 fig 166



4067/38 fig 187



4067/31 fig 178



4067/39 fig 190



4067/32 fig 179



4067/40 fig PF10



4067/33 fig 180



4067/43 fig G (Guys)



4067/34 fig 181

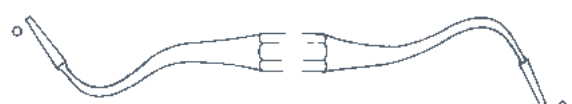

4067/44 fig MOR2 (Mortonson)



4067/35 fig 182

DENT



## HAND INSTRUMENTS

### Probe

4068/01 fig 1



4068/02 fig 2



4068/03 fig 5AM (Explorer)

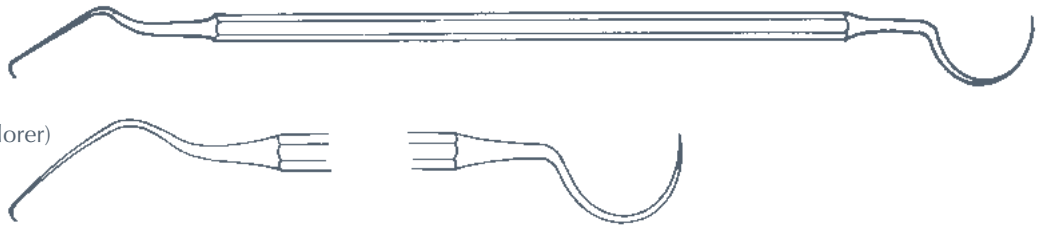

4068/04 fig 6



4068/05 fig 8



4068/06 fig 9



4068/07 fig 11 (Briault)

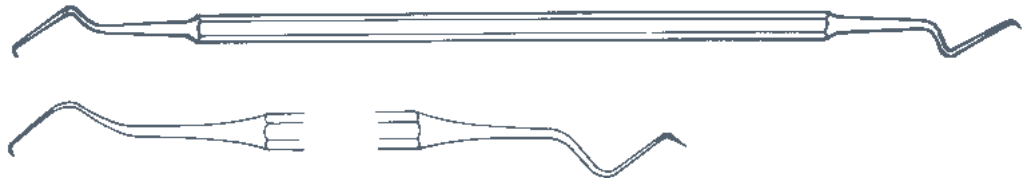

4068/08 fig 13







## HAND INSTRUMENTS



### Probe

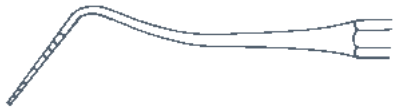

4068/09 fig 14W (Pocket Measuring)



4068/10 fig 37

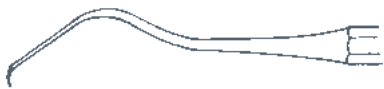

4068/11 fig 48

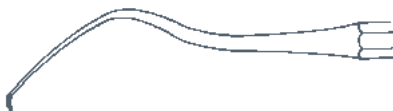

4068/12 fig 49



4068/13 fig 54

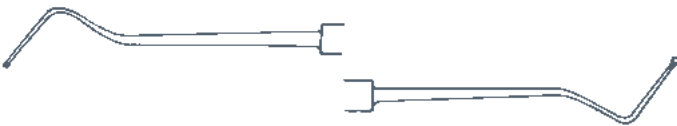

4068/14 Cross Calculus



4068/15 Holst



4068/16 Holst A



4068/17 fig 5/6



## HAND INSTRUMENTS

### Probe, Finetine

4068/20 fig FT6



4068/21 fig FT8



4068/22 fig FT9

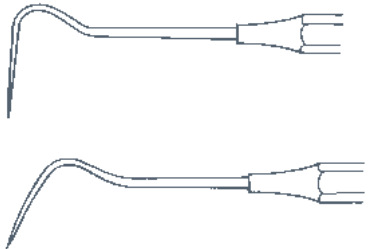

4068/23 fig FT54



4068/24 fig FT5/8

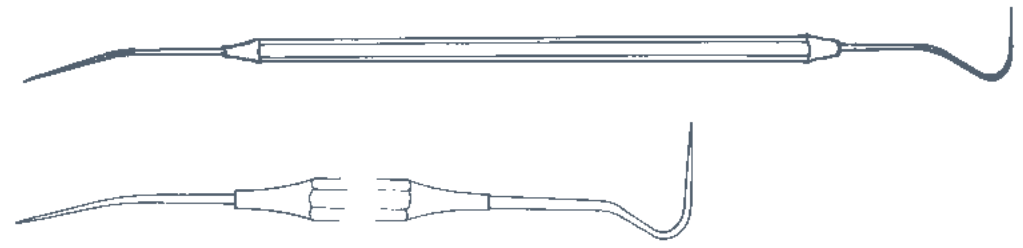

4068/25 fig FT8/9

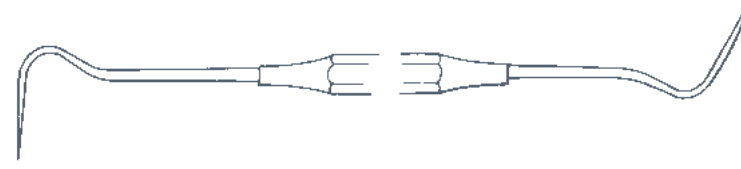

4068/26 fig FT5

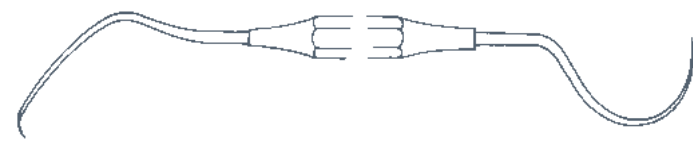

4068/27 fig FT11 (Briault)



4068/28 fig FT12 (Weston)





## HAND INSTRUMENTS



### Scalers

Curette, single end  
4069/01 fig 2L

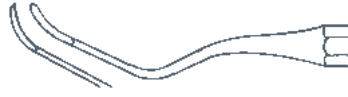

Curette, single end  
4069/02 fig 2R

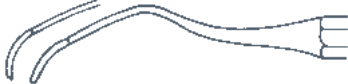

Curette, single end  
4069/03 fig 4L

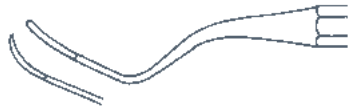

Curette, single end  
4069/04 fig 4R

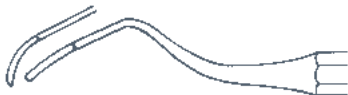

Curette, single end  
4069/05 fig 13

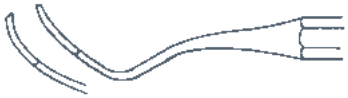

Curette, single end  
4069/06 fig 14

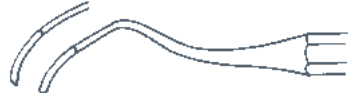

Darby Perry, single end  
4069/07 fig 111



Darby Perry, single end  
4069/08 fig 121



Guys, single end  
4069/09 fig G1



Guys, single end  
4069/10 fig G2



Guys, single end  
4069/11 fig G3



Guys, single end  
4069/12 fig G4



Howe, single end  
4069/13 fig 65



Guys, single end  
4069/14 fig 66

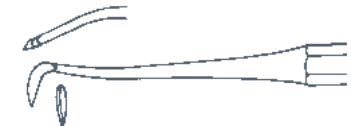

Howe, single end  
4069/15 fig 67



Hygienist, single end  
4069/16 fig H3



Hygienist, single end  
4069/17 fig H4

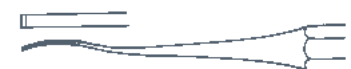



## HAND INSTRUMENTS

### Scalers



Hygienist, single end  
4069/18 fig H5



Nilsen, single end  
4069/27 fig 195A



Hygienist, single end  
4069/19 fig H6



Peridontal Hoe,  
single end  
4069/28 fig 4C

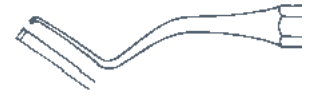

Hygienist, single end  
4069/20 fig H7



Peridontal Hoe,  
single end  
4069/29 fig 7C

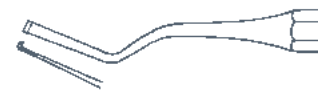

Hygienist, single end  
4069/21 fig H8



Peridontal Hoe,  
single end  
4069/30 fig 8C

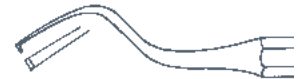

Hygienist, single end  
4069/22 fig H9



Peridontal Hoe,  
single end  
4069/31 fig 9C



Jaquettes, single end  
4069/23 fig 1



Towner, single end  
4069/32 fig U15



Jaquettes, single end  
4069/24 fig 2

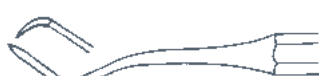

Williams, single end  
4069/33 fig 42

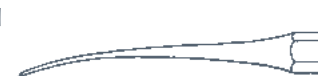

Jaquettes, single end  
4069/25 fig 3



Younger Good,  
single end  
4069/34 fig 72



Nilsens, single end  
4069/26 fig 195



Younger Good,  
single end  
4069/35 fig 73





## HAND INSTRUMENTS



### Scalers

Cumine, double ended  
4071/01 fig 152

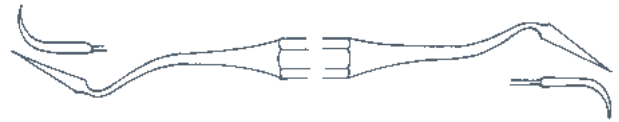

Scaler, double ended  
4071/04 fig 6AF



Cumine, double ended  
4071/02 fig 152A



Shepherd, double ended  
4071/05 fig 197



Probe/Scaler, double ended  
4071/03 fig 4



Shepherd, double ended  
4071/06 fig 198



### Spatulas

Weston  
4073/01 fig 3



double ended  
4073/02 fig 8



plaster mixer  
4073/03 fig 8X



## DENTAL FILES

### Millers

double ended  
4062/01 fig 52



## DENTAL KNIVES

### Blakes Universal

4063/01 balanced grip

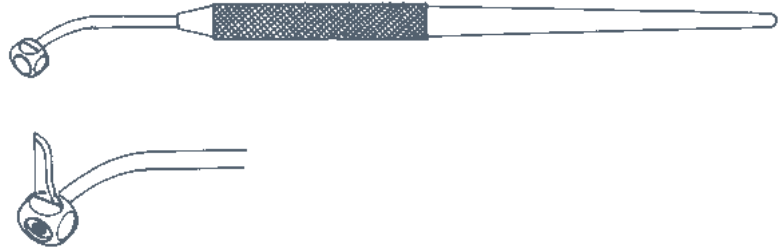

### Plaster

4106/29 wood handle



### Wax

wood handle  
4052/14 large  
4052/15 small



## DENTAL MIRRORS

### Plain

stainless steel mount, rear surface

4066/01 size 3, 20mm

4066/02 size 4, 22mm

4066/03 size 5, 24mm

4066/04 size 6, 26mm

stainless steel mount, front surface

4066/20 size 4, 22mm

4066/21 size 5, 24mm

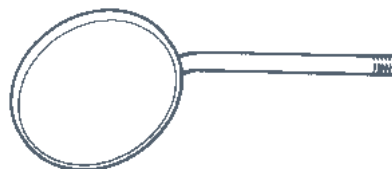



## DENTAL MIRRORS

### Handle



stainless steel, round  
4066/25 smooth



stainless steel  
4066/26 serrated

## DENTAL PLIERS

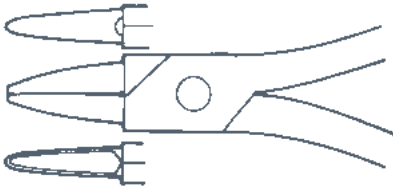
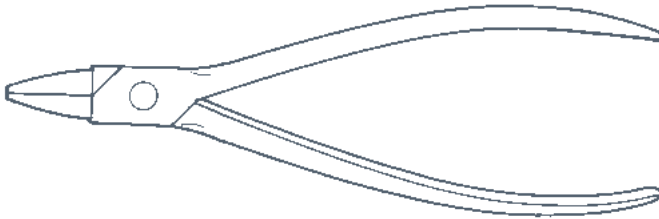

### Marthew

plate  
4080/01 fig 26



### Schroeder

pointed  
4080/02 fig 42M

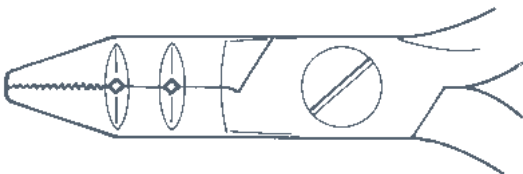

### Universal

wire bending  
4080/03 fig 57

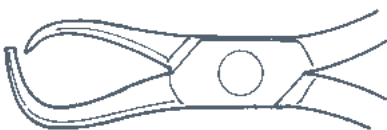

### Pullen

band removing  
4080/04 fig 58



## DENTAL PLIERS

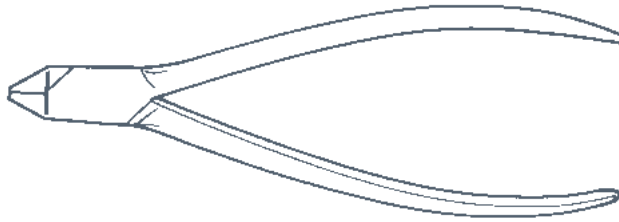

### Adams

universal wire bending, tungsten carbide  
4080/07 fig 64TC

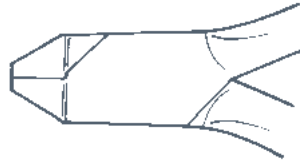

### Johnson

contouring  
4080/13 fig 114



### Adams

arch and spring bending, tungsten carbide  
4080/09 fig 65TC

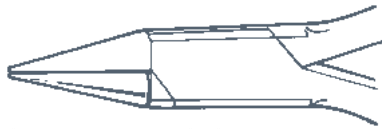

### Ligature Cutters

4080/16 fig 150M



### Flat Nose

4080/11 fig 102M

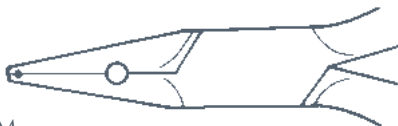

### Band Removing

anterior  
4080/17 fig 345

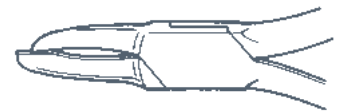

### Howe

4080/12 fig 110

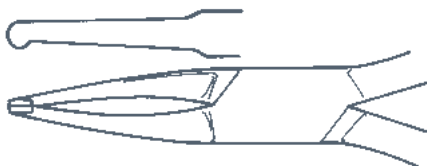

posterior  
4080/18 fig 347







## DENTAL SCISSORS

### Gum

open shank, straight 115mm

4082/01 fig 1



open shank, curved 115mm

4082/02 fig 2

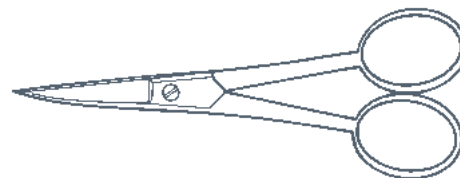

### Gum

closed shank, straight 115mm

4082/04 fig 4



closed shank, curved 115mm

4082/05 fig 5

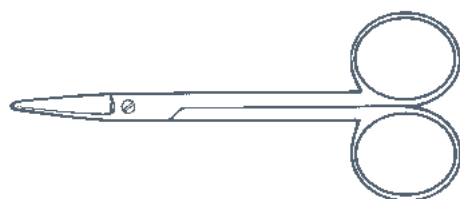

### Crown and Collar

Bee Bee, curved, 110mm

4082/09 fig 9



Bee Bee, straight, 110mm

4082/12 fig 12

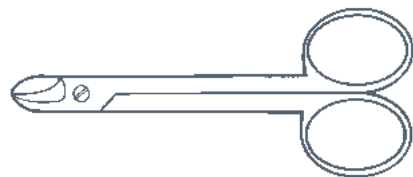

### Students

150mm

4082/13 fig 13

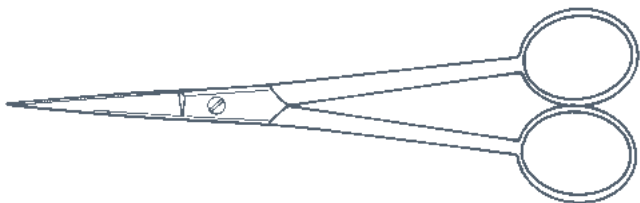

### Dressing

125mm

4082/14 fig 14

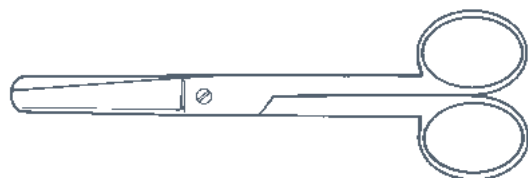

### Surgical

115mm

4082/19 fig 19

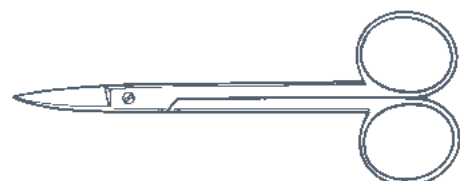



## DENTAL TWEEZERS

### Perry Dressing

125mm

4083/01 fig 6



### College Dressing

plain jaws, 150mm

4083/02 fig 8

serrated, 150mm

4083/03 fig 8S



### Plugging

150mm

4083/04 fig 11



### Guttman

160mm

4083/05 fig 13



### Dressing

160mm

4083/06 fig 17S



### Furnace

4083/07 200mm



### Self-Locking

4083/08 160mm





## MATRIX CLAMP

### Siqveland

complete with 12 stainless steel bands

4110/01 wide

4110/11 narrow

spare bands, pack of 12

4110/02 wide

4110/12 narrow



## DENTAL SYRINGES

### Chip

4102/48 No 2

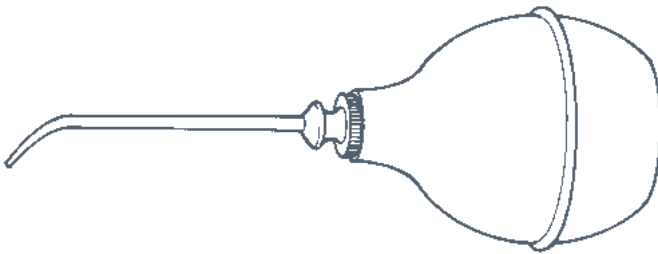

### Cartridge

4111/01 1.8cc

4111/11 2.2cc

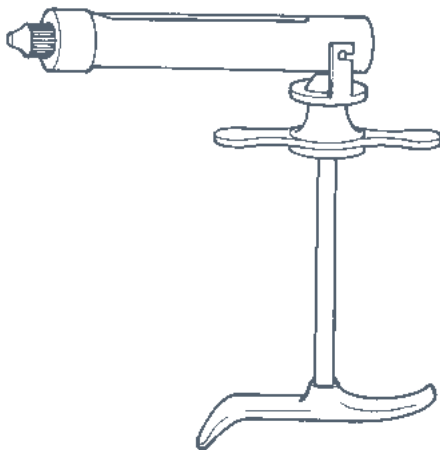

### Aspirating

4111/02 1.8cc

4111/12 2.2cc

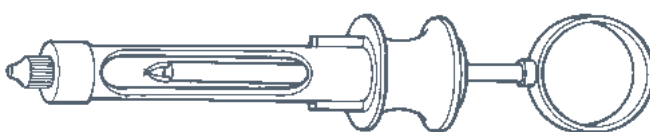



CHIR



## CHIROPODY INSTRUMENTS



### Blacks File

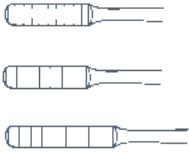

5001/00 fine

5001/01 medium

5001/02 tungsten carbide



### Probe, Swan Neck

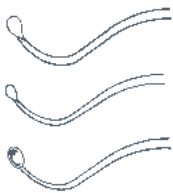

5002/01 flat, medium

5002/02 flat, small

5002/03 cupped



### Beaver Blade Holder

5003/01 hexagonal



5003/02 round



### Nail Chisel

stainless steel

5005/01





## CHIROPODY KNIVES



5004/03 fig 49

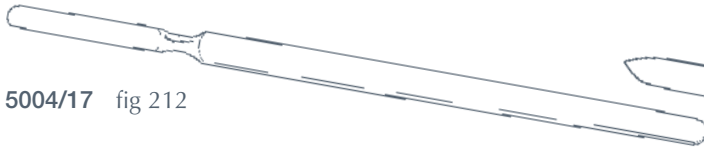

5004/17 fig 212

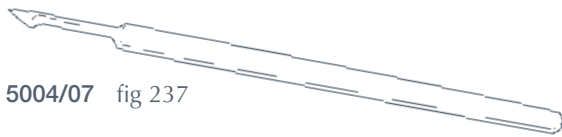

5004/07 fig 237



5004/06 fig 246

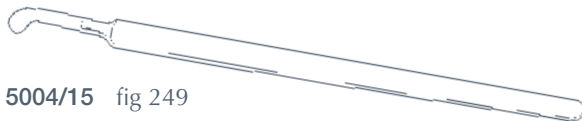

5004/15 fig 249

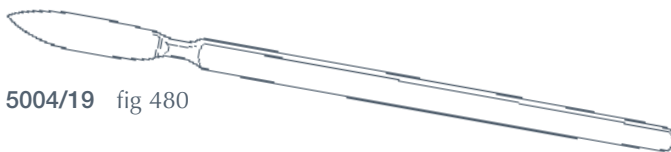

5004/19 fig 480

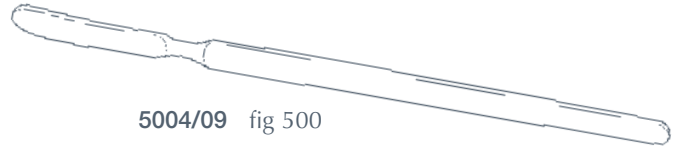

5004/09 fig 500



5004/18 fig 221



5004/01 fig 66



5004/04 fig 245

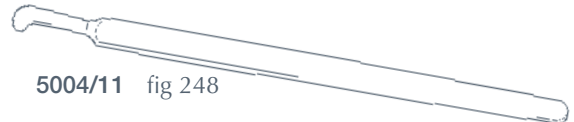

5004/11 fig 248

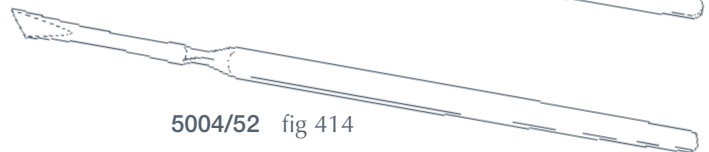

5004/52 fig 414

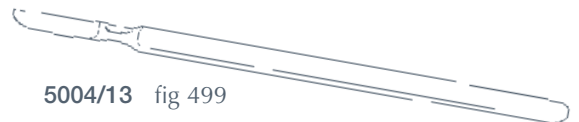

5004/13 fig 499

## NIPPERS

### Concave

stainless steel with catch

5006/01 140mm



stainless steel without catch

5006/02 140mm

### Flat

stainless steel with catch

5007/01 140mm



stainless steel without catch

5007/02 140mm

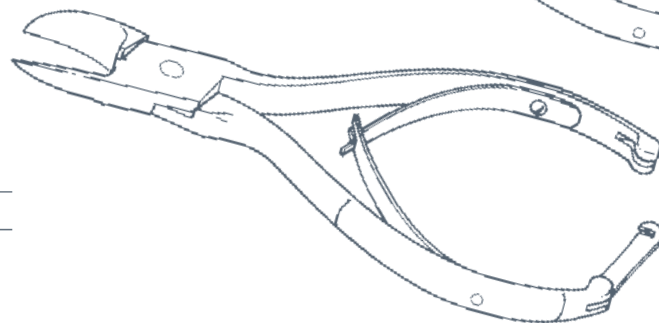
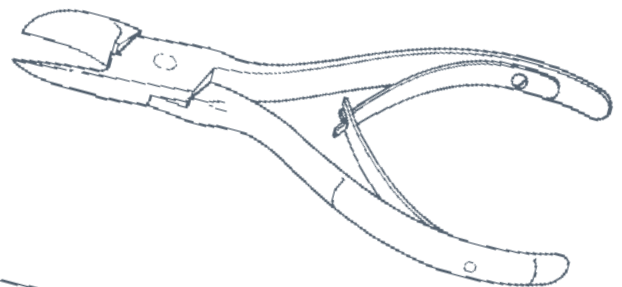



## NIPPERS

### Thwaites

for ingrowing nails

5008/01 130mm

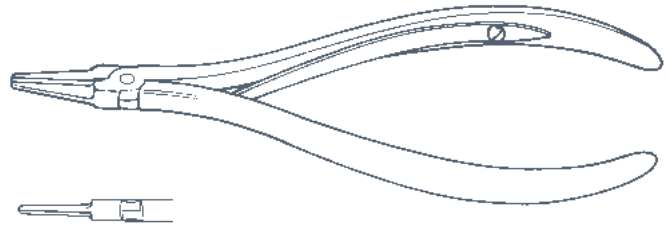

## SURGICAL SCISSORS

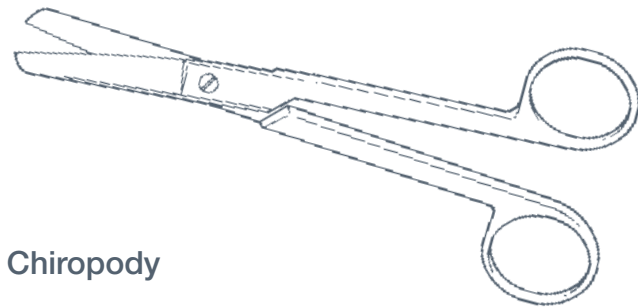

### Chiropody

short strong blades specifically designed to cut felt with ease

straight, blunt/blunt

5042/20 150mm

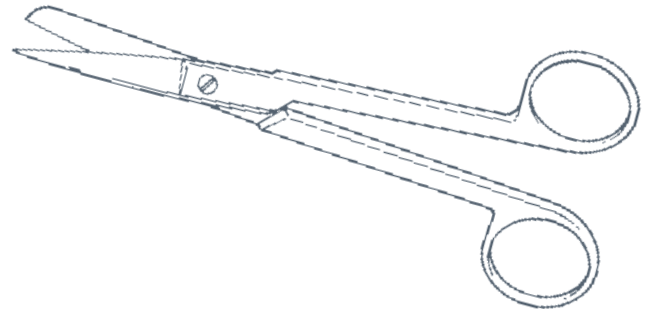

straight, blunt/sharp

5043/20 150mm

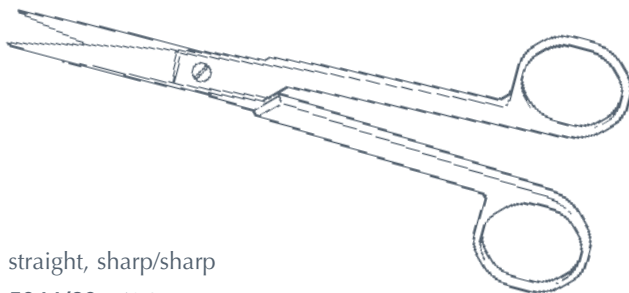

straight, sharp/sharp

5044/20 150mm

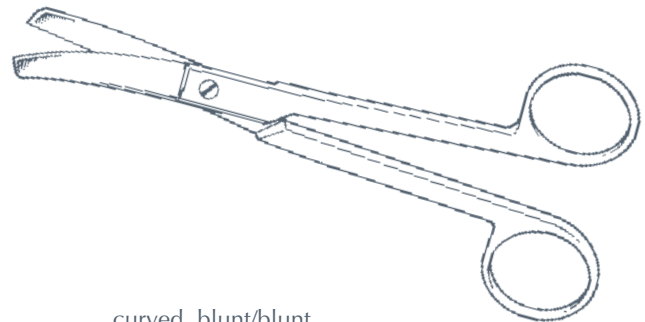

curved, blunt/blunt

5045/20 150mm

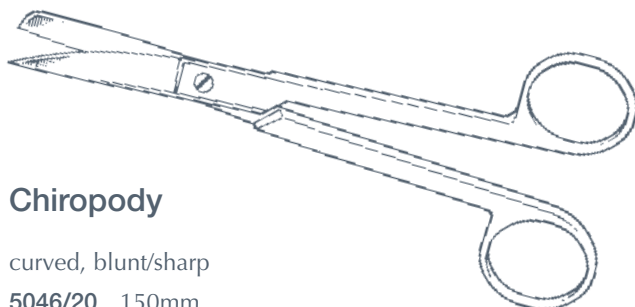

### Chiropody

curved, blunt/sharp

5046/20 150mm

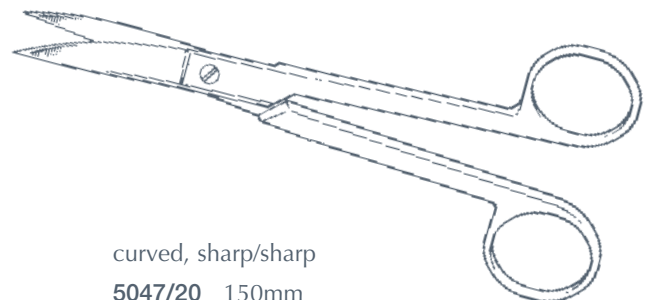

curved, sharp/sharp

5047/20 150mm



NEU





## ARTERY FORCEPS

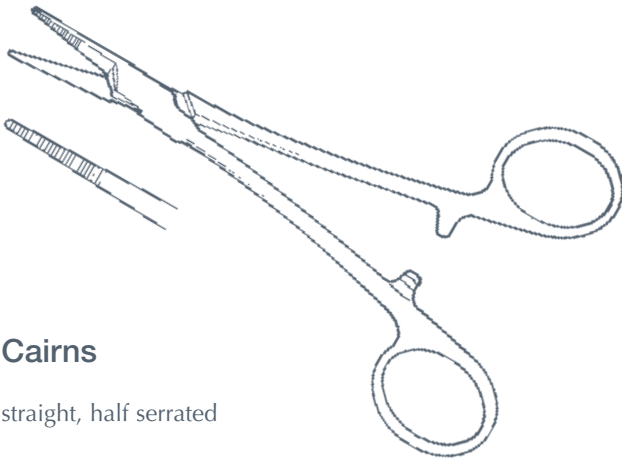

### Cairns

straight, half serrated

5105/05 145mm

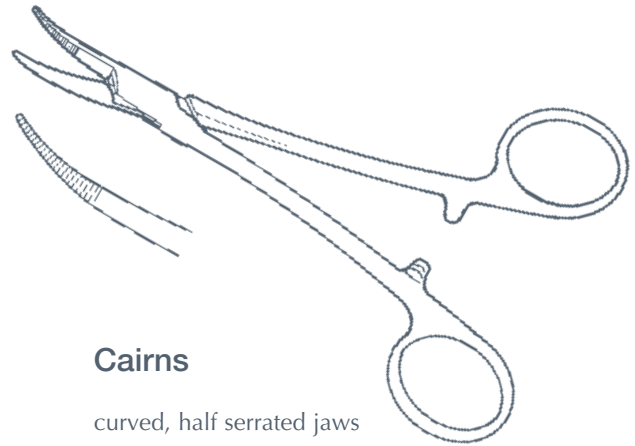

### Cairns

curved, half serrated jaws

5106/05 145mm

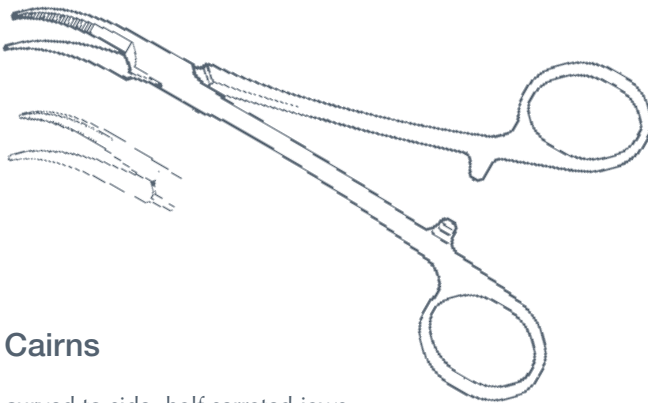

### Cairns

curved to side, half serrated jaws

5107/05 145mm

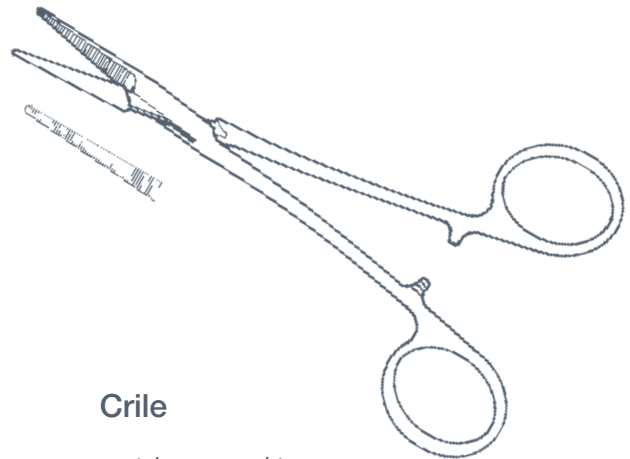

### Crile

straight, serrated jaws

5115/05 140mm

5115/10 160mm

5115/15 180mm

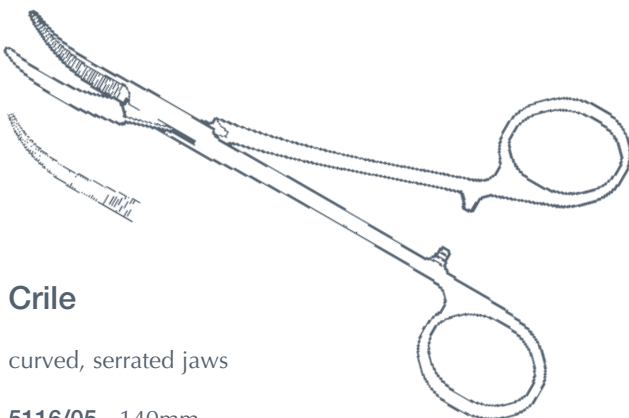

### Crile

curved, serrated jaws

5116/05 140mm

5116/10 160mm

5116/15 180mm



## ARTERY FORCEPS

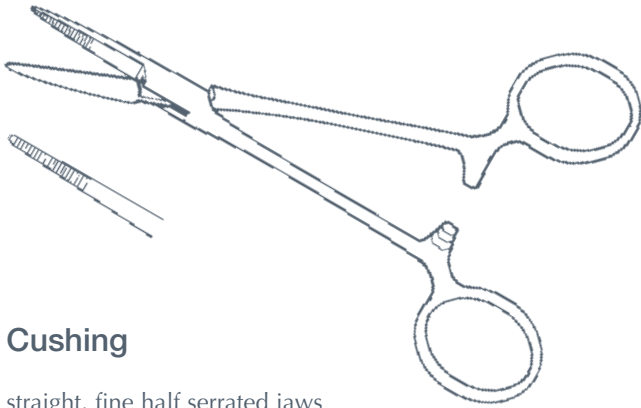

### Cushing

straight, fine half serrated jaws

5125/05 145mm

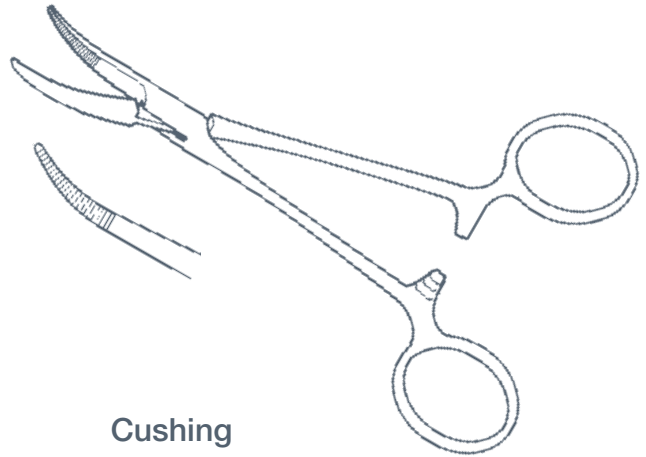

### Cushing

curved, fine half serrated jaws

5126/05 145mm

### Cushing

curved to side, fine half serrated jaws

5127/05 145mm

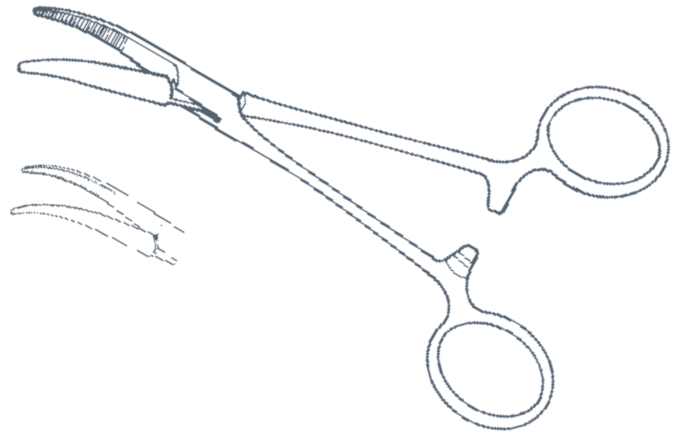

NEU

## BRACE

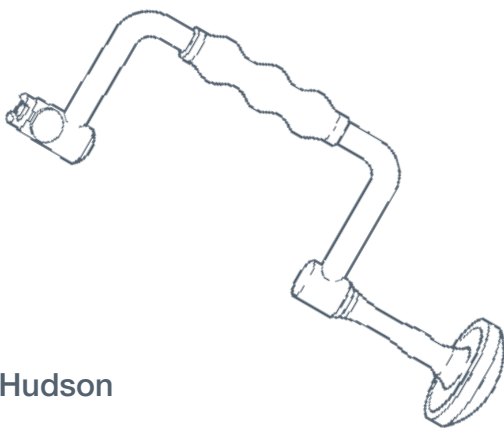

### Hudson

5135/05 universal fitting

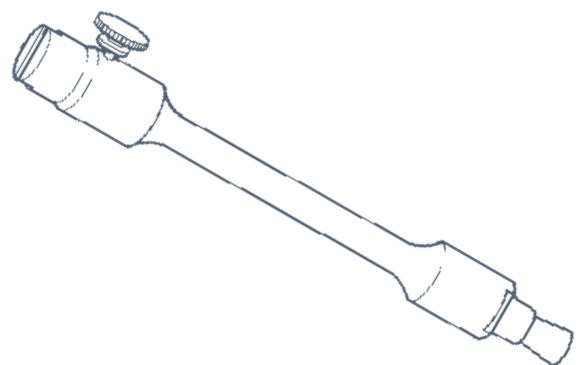

### Hudson

5140/05 for use with Hudson Brace



## BURS



### Hudson Conical

- 5150/05 9mm
- 5150/10 11mm
- 5150/15 13mm
- 5150/25 16mm



### Hudson Spherical

- 5155/10 9mm
- 5155/15 11mm
- 5155/25 13mm
- 5155/30 16mm
- 5155/35 19mm
- 5155/40 22mm

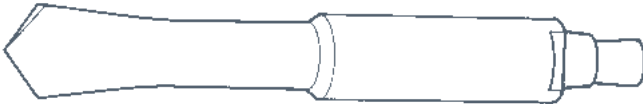

### Hudson Perforator

- 5160/03 8mm
- 5160/05 10mm
- 5160/10 12mm
- 5160/20 15mm



### Spiral Undercut

- 5165/05 100mm x 12mm



### Cone Ventricular

graduated in cms, luer fitting, with stilette

- 5185/05 1.22mm diameter
- 5185/10 1.63mm diameter
- 5185/15 2.03mm diameter



### Jefferson Ventricular

graduated in cms, luer fitting, with stilette

- 5195/05 60mm
- 5195/10 80mm
- 5195/15 100mm



## CANNULA

NEU



## CLIP FORCEPS

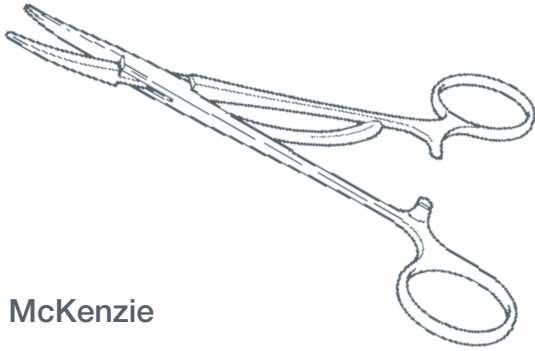

### McKenzie

curved, applying

5205/10 140mm

5205/15 175mm

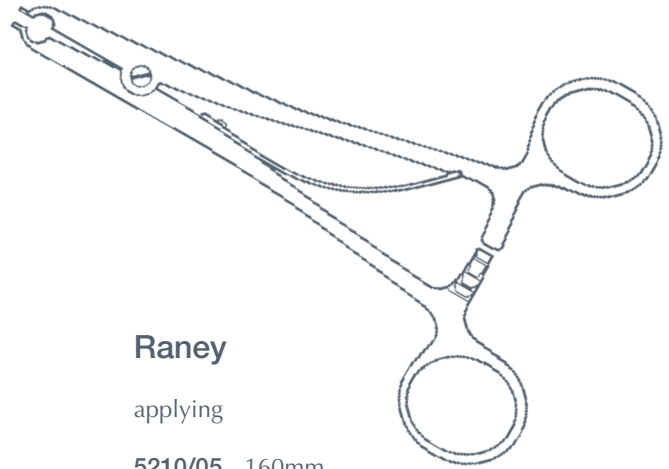

### Raney

applying

5210/05 160mm

## CURETTES

### American Spinal

straight, tufnol handle, 250mm

5230/05 2.0mm x 4mm

5230/10 2.5mm x 4.5mm

5230/15 2.75mm x 5mm

5230/20 3.0mm x 5.5mm

5230/25 3.25mm x 6mm

5230/30 4.0mm x 7mm

5230/35 6.0mm x 9.5mm

5230/40 7.0mm x 14mm

5230/45 9.0mm x 17mm

angled, tufnol handle, 250mm

5231/05 2.0mm x 4mm

5231/10 2.5mm x 4.5mm

5231/15 2.75mm x 5mm

5231/20 3.0mm x 5.5mm

5231/25 3.25mm x 6mm

5231/30 4.0mm x 7mm

5231/35 6.0mm x 9.5mm

5231/40 7.0mm x 14mm

5231/45 9.0mm x 17mm



NEU

## DISSECTING FORCEPS

### Adson Bayonet

serrated, fine

5240/05 190mm

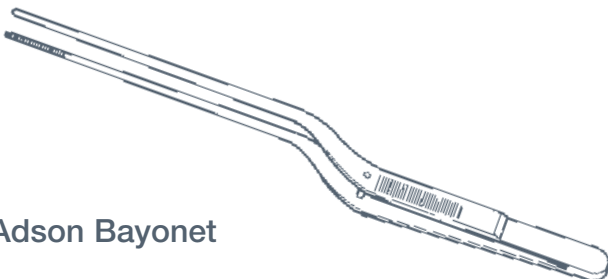

### Adson Bayonet

1/2 teeth

5241/05 190mm

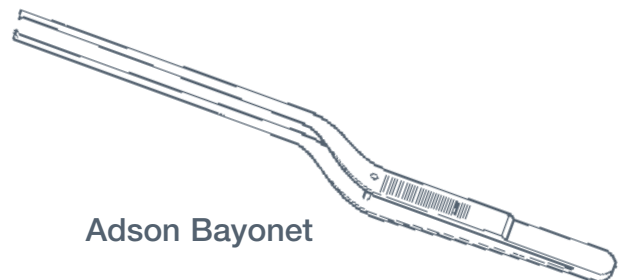



## DISSECTING FORCEPS

### Cairns



delicate, 2/3 teeth

5245/05 165mm

5245/10 215mm

### Dott (Cairns)



fine, 1/2 teeth

5250/05 175mm

### Jefferson



fine, 1/2 teeth

5255/05 175mm

### Pennybacker



3/4 teeth

5260/05 165mm

## DISSECTORS



### Pennybacker

double ended

5275/05 225mm



### Swedish

double ended, light model

5280/05 175mm



## DRESSING FORCEPS

### Cairns (Dott)

fine serrated jaws  
5290/05 180mm



### Cairns

medium serrated jaws  
5290/10 215mm



### Jefferson

serrated jaws  
5295/05 180mm



## DURAL HOOKS

### Adson

blunt  
5305/05 190mm



### Adson

fine, sharp  
5306/05 190mm



### Cairns

fine, sharp  
5310/05 125mm



### Cairns

sharp  
5311/05 125mm





## ELEVATORS

### Adson Periosteal

straight

5335/05 165mm x 7mm wide



### Adson Periosteal

curved

5336/05 165mm x 5mm wide

5336/10 165mm x 7mm wide



### Cobb

5340/05 275mm x 10mm

5340/10 275mm x 13mm

5340/15 275mm x 19mm



### Pennybacker

curved, sharp

5345/05 160mm x 6mm wide



## GOUGES

NEU

### Capener

cranked, tufnol handle, length 235mm

5355/05 6mm

5355/10 8mm

5355/15 11mm

5355/20 16mm

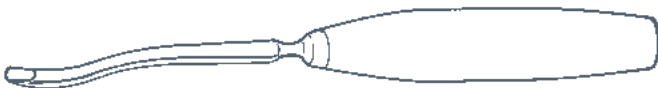



## RETRACTORS

### Cairns Strip

malleable, copper

**5470/05** 200mm x 6mm

**5470/10** 200mm x 8mm

**5470/15** 200mm x 10mm

**5470/20** 200mm x 11mm

**5470/25** 200mm x 13mm

**5470/30** 200mm x 16mm

**5470/35** 200mm x 19mm

**5470/40** 200mm x 25mm



### Charnley Laminectomy

set of 2, one with central hook and one with 2 blunt hooks together with spain weight (1.47kg) and chain

**5475/05** 65mm x 175mm

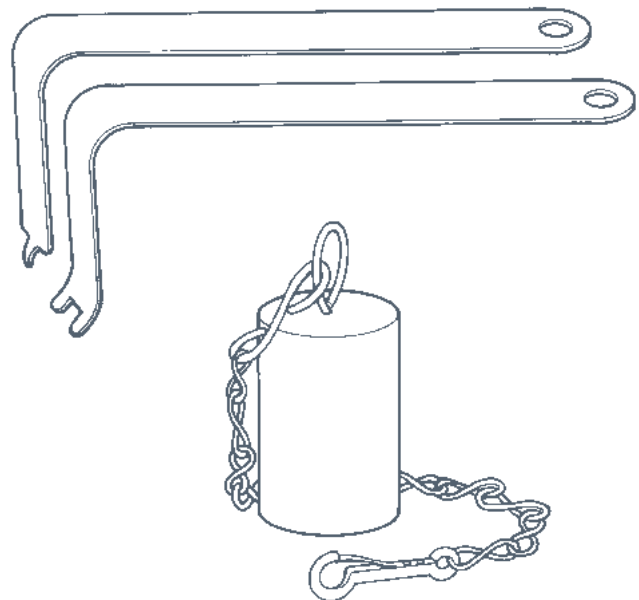





## RETRACTORS



### Cushing

5480/05 190mm

5480/10 280mm



### Dandy

straight

5485/05 200mm



### Hibbs

200mm

5495/05 10mm x 38mm blades

5495/10 16mm x 54mm blades

5495/15 25mm x 70mm blades



### Love

nerve root

5500/05 straight

5501/05 angled

5502/05 right angled

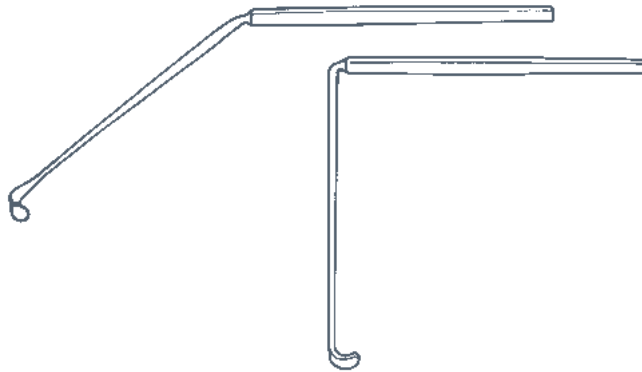

### O'Connell

double ended

5510/05 215mm



## RETRACTORS, SELF RETAINING

### Cone

blunt, 3/4 prong

5525/05 125mm

5525/10 160mm

5525/15 200mm

5525/20 260mm

sharp, 3/4 prong

5526/05 125mm

5526/10 160mm

5526/15 200mm

5526/20 260mm

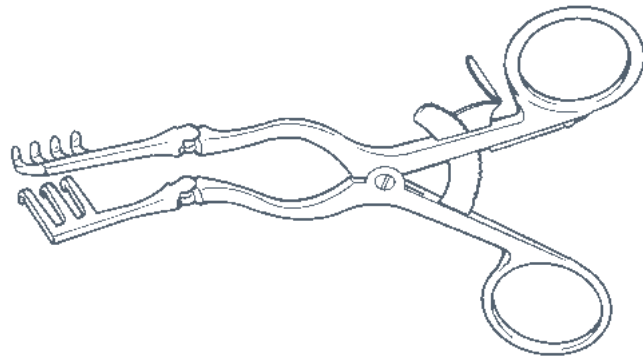

### Harvey-Jackson

hinged arms, 305mm

5550/05 38mm x 44mm blades

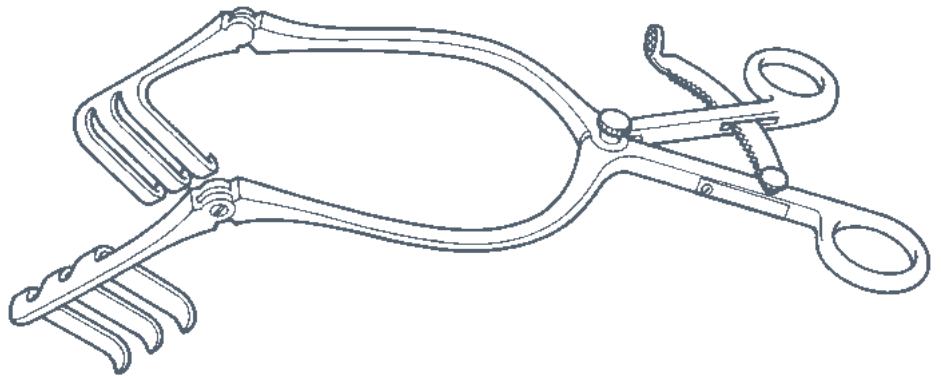



## RETRACTORS, SELF RETAINING

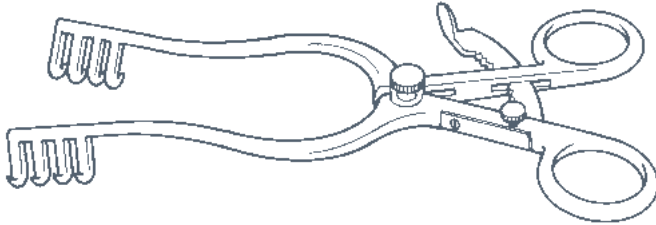

**Henderson**

blunt  
5560/05 135mm

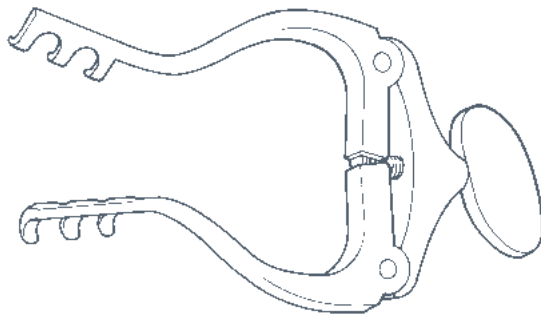

**Jansen**

blunt  
5565/05 112mm

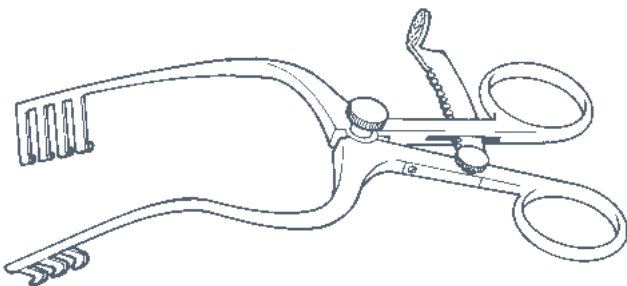

**Jefferson**

curved, blunt, 3/4 prong  
5575/05 140mm

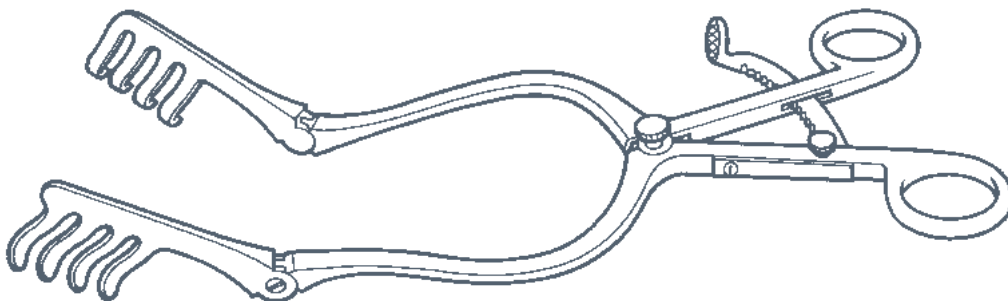

**Mayo-Adson Laminectomy**

hinged arms  
5580/05 290mm



## RONGEURS

### Beck

130mm effective length

5625/05 2mm bite

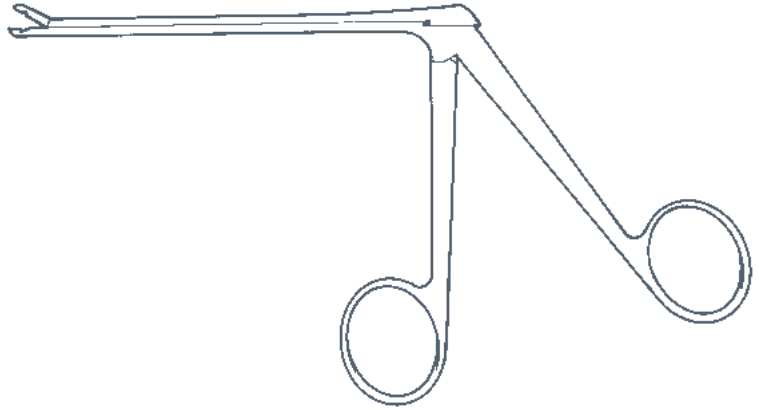

### Cushing

straight, 130mm effective length

5630/05 4mm bite

5630/10 5mm bite

5630/15 7mm bite

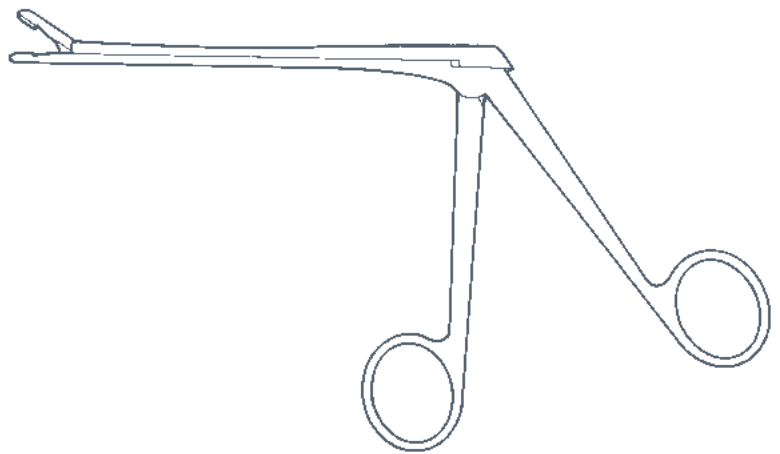

### Cushing

angled upward, 130mm effective length

5631/05 3mm bite

5631/10 4mm bite

5631/15 5mm bite

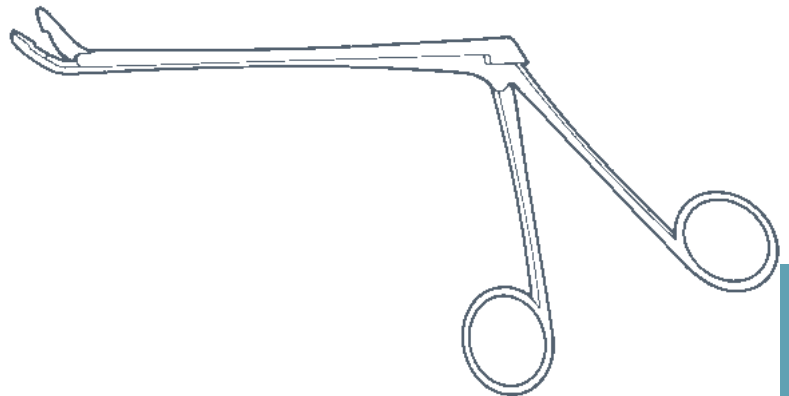

### Cushing

angled downward, 130mm effective length

5632/05 3mm bite

5632/10 4mm bite

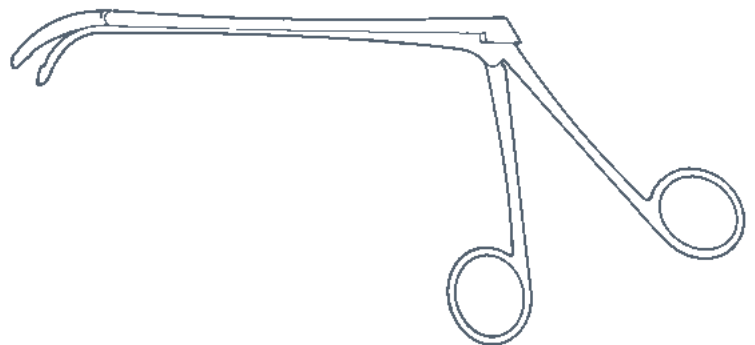



## RONGEURS

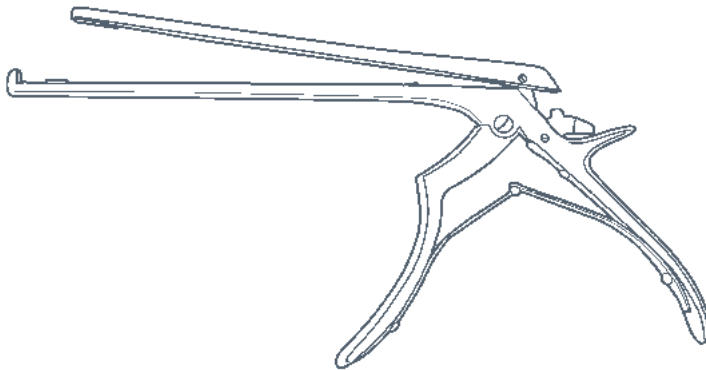

### Ferris-Smith-Kerrison

one piece hinge system allows ease of disassembly, cleaning and reassembly

upward cutting, 180mm effective length

**5637/05** 1mm bite

**5637/10** 2mm bite

**5637/15** 3mm bite

**5637/20** 4mm bite

**5637/25** 5mm bite

**5637/30** 6mm bite

40° upward cutting, 180mm effective length

**5638/05** 1mm bite

**5638/10** 2mm bite

**5638/15** 3mm bite

**5638/20** 4mm bite

**5638/25** 5mm bite

**5638/30** 6mm bite

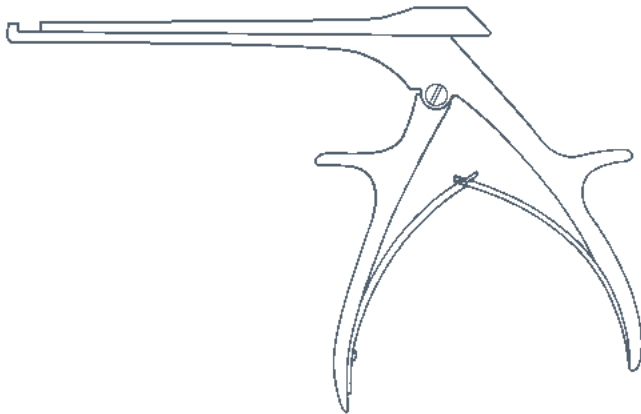

### Kerrison

upward cutting, 180mm effective length

**5671/05** 2mm bite

**5671/10** 3mm bite

40° upward cutting, 180mm effective length

**5673/05** 3mm bite

**5673/10** 4mm bite

**5673/15** 5mm bite

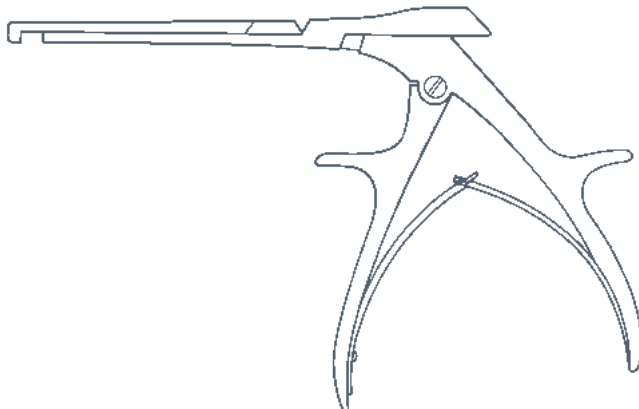

### Kerrison

downward cutting, 180mm effective length

**5675/05** 2mm bite

**5675/10** 3mm bite

40° downward cutting, 180mm effective length

**5677/05** 3mm bite

**5677/10** 4mm bite

**5677/15** 5mm bite



## RONGEURS

### Love-Grunwald

straight, 180mm effective length

5685/05 3mm bite

curved upward, 180mm effective length

5686/05 3mm bite

curved downward, 180mm effective length

5687/05 3mm bite

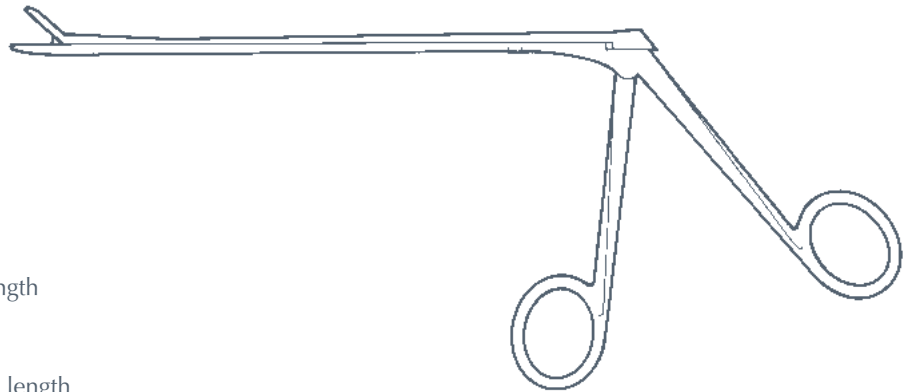

### Northfield

curved upward, 130mm effective length

5690/05 4mm bite

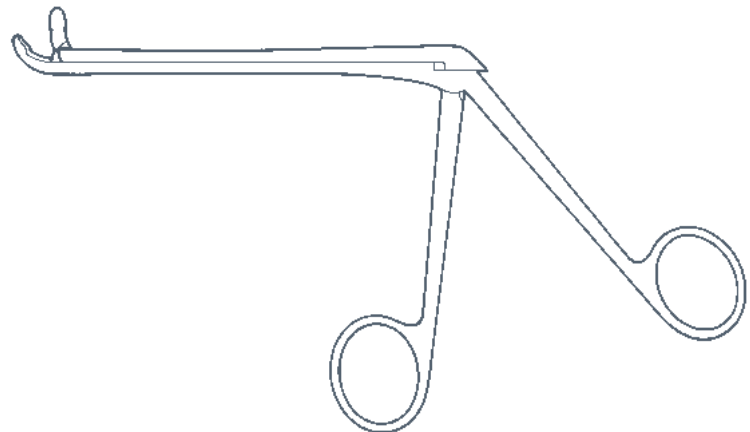

### Pennybacker

straight, 115mm effective length

5695/05 3mm bite

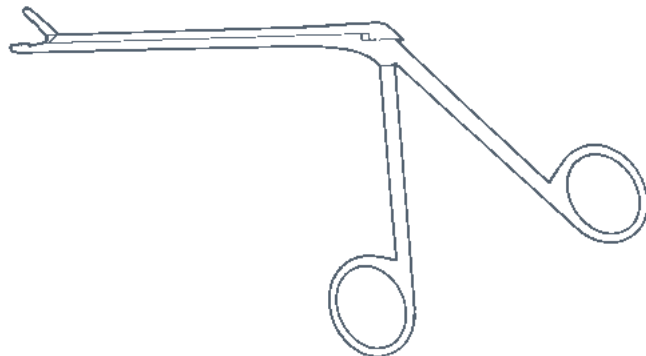



## RONGEURS

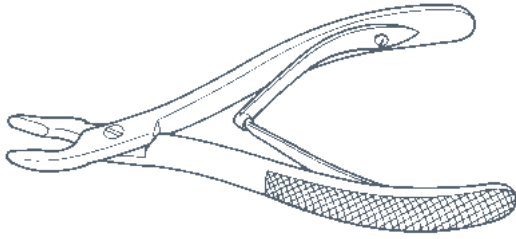

### Glasgow

curved on flat, screw joint, 145mm  
5715/05 4mm bite

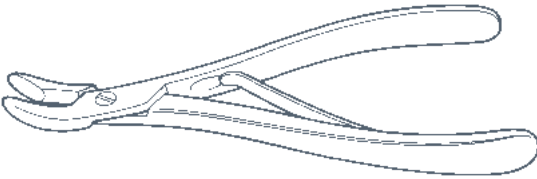

### Jansen

small curve, screw joint, 150mm  
5720/05 8mm bite

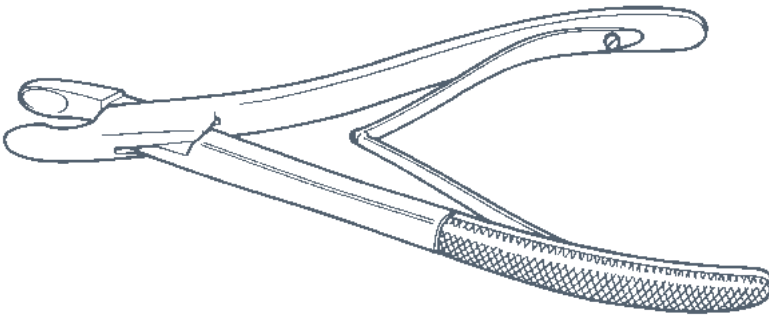

### Northfield

straight, 200mm  
5725/05 10mm bite

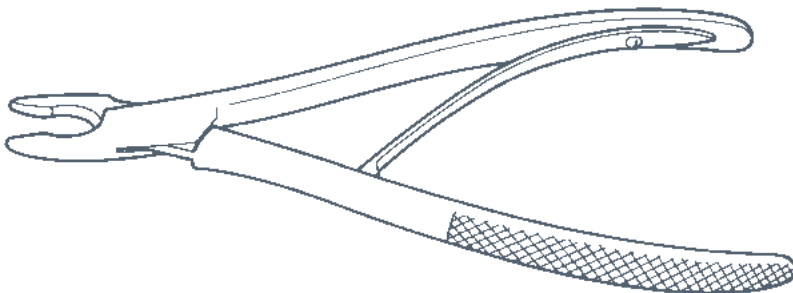

### Pennybacker

straight, fine jaw, 200mm  
5730/05 4mm bite



## RONGEURS

### Ruskin

curved on flat, compound action, 185mm  
5735/05 6mm bite

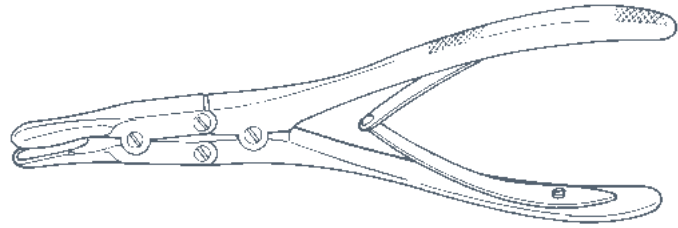

### Trotter

angled to side, screw joint, 200mm  
5745/05 10mm bite

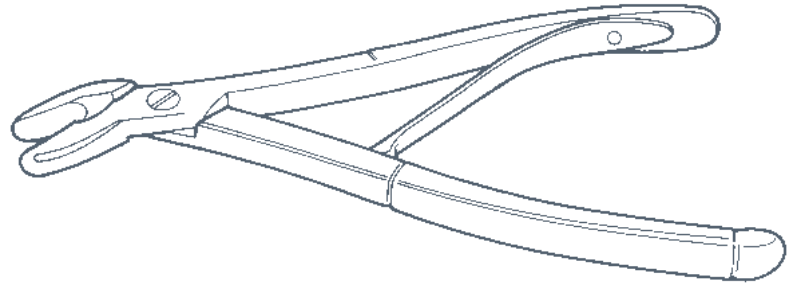

### Van Havre (Sargent)

curved on flat, compound action, 225mm  
5755/05 10mm bite

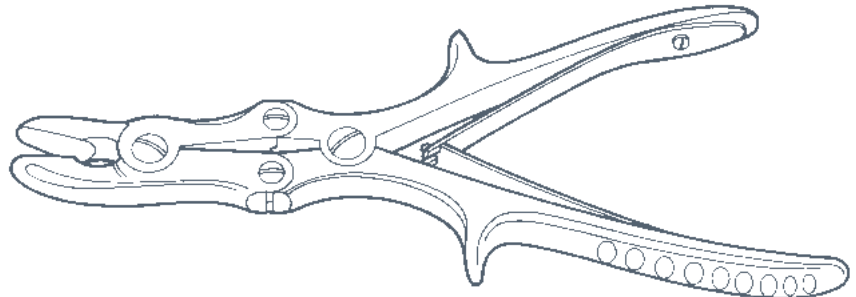

## SAWS

### De Martel Gigli Guide

5780/05 305mm



### Gigli

5785/05 305mm  
5785/10 500mm

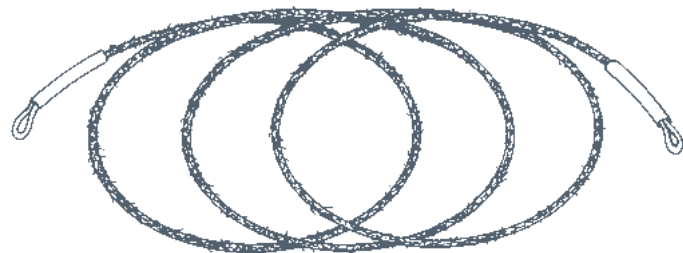

### Gigli Handle

pair  
5790/05 50mm







## SCISSORS

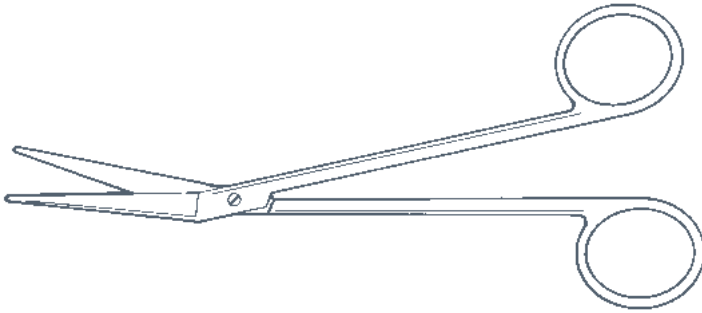

### Cairns

angled on flat  
5800/05 175mm



### McKissock

dural, straight  
5825/05 145mm



### McKissock

dural, curved  
5826/05 145mm

## SHEARS

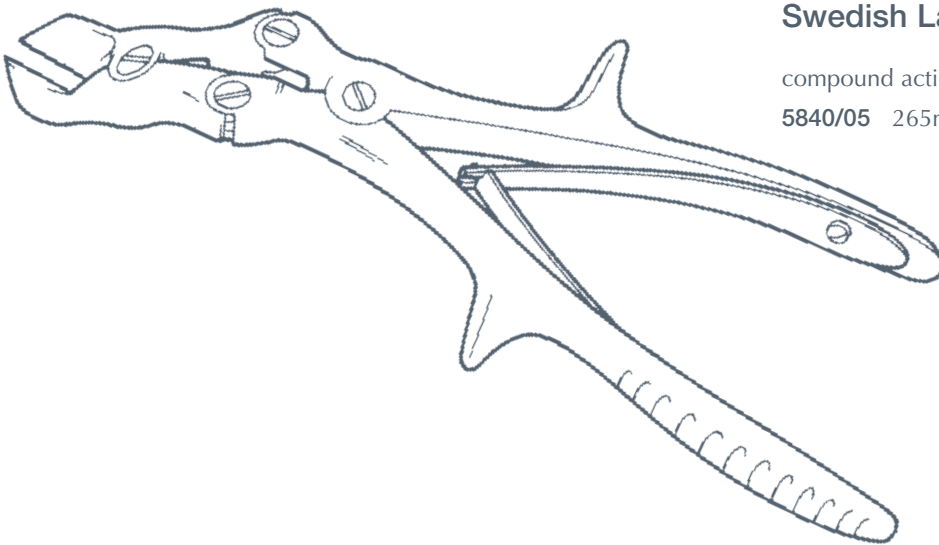

### Swedish Laminectomy

compound action  
5840/05 265mm

NEU

## SUCTION TUBES



### Adson Frazier

angled, 175mm  
5880/05 7fg, 2.3mm  
5880/10 8fg, 2.7mm  
5880/15 9fg, 3.0mm





## AWLS

### Bone

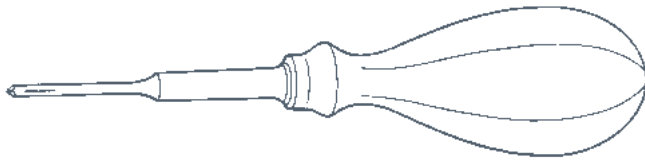

straight with eye

6075/05 2.0mm diameter, 125mm

6075/10 2.4mm diameter, 130mm

6075/15 2.8mm diameter, 145mm

6075/20 3.2mm diameter, 160mm

6075/25 3.6mm diameter, 165mm

6075/30 4.0mm diameter, 175mm

## BONE CURETTES



### Charnley

6085/05 small, 300mm

6085/10 large, 375mm



### Stanley Boyd

double ended

6090/05 small, 150mm

6090/10 medium, 200mm

6090/15 large, 250mm



### Volkman

double ended, 220mm

6095/05 small

6095/10 medium

6095/15 large



### Volkman

single ended, oval, 180mm

6096/05 No.1

6096/10 No.2

6096/15 No.3

6096/20 No.4

6096/25 No.5

6096/30 No.6





## BONE CUTTING

### FORCEPS

#### Horsley

compound action, straight

6100/05 270mm

compound action, angled

6101/05 270mm

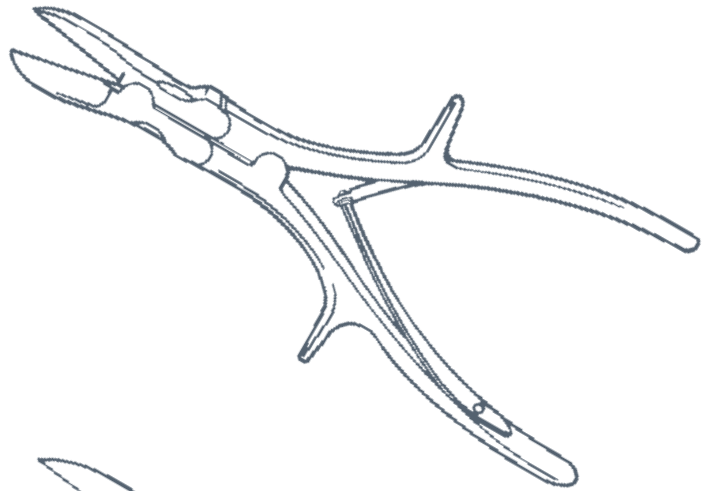

#### Liston

straight

6105/05 150mm

6105/10 180mm

6105/15 200mm

6105/20 230mm

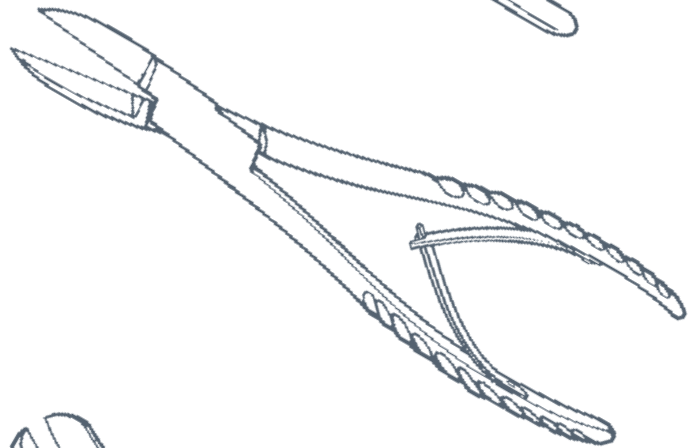

#### Liston

curved

6106/05 150mm

6106/10 180mm

6106/15 200mm

6106/20 230mm

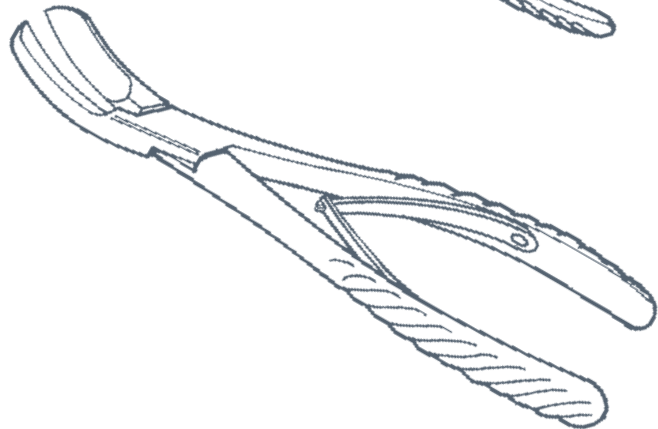

#### Liston

angled

6107/05 150mm

6107/10 180mm

6107/15 200mm

6107/20 230mm

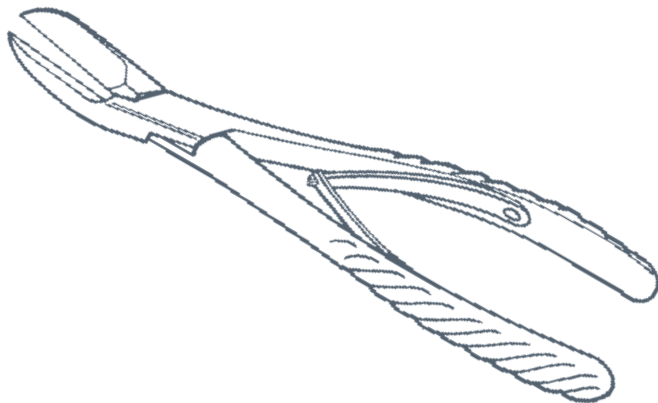



## BONE CUTTING FORCEPS

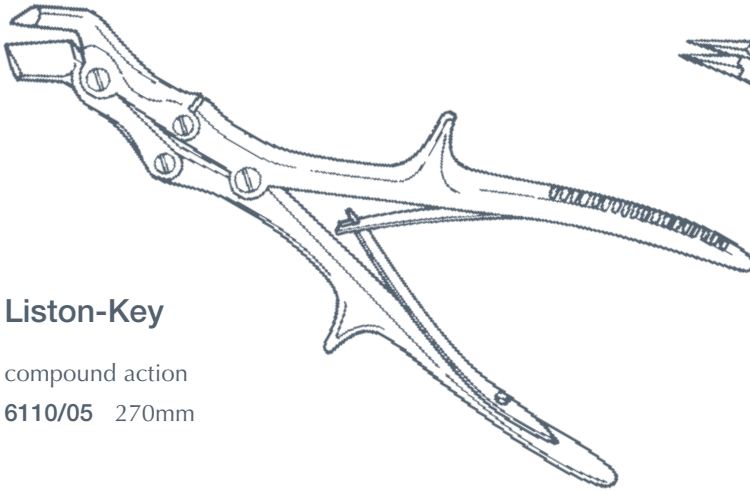

**Liston-Key**

compound action  
6110/05 270mm



**McIndoe**

compound action  
6115/05 190mm

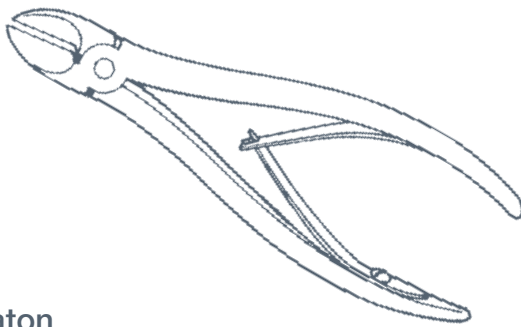

**Paton**

6120/05 140mm

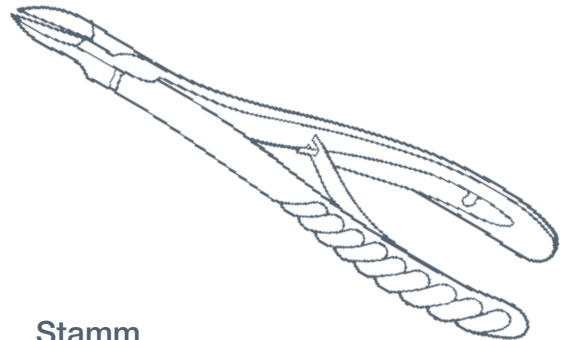

**Stamm**

6125/05 140mm

## BONE HOLDING CLAMPS

ORTH

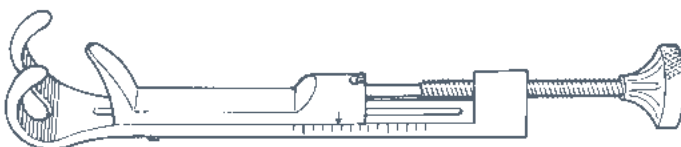

**Lowman**

6130/05 120mm  
6130/10 175mm  
6130/15 200mm  
6130/20 220mm



## BONE HOLDING FORCEPS

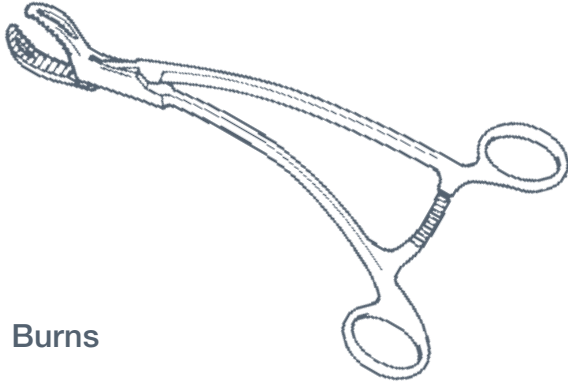

**Burns**

6135/05 190mm

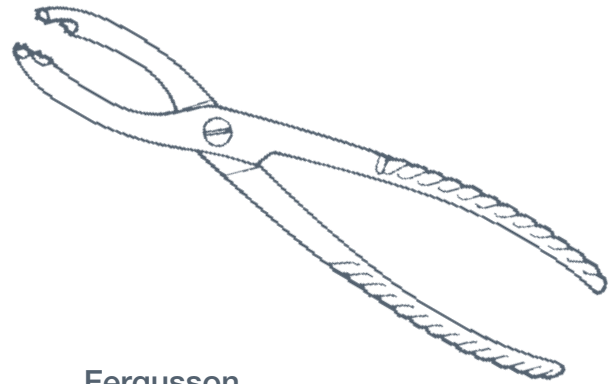

**Fergusson**

screw joint

6140/05 150mm

6140/10 200mm

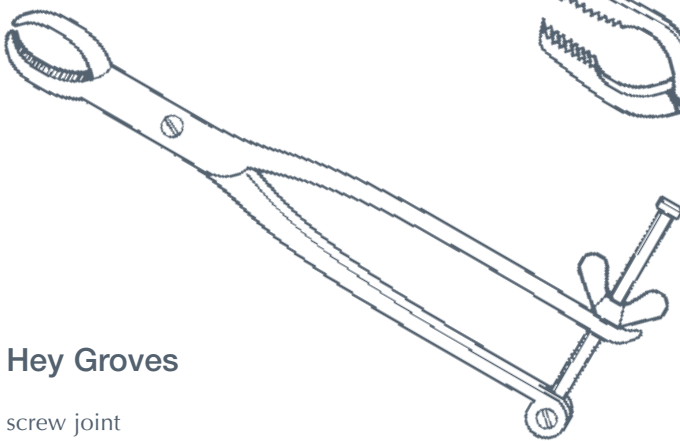

**Hey Groves**

screw joint

6145/05 200mm

6145/10 255mm

6145/15 305mm

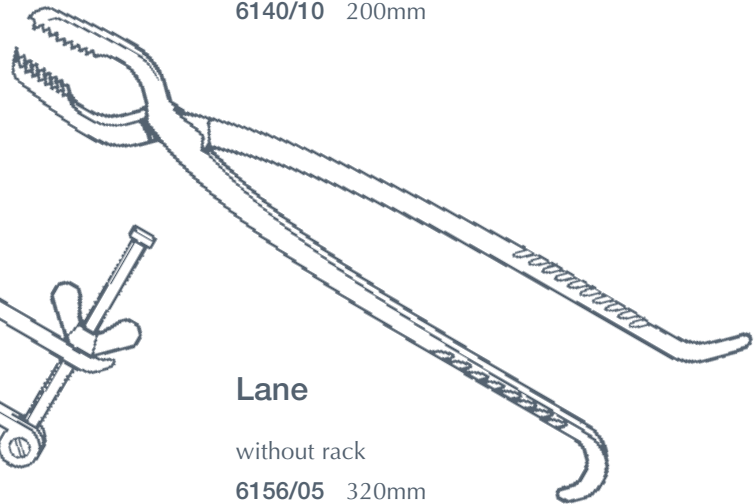

**Lane**

without rack

6156/05 320mm

6156/10 450mm

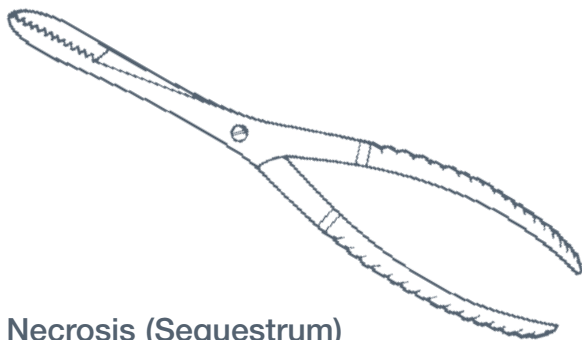

**Necrosis (Sequestrum)**

straight, screw joint

6165/05 190mm

6165/10 200mm

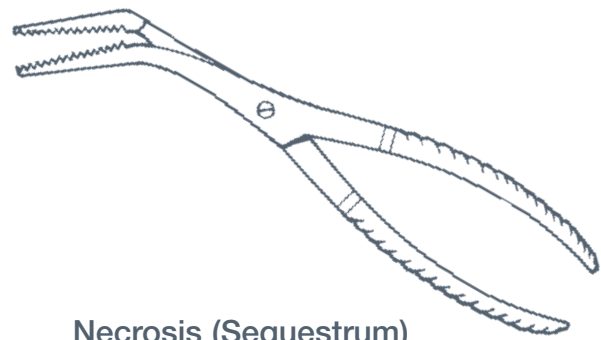

**Necrosis (Sequestrum)**

angled, screw joint

6166/05 190mm

6166/10 200mm



## BONE HOLDING FORCEPS

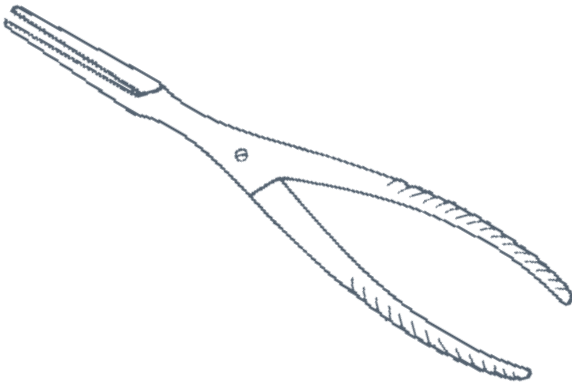

### Necrosis (Sequestrum)

long fine jaws, screw joint

6167/10 200mm

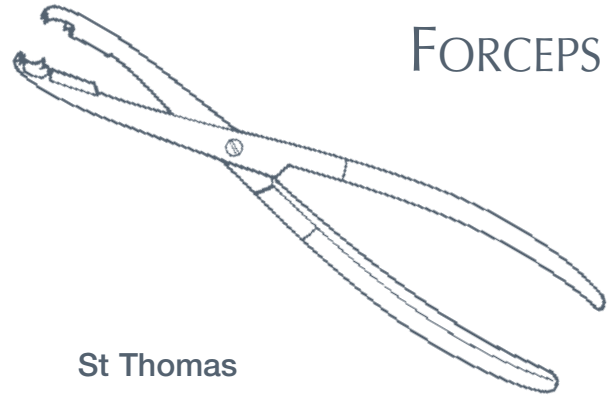

### St Thomas

screw joint

6170/05 175mm

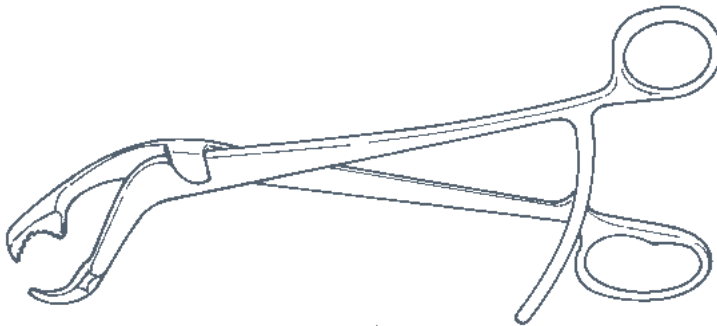

### Verbrugge

6180/05 250mm, 9.5mm jaw

6180/10 260mm, 10.5mm jaw

6180/15 270mm, 12mm jaw

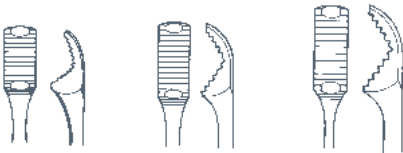

## BONE HOOKS



### Langenbeck

6183/05 195mm



### Kocher

6184/05 220mm



## BONE LEVERS

### Bankhart

6185/05 300mm



### Bennett

6190/05 240mm

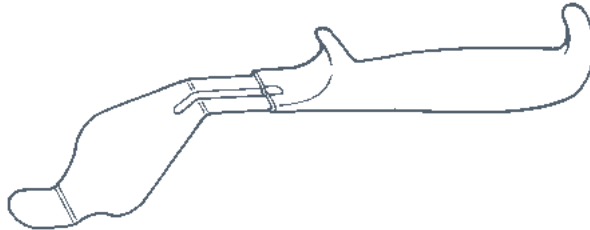

### Charnley

curved blade  
6192/05 220mm



### Fagge

6193/05 275mm



### Lane

heavy, solid handle  
6195/05 355mm



### Lane

ring handle  
6196/05 265mm



### Lane

serrated end  
6197/05 260mm



### Murphy Skid

6200/05 330mm



### Trethowan

ring handle  
6205/05 215mm







## BURS

### Paton



155mm

6290/05 3.5mm diameter

6290/10 4.5mm diameter

6290/15 5.0mm diameter

## CHISELS

### Capener



tufinol handle, length 250mm

6305/05 10mm

6305/10 12mm

6305/15 15mm

6305/20 20mm

6305/25 25mm

6305/30 30mm

6305/95 set of 6

### Smith Petersen



length 200mm

6320/05 6mm

6320/10 10mm

6320/15 13mm

6320/20 15mm

6320/25 20mm

6320/30 25mm

6320/35 30mm

### Swedish



length 200mm

6325/03 6mm

6325/05 10mm

6325/08 13mm

6325/10 15mm

6325/15 20mm

6325/20 25mm

6325/25 30mm



## DISSECTING FORCEPS

### Jackson Burrows

serrated, 1/2 teeth  
6330/25 140mm



### Jackson Burrows

with tongue and groove in jaw  
6330/50 140mm



## ELEVATORS

### Bristow

sharp  
6335/05 230mm



### Cobb

periosteal  
6340/05 200mm



### Spinal

305mm  
6345/05 18mm wide



## FILES

### Bone Rasp/File

combined  
6350/05 220mm



### Tubby

6355/05 305mm





## GOUGES

### Smith-Petersen



straight, length 200mm

6375/05 10mm

6375/10 15mm

6375/15 20mm

6375/20 25mm

### Swedish



straight, length 200mm

6380/03 6mm

6380/05 10mm

6380/08 13mm

6380/10 15mm

6380/15 20mm

6380/20 25mm

6380/25 30mm

### Tufnol Handle



straight, length 230mm

6385/05 10mm

6385/10 15mm

6385/15 20mm

6385/20 25mm

6385/25 30mm

## HAND DRILLS

### Pistol Grip

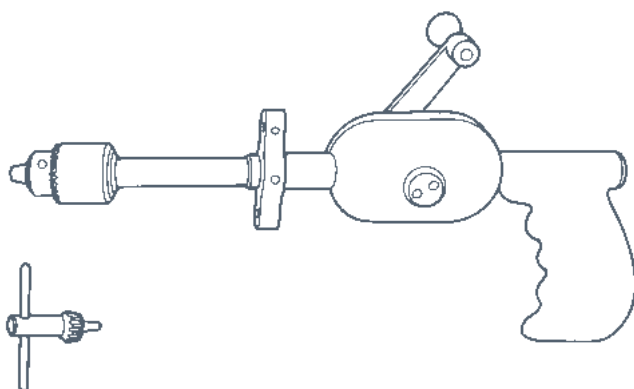

with Jacobs chuck and key

6395/05 complete

6395/10 Jacobs chuck key



## HAND DRILLS

### Ralk

complete with chuck  
6400/05 opens to 6.35mm

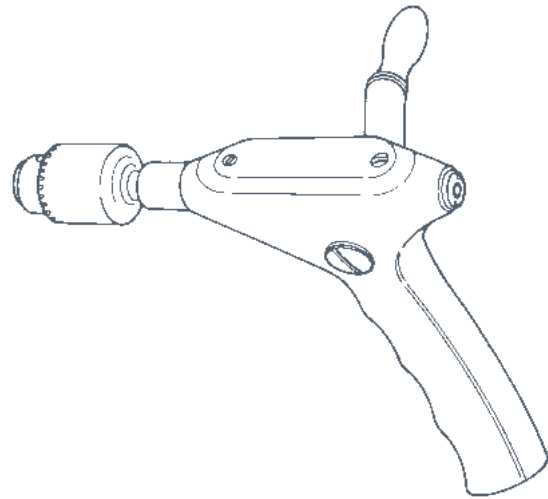

## HAND SPLINT

### Lead

6410/05 adult, 370mm x 310mm  
6410/10 child, 275mm x 160mm

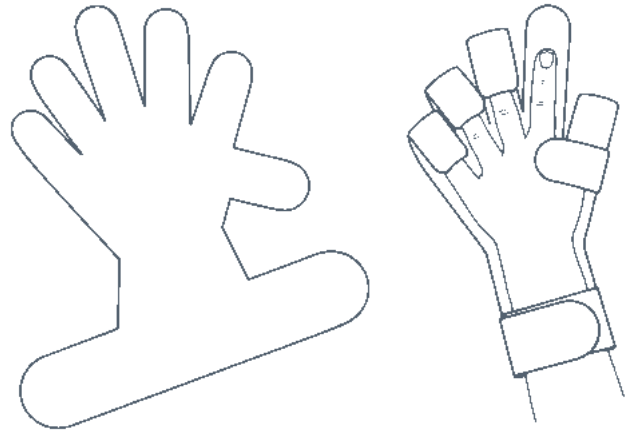

## KNIVES

### Adams Tenotomy

6450/05 fig 1, 145mm



### Adams Tenotomy

6450/10 fig 2, 140mm



### Adams Tenotomy

6450/15 fig 3, 140mm





## KNIVES



### Adams Tenotomy

6450/20 fig 4, 135mm



### Guy's Tenotomy

6455/05 140mm



### Jones Tenotomy

6460/05 135mm



### Monro Menisectomy

6470/05 175mm



### Parker Tenotomy

6475/05 fig 1, 13mm blade

6475/10 fig 2, 20mm blade

6475/15 fig 3, 13mm blade

6475/20 fig 4, 15mm blade



### Smillie Menisectomy

6480/25 straight, 175mm



### Smillie Menisectomy

6480/50 curved to left, 175mm



### Smillie Menisectomy

6480/75 curved to right, 175mm



## KNIVES

### Tenotomy

blunt

6485/25 30mm blade



### Tenotomy

sharp

6485/50 30mm blade



### Tubby Tenotomy

6490/05 135mm



## MALLETS

### Hajek

220mm, 27mm diameter

6510/05 140grms

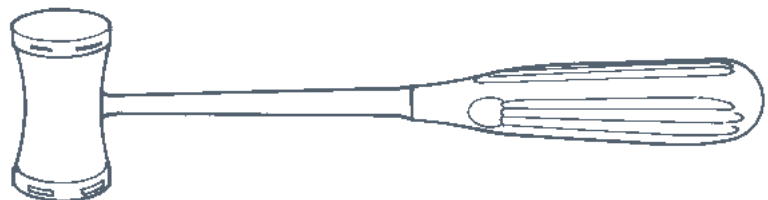

### Heath

copper head, electro plated

6515/05 18oz

6515/10 28oz

6515/15 32oz

6515/20 36oz

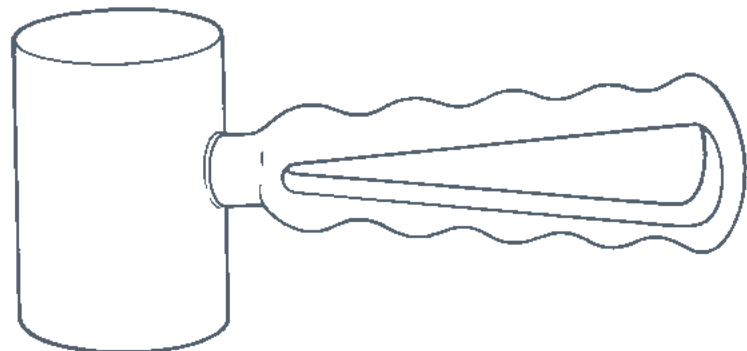



## MALLETS

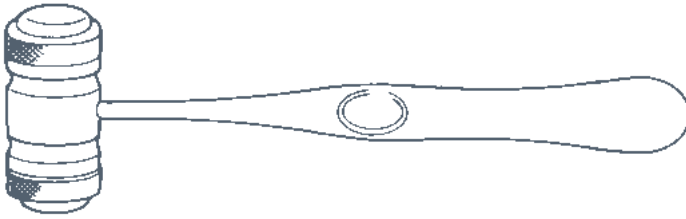

### Mead

170mm, 26mm diameter, with interchangeable faces

6520/05 320grms



### Stainless Steel

6525/05 8oz

## OSTEOTOMES

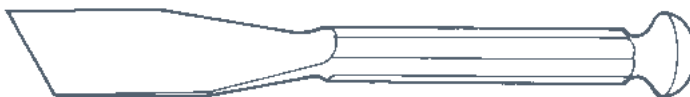

### Albee

length 190mm

6585/05 38mm

6585/10 50mm



### Capener

straight, tufnol handle, 250mm

6590/05 10mm

6590/10 12mm

6590/15 15mm

6590/20 20mm

6590/25 25mm

6590/30 30mm

6590/95 set of 6



## OSTEOTOMES

### Capener

curved, tufnol handle, 250mm

6595/05 10mm

6595/10 12mm

6595/15 15mm

6595/20 20mm

6595/25 25mm

6595/30 30mm

6595/95 set of 6



### Smith-Petersen

straight, 200mm

6600/05 10mm

6600/10 15mm

6600/15 20mm

6600/20 25mm

6600/25 30mm



### Smith-Petersen

curved, 200mm

6601/05 10mm

6601/10 15mm

6601/15 20mm

6601/20 25mm

6601/25 30mm



### Swedish

straight, 200mm

6605/03 6mm

6605/05 10mm

6605/08 13mm

6605/10 15mm

6605/15 20mm

6605/20 25mm

6605/25 30mm







## PIN INTRODUCER

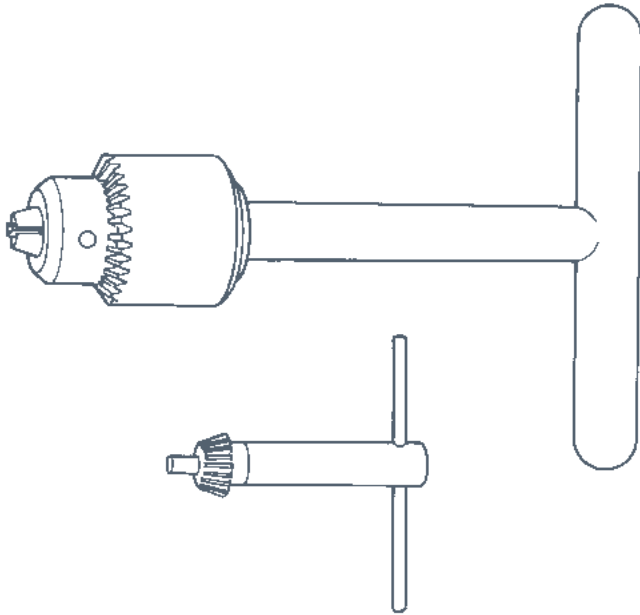

### Steinmann

complete with Jacobs chuck and key

6615/05 140mm

## PLATE BENDER



### Lane

6618/05 2 required in use

## PUNCHES

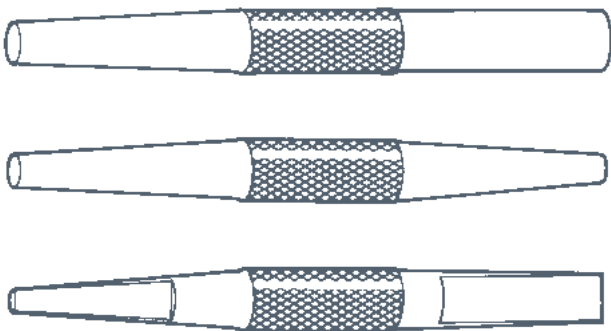

### McGoey

double ended

6640/05 fig 1, 19mm x 13mm

6640/10 fig 2, 10mm x 6mm

6640/15 fig 3, 13mm x 6mm

## RASPATORIES



### St Thomas

Length 180mm

6658/25 pointed

6658/50 round



## RASPS

### Putti

flat both ends  
6685/25 270mm



### Putti

rounded one end  
6685/50 300mm



## RETRACTORS

### Charnley

6688/05 215mm, 50mm x 6mm blade

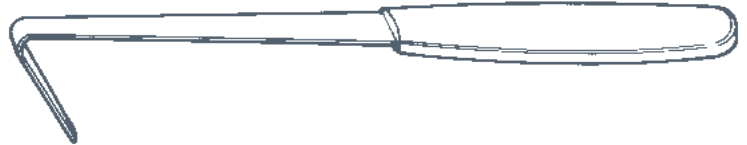

### Charnley Initial Incision

6690/05 305mm

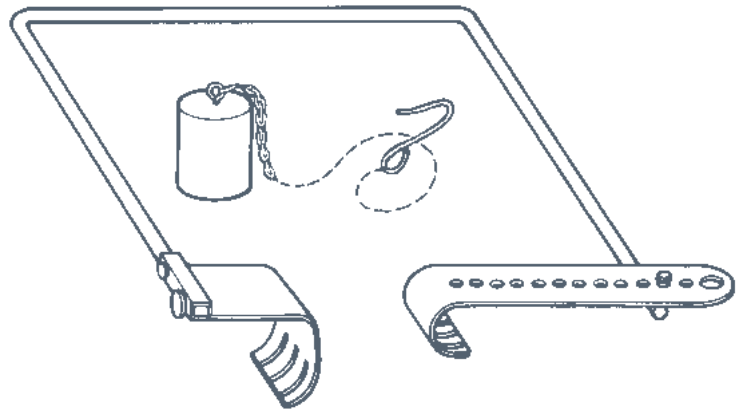

### Hohmann-Muller Spike

6695/05 8mm  
6695/10 18mm  
6695/15 43mm  
6695/20 70mm

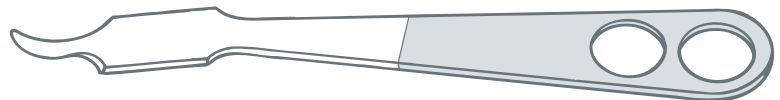



## RETRACTORS

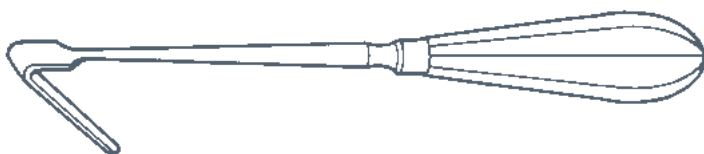

### Jackson Burrows

broad, angled  
6700/25 220mm

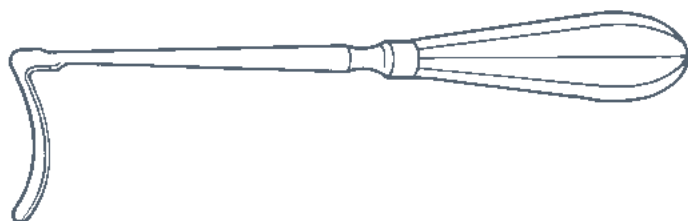

### Jackson Burrows

narrow, curved  
6700/50 220mm



### Smillie Hook

angled, 145mm  
6708/05 32mm x 19mm blade



### Smillie Hook

angled, 145mm  
6708/10 41mm x 19mm blade

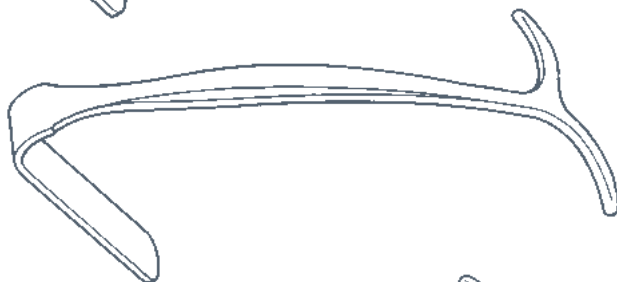

### Smillie Hook

angled, 145mm  
6708/15 57mm x 19mm blade

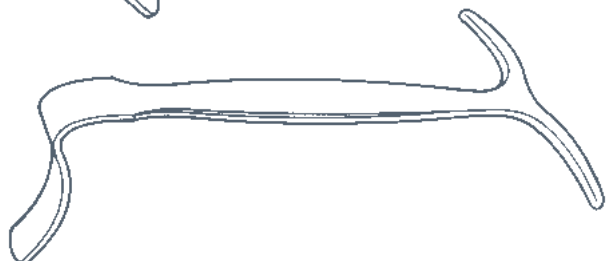

### Smillie Hook

right angled, curved, 145mm  
6709/05 10mm blade

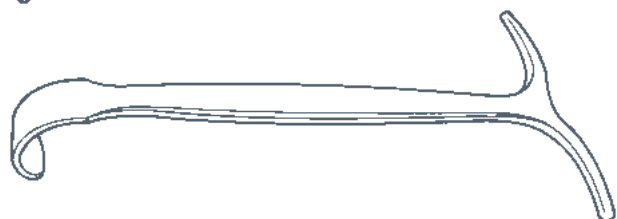

### Smillie Hook

set of 2  
6710/05 145mm



## RETRACTORS, SELF RETAINING

### Jackson Burrows

6715/05 175mm

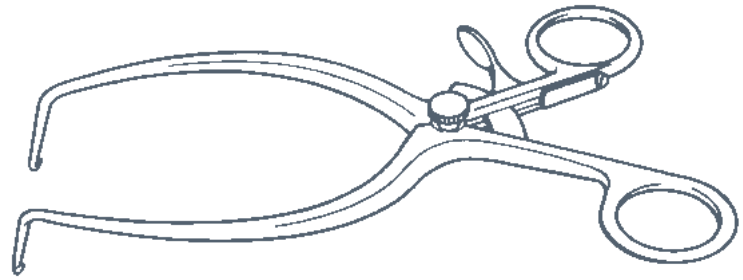

## RONGEURS

### Jansen

curved, compound action

6720/05 180mm

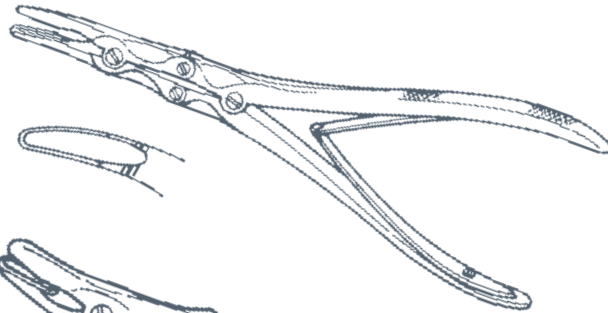

### Leksell

compound action

6725/05 230mm, 4mm jaw

6725/10 230mm, 6mm jaw

6725/15 230mm, 8mm jaw



### Lempert

straight

6730/10 190mm

curved

6731/05 160mm

6731/10 190mm

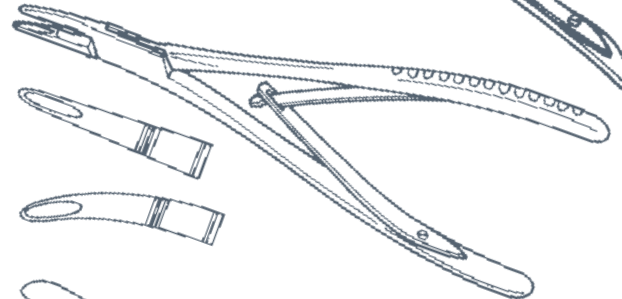

### Luer

straight, large

6735/25 170mm

curved, large

6735/50 170mm

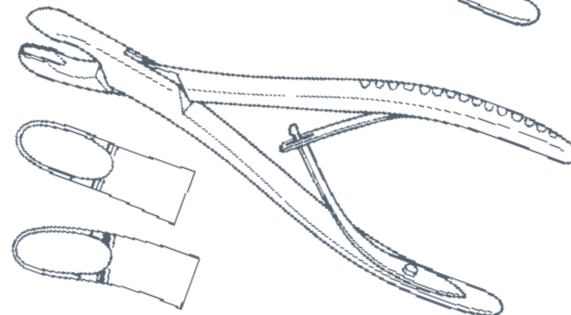

### Luer

curved, small

6736/05 150mm

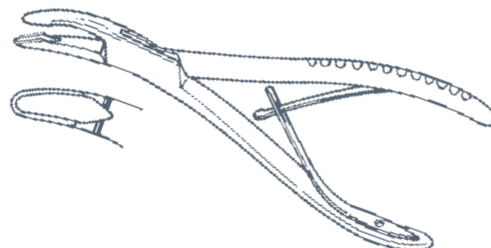



## RUGINES

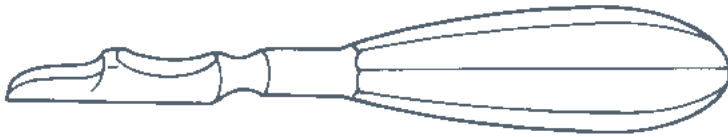

### Farabeuf

straight, hollow handle  
6740/25 160mm

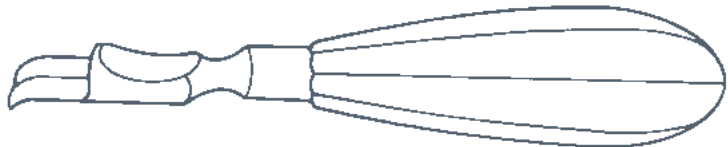

### Farabeuf

curved, hollow handle  
6740/50 160mm



### Farabeuf

straight, flat handle  
6741/25 150mm



### Farabeuf

curved, flat handle  
6741/50 150mm

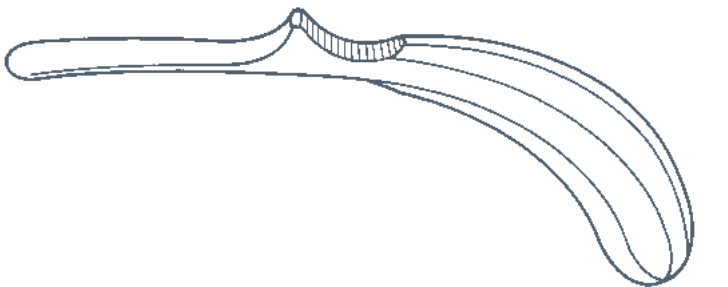

### Jones

pistol handle, fan shape  
6745/05 185mm

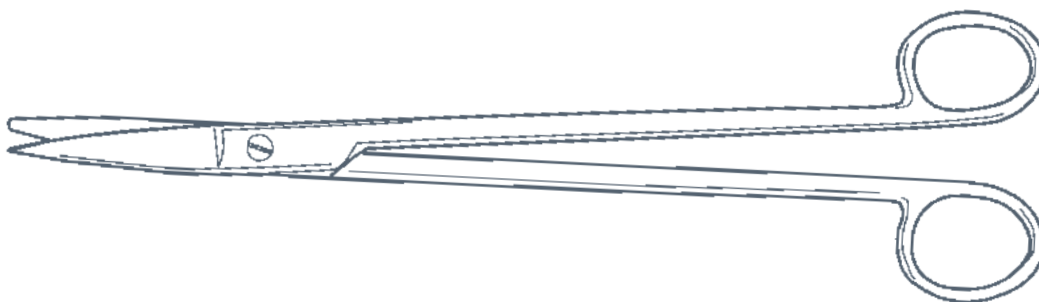

### Capsulotomy

angled  
6800/05 250mm

## SCISSORS



## SPRING CLIP

**Serrated**

6820/05 65mm width of jaws

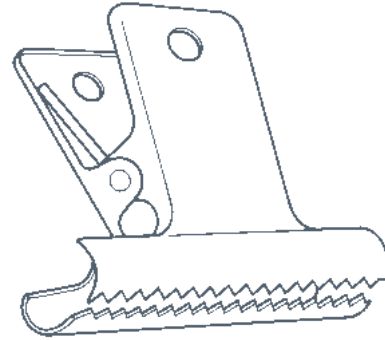

## STAPLE INSTRUMENTS

**Blount**

driver for large, small and wide staples

6825/05 160mm

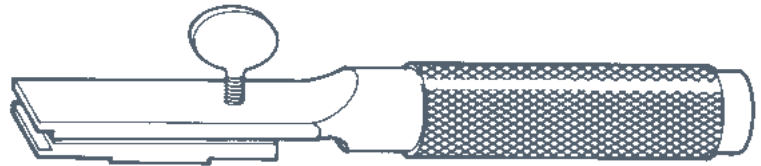

**Blount**

remover

6825/10 150mm



**Blount**

set

6825/15 165mm



**Blount**

starter, 160mm

6825/20 for 16mm staples

6825/25 for 22mm staples



## STIRRUPS

**Bohler**

rotating with swivel fixation pieces, suitable for Steinmann pins

6835/05 small, 100mm x 90mm

6835/10 medium, 165mm x 115mm

6835/15 large, 240mm x 150mm

**Bohler**

pin mount, for 4mm and 6mm pins

6836/05 22mm

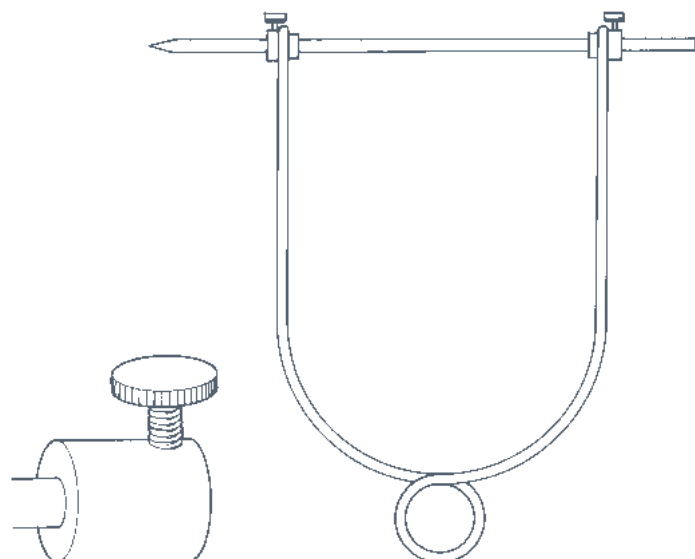



## SUTURE FORCEPS

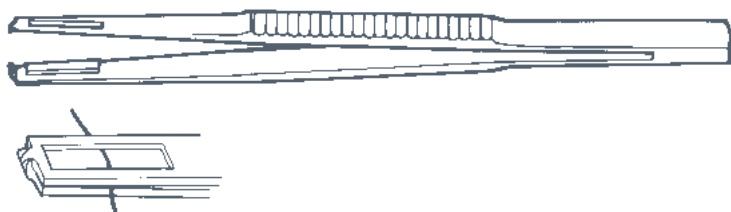

### Charnley

slotted, 1/2 teeth

6850/05 145mm

6850/10 180mm

## WIRE INSTRUMENTS



### Handle

with chuck

6895/05 100mm



### Loute

tightener

6900/05 210mm

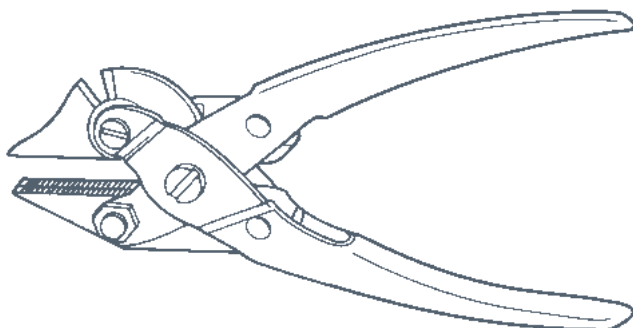

### Pliers

stainless steel with hammer end and side cutters,  
made in Pakistan

6905/05 160mm

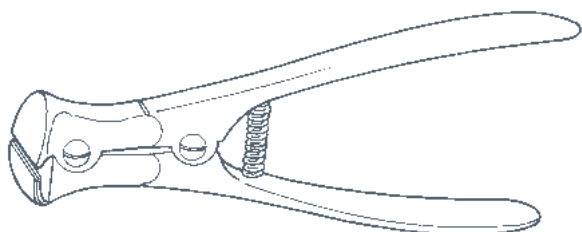

### Pliers

double action, small, to cut 1.5mm hard wire or  
2.0mm soft

6915/05 150mm

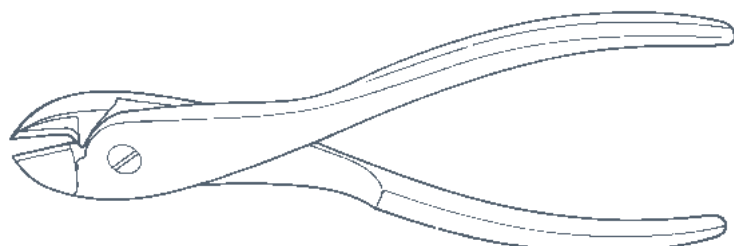

### Pliers

tungsten carbide, to cut 1.5mm hard wire or  
2.5mm soft

6920/05 185mm







## ARTERY FORCEPS

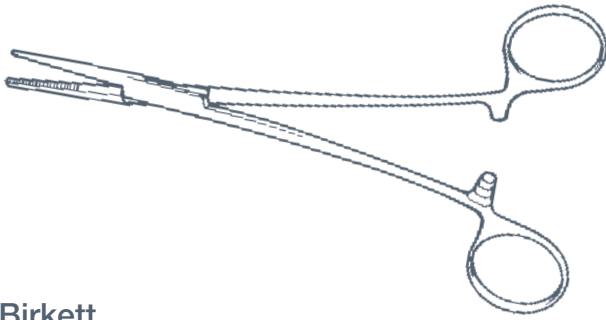

### Birkett

straight

7015/05 180mm

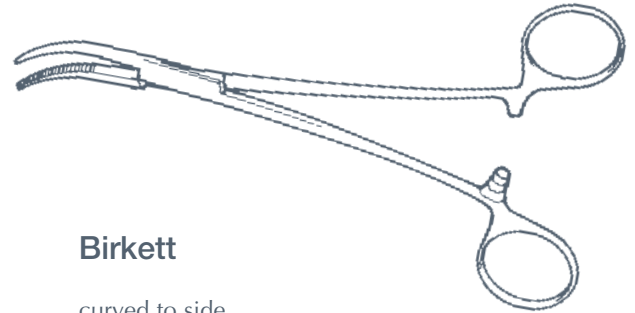

### Birkett

curved to side

7015/10 180mm

curved on flat

7015/15 180mm

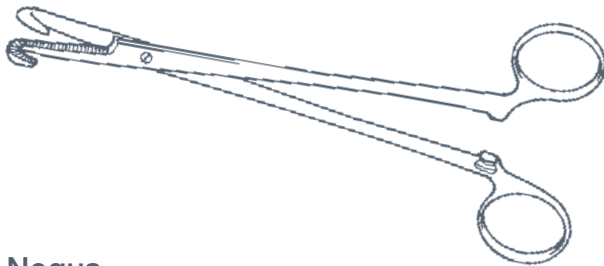

### Negus

small curve

screw joint

7018/05 180mm



large curve

screw joint

7018/10 180mm

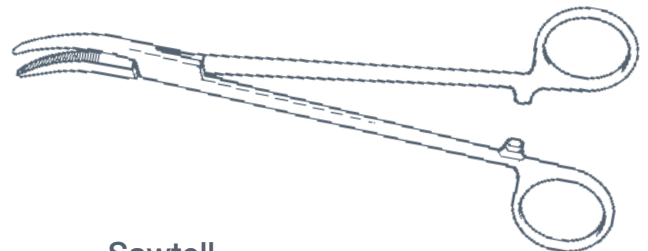

### Sawtell

curved on flat

7021/05 180mm

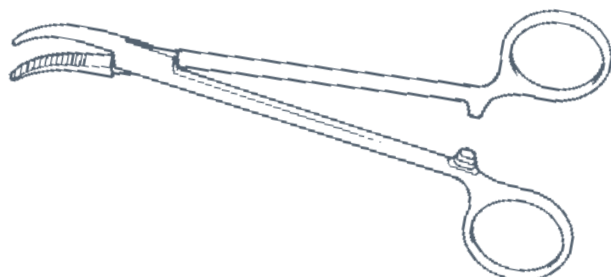

### Schnidt

curved on flat

7024/05 180mm

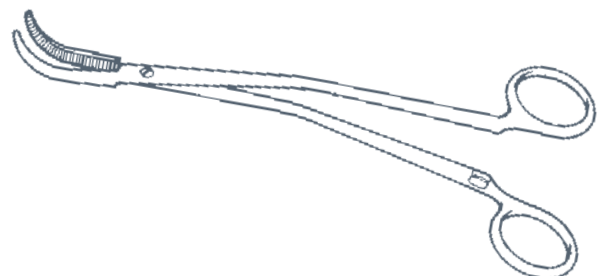

### Wilson

curved on flat, angle shaft,  
screw joint

7030/05 190mm





## AURAL FORCEPS



### Cawthorne

crocodile, black finish, extra fine with smooth jaws  
70mm effective length  
7038/05



### Fuller

crocodile, black finish, for introducing teflon pistons  
65mm effective length  
7041/05

### Hartmann

crocodile, black finish, extra fine with serrated jaws  
70mm effective length  
7044/25

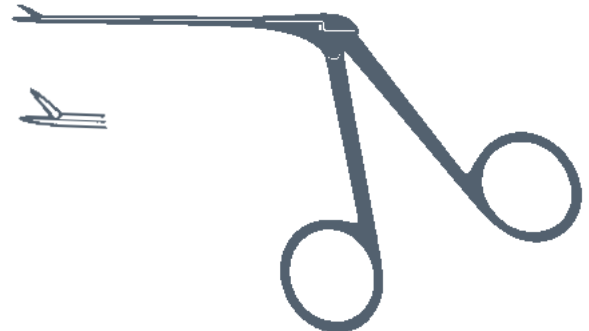

### Hartmann

crocodile, satin finish, serrated jaws  
75mm effective length  
7044/05



crocodile, satin finish, fine tenaculum jaws  
75mm effective length  
7044/10



crocodile, satin finish, round cutting jaws  
75mm effective length  
7044/15



crocodile, satin finish, Grunwald Punch Action jaws  
75mm effective length  
7044/20

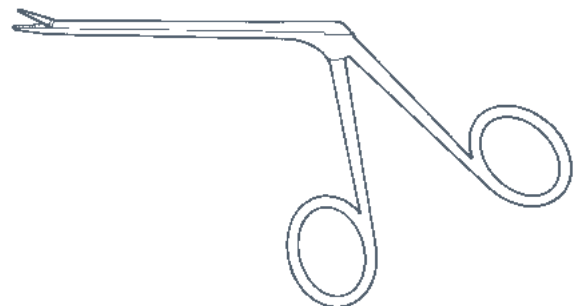



## AURAL FORCEPS

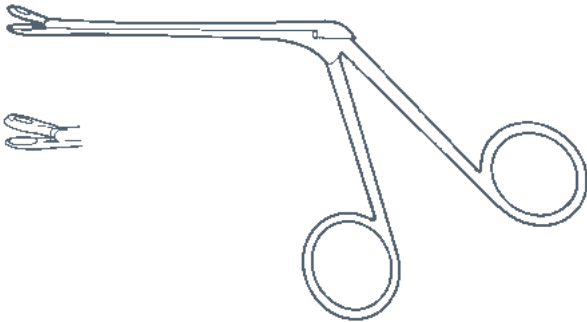

### Henckel

crocodile, satin finish, scoop blades,  
75mm effective length

7050/05

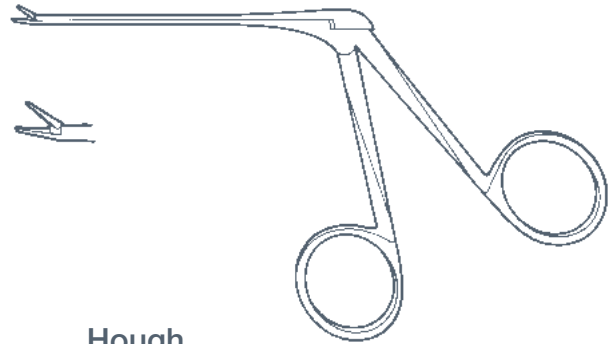

### Hough

crocodile, satin finish, serrated jaws,  
70mm effective length

7056/05

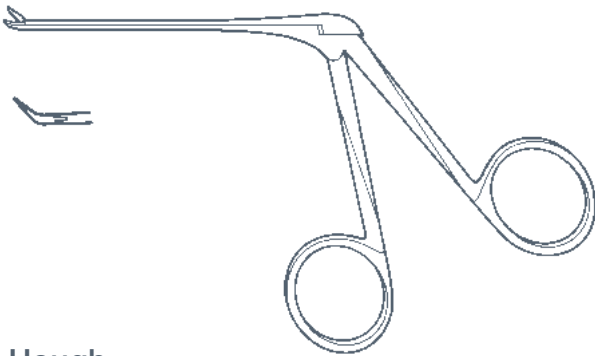

### Hough

crocodile, satin finish, serrated jaws angled to right  
70mm effective length

7056/10

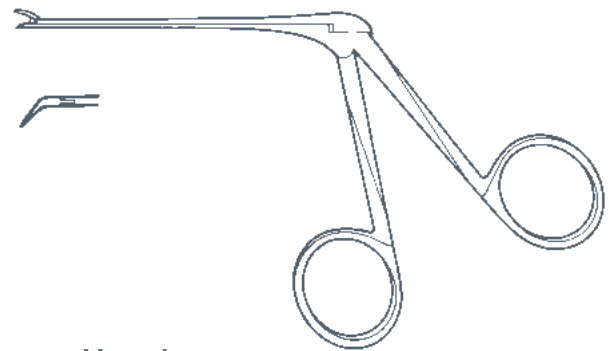

### Hough

crocodile, satin finish, serrated jaws angled to left  
70mm effective length

7056/15

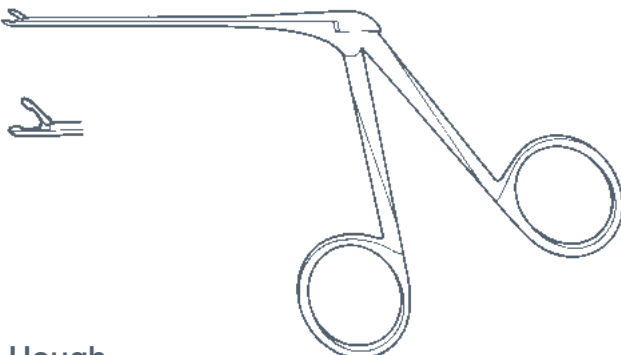

### Hough

crocodile, satin finish, oval cup jaws  
70mm effective length

7056/20

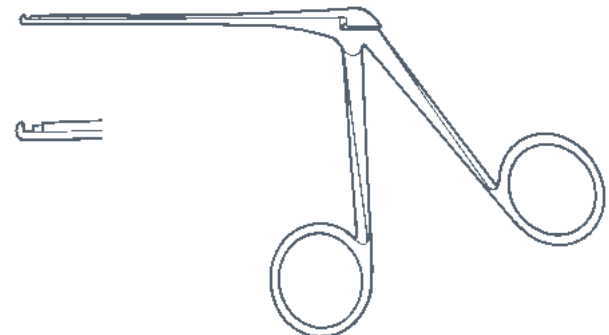

### House-Dieter Malleus

fine, satin finish, 75mm effective length

7059/05



## AURAL FORCEPS

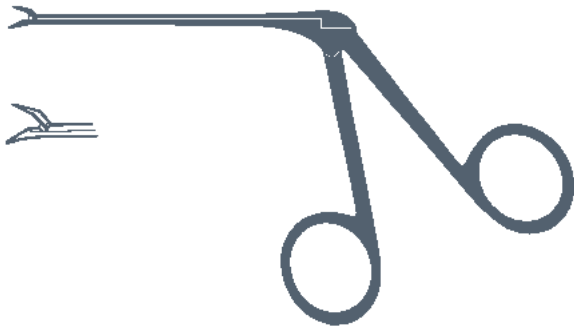

### McGee

crocodile, black finish, wire closing  
70mm effective length  
7064/05



### Ormerod

crocodile, black finish, extra fine serrated jaws,  
angled upwards 70mm effective length  
7065/05



### Ormerod

crocodile, black finish, fine circular cup jaws  
70mm effective length  
7065/10



### Ormerod

crocodile, black finish, fine elongated cup jaws  
70mm effective length  
7065/15

### Shea

crocodile, black finish, oval cup jaws

- 7071/05 straight, 70mm effective length
- 7071/10 curved to the left, 70mm effective length
- 7071/15 curved to the right, 70mm effective length
- 7071/20 curved upwards, 70mm effective length

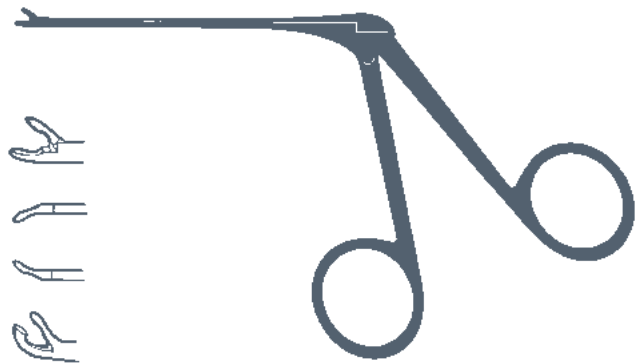



## AURAL FORCEPS

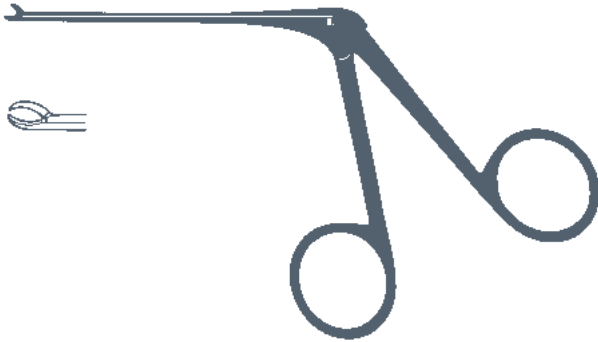

### Tabb Crura

crocodile, black finish  
75mm effective length  
7077/05

## AURAL DRESSING FORCEPS

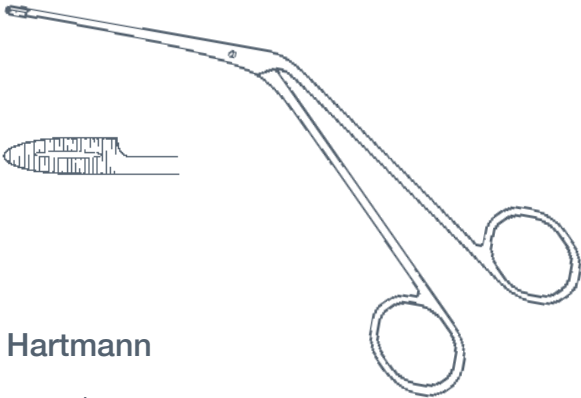

### Hartmann

serrated, screw joint 140mm  
7080/05

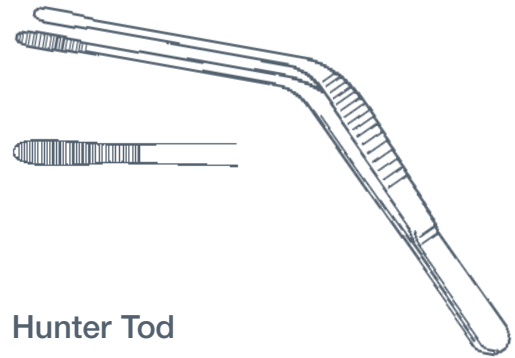

### Hunter Tod

serrated ends 110mm  
7081/05

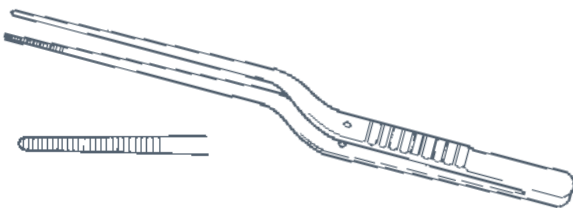

### Lucae

serrated ends 150mm  
7082/05

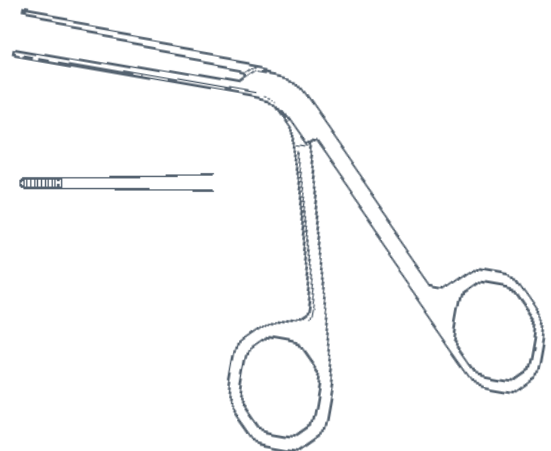

### Tilley

serrated ends 145mm  
7086/05



## AURAL DRESSING FORCEPS

### Wilde

1/2 teeth 135mm  
7088/05

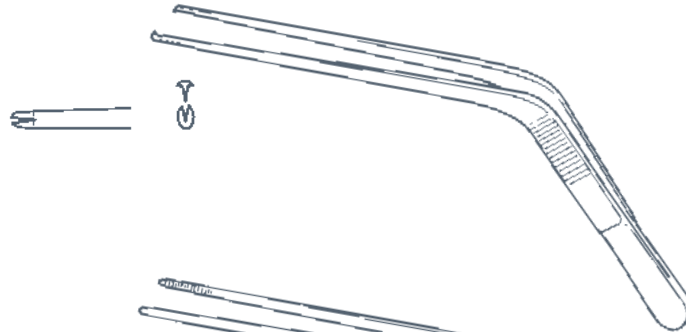

### Wilde

serrated ends 135mm  
7088/10

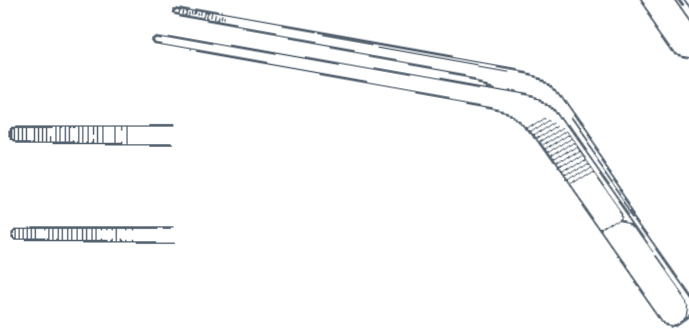

extra fine serrated ends 135mm  
7088/20



## AURAL INSTRUMENTS



### Cawthorne

Hook, black finish, 165mm  
7096/05 No. 1, slight curve



Hook, black finish, 165mm  
7096/30 No. 6,  
90° angle, 1mm



Hook, black finish, 165mm  
7096/10 No. 2, medium curve



Hook, black finish, 165mm  
7096/35 No. 7, retrograde



Hook, black finish, 165mm  
7096/15 No. 3, full curve



Hook, black finish, 165mm  
7096/40 No. 8,  
45° angle, 0.5mm



Hook, black finish, 165mm  
7096/20 No. 4, double curve



Hook, black finish, 165mm  
7096/45 No. 9, straight



Hook, black finish, 165mm  
7096/25 No. 5, 90° angle, 0.5mm



7096/95 set of 9 instruments



## AURAL INSTRUMENTS

### Rosen

Curette No. 5, black finish  
7105/05 160mm



Fenestrator, cross chequered  
handle, black finish  
7105/30 160mm

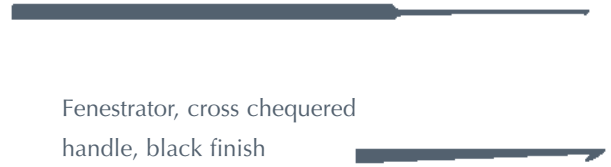

Curette No. 6, black finish  
7105/10 160mm



Knife No. 1, black finish  
7105/35 160mm

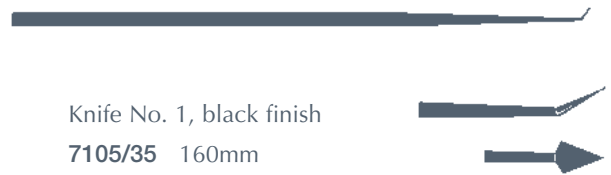

Elevator No. 2, bayonet shaped,  
broad, black finish  
7105/15 190mm



Mobiliser No. 8,  
black finish  
7105/40 160mm

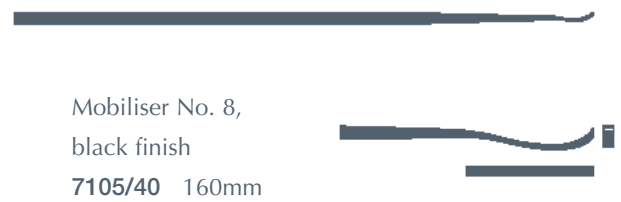

Elevator No. 3, bayonet shaped,  
narrow, black finish  
7105/20 190mm



Mobiliser No. 9,  
black finish  
7105/45 160mm

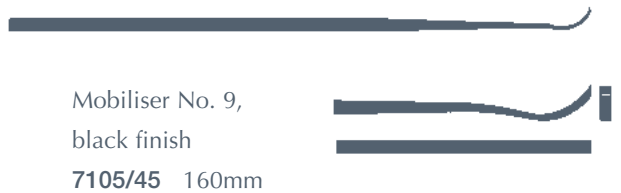

Elevator No. 4, black finish  
7105/25 160mm



Probe, No. 7, footplate, black finish  
7105/50 160mm

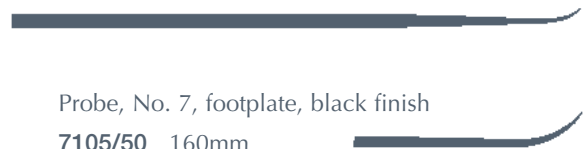

Scoop No. 11, oval, straight, black finish, 160mm

- 7105/55 size 000
- 7105/60 size 00
- 7105/65 size 0
- 7105/70 size 1





## AURAL INSTRUMENTS



### Schuknecht

Micro-Hook, black finish, 160mm  
7108/05 upward 4mm



Micro-Hook, black finish, 160mm  
7108/10 downward 4mm



Hook, black finish, 160mm  
7108/15 upward 7mm



Hook, black finish, 160mm  
7108/20 downward 7mm



Elevator, black finish, 160mm  
7108/25 oval window

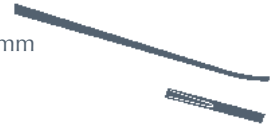

Hook, black finish, 160mm  
7108/30 right angled upward



Pick, black finish, 160mm  
7108/35 straight



Spatula, black finish, 160mm  
7108/40 straight



7108/95 set of 8 instruments

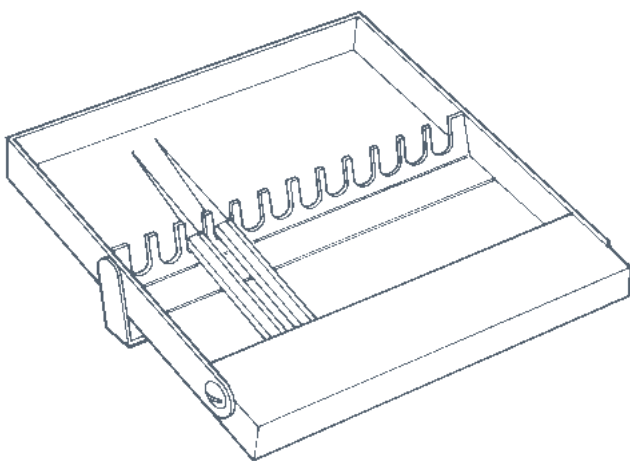

### Tray

racked to autoclave and carry straight instruments

7109/05 8 instrument

7109/10 12 instrument

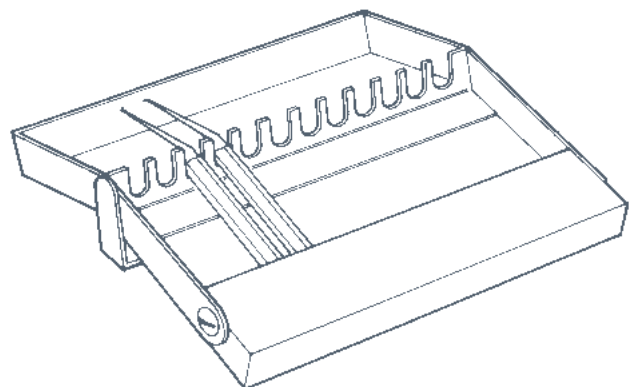

### Tray

racked to autoclave and carry angled instruments

7109/55 8 instrument

7109/60 12 instrument





## AURAL SNARE

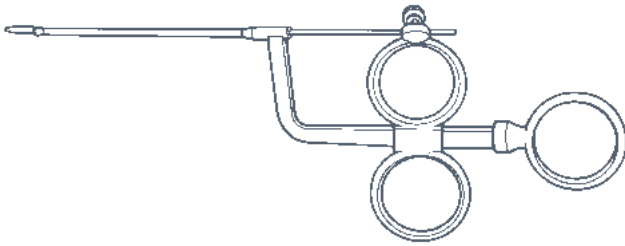

### Glegg

self-forming 165mm

7111/05

spare wire 36swg

7111/50

## AURAL SPECULA

### Rosen

unslotted, round ends, black finish, 35mm

7121/05 3mm diameter

7121/10 4mm diameter

7121/15 5mm diameter

7121/20 6mm diameter

7121/25 7mm diameter

7121/95 set of 5

### Siegle (Peters)

Otoscope with 5 ear specula, rubber tube and bulb

7127/05 complete

7127/55 spare speculum 6.5mm

7127/60 spare speculum 7.0mm

7127/65 spare speculum 8.0mm

7127/70 spare speculum 9.0mm

7127/75 spare speculum 10.0mm

### Tumarkin

tapered slot

7138/05 size 0, 4.5mm

7138/10 size 1, 6.5mm

7138/15 size 2, 7.0mm

7138/20 size 3, 7.5mm

7138/25 size 4, 8.0mm

7138/30 size 5, 8.5mm

7138/35 size 6, 9.0mm

7138/40 size 7, 11.0mm

7138/95 set of 8

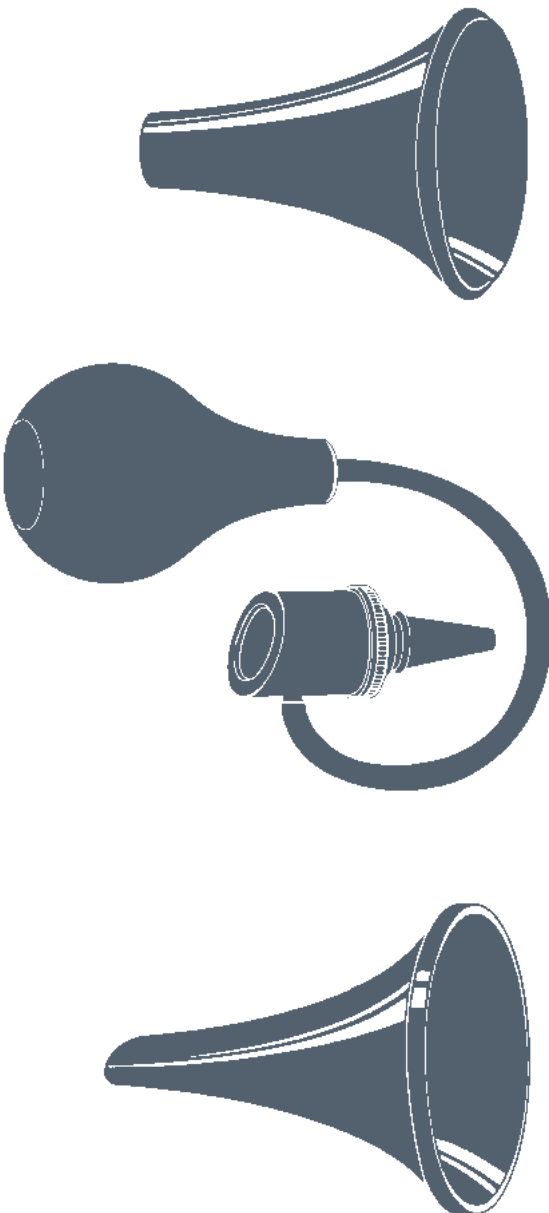



## BIOPSY FORCEPS

### Chevalier Jackson

basket jaw with round end

7145/05 280mm effective length

7145/10 550mm effective length



### Chevalier Jackson

basket lower jaw

7147/05 350mm effective length

7147/10 400mm effective length

7147/15 450mm effective length

7147/20 500mm effective length

7147/25 550mm effective length

7147/30 600mm effective length



### Paterson

7150/05 200mm effective length

7150/10 250mm effective length

7150/15 300mm effective length

7150/20 350mm effective length

7150/25 400mm effective length

7150/30 450mm effective length

7150/35 500mm effective length

7150/40 550mm effective length

7150/45 600mm effective length

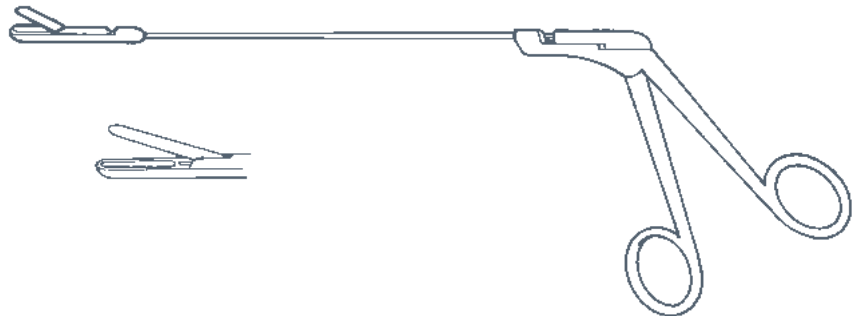

### Paterson

extra fine

7153/05 350mm effective length

7153/10 450mm effective length





## BIPOD

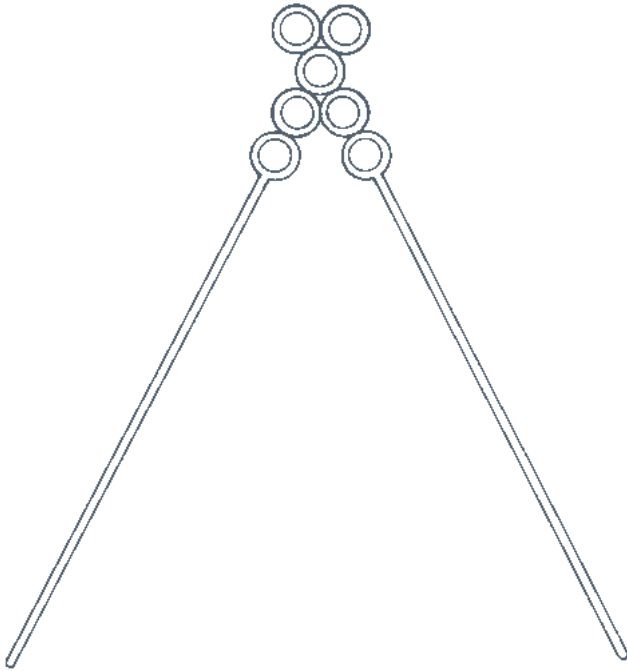

### Draffin

480mm  
7160/05



### Magauran Plate

to hold bipod  
7163/05

## BURS

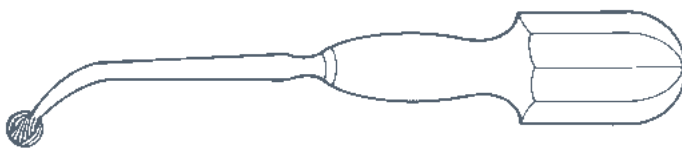

### Tilley

170mm  
7190/05 6mm diameter  
7190/10 7mm diameter  
7190/15 8mm diameter

## CATHETERS



### Woakes Eustachian

silver, luer, 140mm  
7215/05 7fg, 2.3mm  
7215/10 8fg, 2.7mm  
7215/15 9fg, 3.0mm  
7215/20 10fg, 3.3mm  
7215/25 11fg, 3.7mm



## CERUMEN HOOKS

### Cawthorne

145mm  
7230/05



### Formby

175mm  
7233/05



### Lucae

140mm  
7236/05 small  
7236/10 medium  
7236/15 large



### St. Barts

blunt 175mm  
7239/05



## CONCHOTOMES

### Hartmann

circular cutting, 100mm  
7245/05 5mm diameter  
7245/10 7mm diameter  
7245/15 9mm diameter  
7245/20 11mm diameter

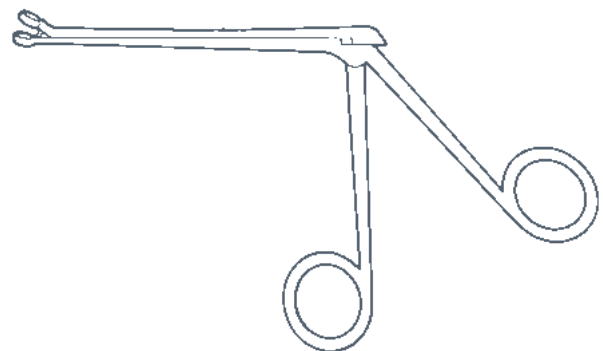



## CURETTES

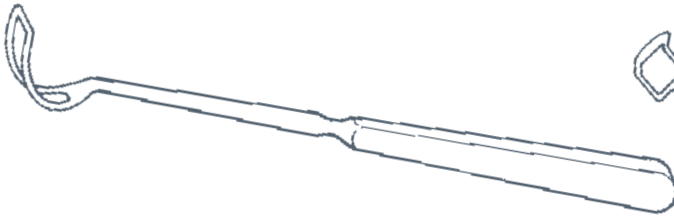

### Barnhill

length 215mm  
7253/05 10mm  
7253/10 14mm  
7253/15 16mm  
7253/20 18mm

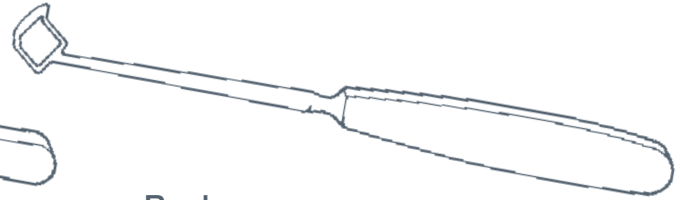

### Beckmann

length 215mm  
7256/05 8mm  
7256/10 10mm  
7256/15 12mm  
7256/20 14mm  
7256/25 16mm  
7256/30 18mm



### House

straight, double ended  
7262/05 180mm  
  
angled, double ended  
7262/10 180mm



### Mackie

length 195mm  
7265/05 6mm diameter  
7265/10 8mm diameter  
7265/15 9mm diameter

### St Clair Thompson

length 235mm  
7268/05 8mm  
7268/10 10mm  
7268/15 12mm  
7268/20 14mm  
7268/25 16mm  
7268/30 18mm

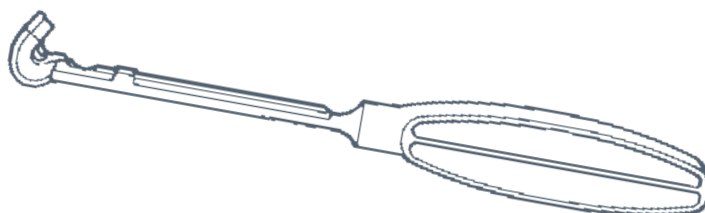



## DIATHERMY FORCEPS



### Remington Hobbs

insulated, serrated 250mm  
7320/25

insulated, 1/2 teeth 250mm  
7320/50

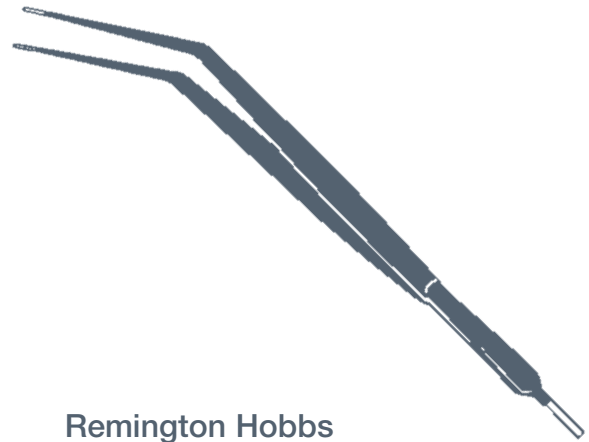

### Remington Hobbs

insulated, serrated, angled 250mm  
7320/75

## DISSECTORS

### Gwynne Evans

double ended, 195mm  
7325/05 6mm wide  
7325/10 8mm wide



### Hurd

double ended  
7328/05 195mm



### Mollison

double ended  
7331/05 210mm





## DISSECTORS

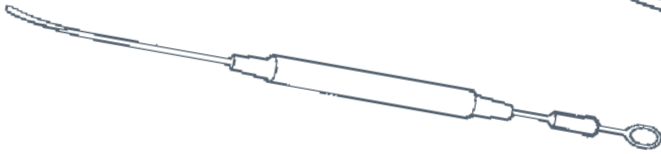

### Negus Aspirating

205mm  
7334/05

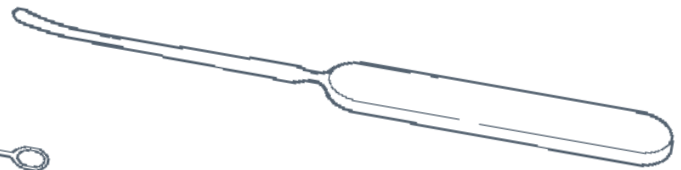

### St Clair Thompson

blunt 160mm  
7343/05  
  
sharp 160mm  
7343/10



### Syme

one blunt, one semi sharp end 180mm  
7346/05

## ELEVATORS



### Freer

double ended, separator and elevator 200mm  
7350/05

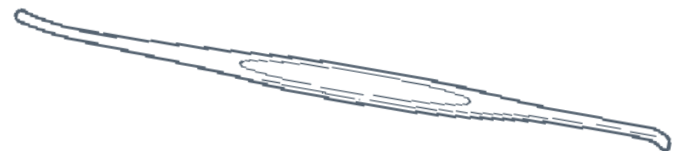

### Hill

double ended, curved to side 220mm  
7353/05



## GOUGES

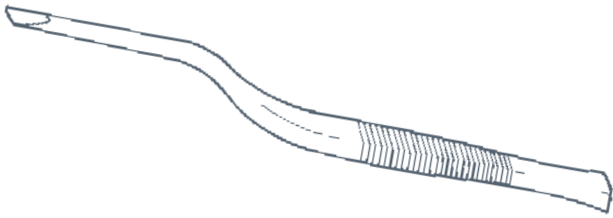

### Guy's

shallow groove length 125mm  
7370/05

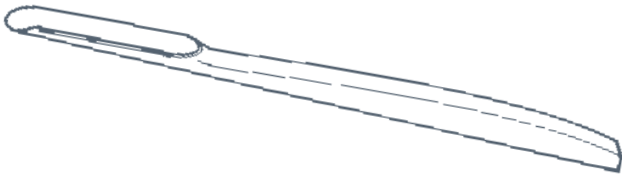

### Jenkins

length 140mm

7373/05 1mm

7373/10 2mm

7373/15 3mm

7373/20 4mm

7373/25 5mm

7373/30 6mm

7373/35 8mm

7373/40 10mm

7373/45 12mm

7373/50 14mm

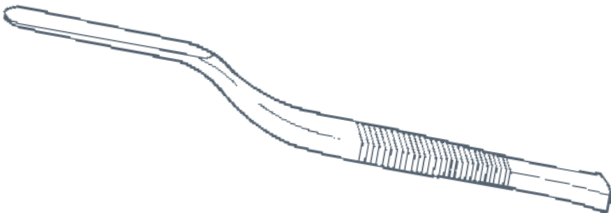

### Killian

length 125mm  
7376/05

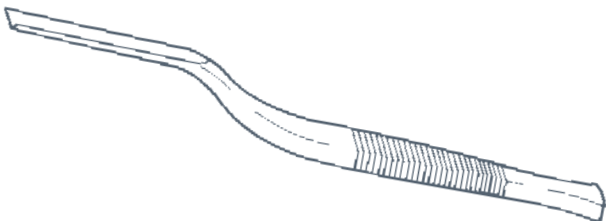

### Tilley

length 125mm  
7379/05





## KNOT TIER AND PUSHER



### Negus

7430/05 200mm

## LARYNGEAL FORCEPS



### Chevalier Jackson

alligator jaw

- 7435/05 300mm effective length
- 7435/10 350mm effective length
- 7435/15 400mm effective length
- 7435/20 450mm effective length
- 7435/25 550mm effective length

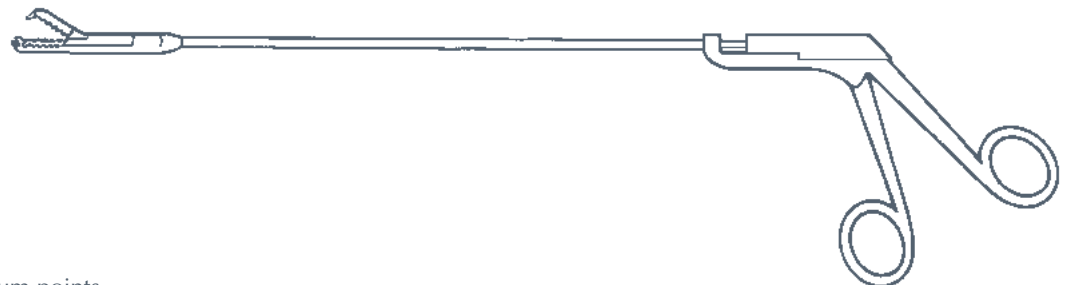
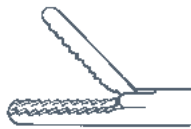

### Irwin Moore

alligator jaw, tenaculum points

- 7440/05 300mm effective length
- 7440/10 350mm effective length
- 7440/15 400mm effective length
- 7440/20 550mm effective length





## LARYNGEAL FORCEPS



### Micro

black finish 250mm

7441/05 straight oval cup jaw



7441/10 straight round cup jaw



7441/15 curved to left round cup jaw



7441/20 curved to right round cup jaw



7441/25 curved upwards round cup jaw



7441/55 straight serrated jaw



7441/30 straight scissor type jaw



7441/60 curved to right serrated jaw



7441/35 curved to right scissor type jaw



7441/65 curved to left serrated jaw



7441/40 curved to left scissor type jaw



7441/70 horizontal serrated jaw



7441/45 horizontal scissor type jaw



7441/75 straight blakesley jaw



7441/50 curved upwards scissor type jaw





## MIRRORS



### Handle, Laryngeal

for use with Laryngeal mirrors 95mm  
7515/05

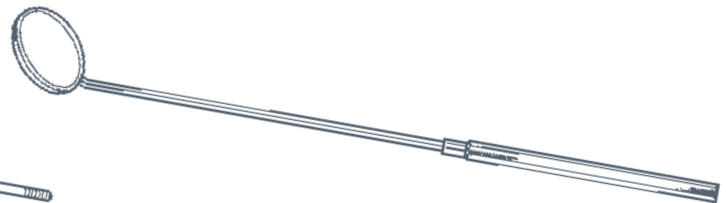

### Laryngeal

without handle, 130mm

- 7517/05 6mm diameter
- 7517/10 8mm diameter
- 7517/20 10mm diameter
- 7517/25 12mm diameter
- 7517/30 14mm diameter
- 7517/35 16mm diameter
- 7517/40 18mm diameter
- 7517/45 20mm diameter
- 7517/50 22mm diameter
- 7517/55 24mm diameter
- 7517/60 26mm diameter
- 7517/65 28mm diameter
- 7517/70 30mm diameter

### Laryngeal Mirror

complete with metal handle

- 7519/05 6mm diameter
- 7519/10 8mm diameter
- 7519/20 10mm diameter
- 7519/25 12mm diameter
- 7519/30 14mm diameter
- 7519/35 16mm diameter
- 7519/40 18mm diameter
- 7519/45 20mm diameter
- 7519/50 22mm diameter
- 7519/55 24mm diameter
- 7519/60 26mm diameter
- 7519/65 28mm diameter
- 7519/70 30mm diameter

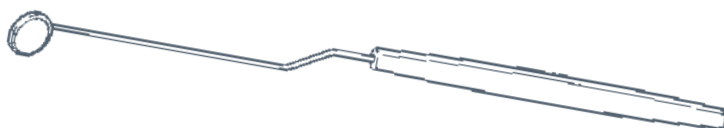

### St. Clair Thompson Rhinoscope

- 7525/05 size 6
- 7525/10 size 8
- 7525/15 size 10
- 7525/20 size 12
- 7525/25 size 14
- 7525/30 size 16



## MOUTH GAGS

### Doyen

- 7529/05 adult
- 7529/10 child

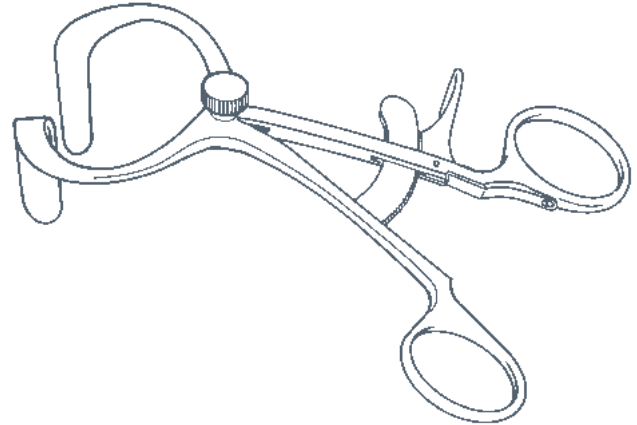

### Davis-Boyle

- frame only
- 7535/05 adult
- 7535/10 child

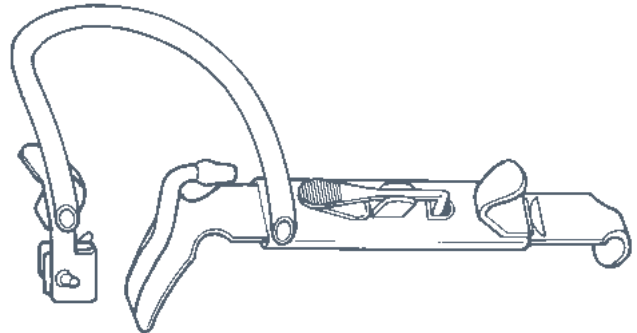

### Tongue Plates

- plain
- 7536/05 fig. 1 65mm
- 7536/10 fig. 2 75mm
- 7536/15 fig. 3 90mm
- 7536/20 fig. 4 100mm

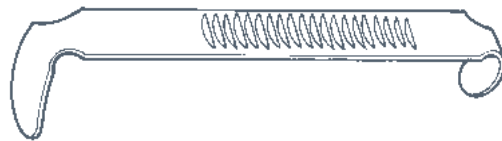

### Tongue Plates

- slotted
- 7537/05 fig. 1 65mm
- 7537/10 fig. 2 75mm
- 7537/15 fig. 3 90mm
- 7537/20 fig. 4 100mm
- 7537/25 fig. 5 115mm

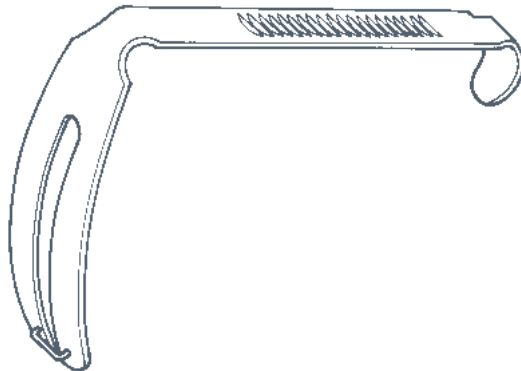

### Tongue Plates

- with anaesthetic tube
- 7540/05 fig. 1 65mm
- 7540/10 fig. 2 75mm
- 7540/15 fig. 3 90mm
- 7540/20 fig. 4 100mm
- 7540/25 fig. 5 115mm

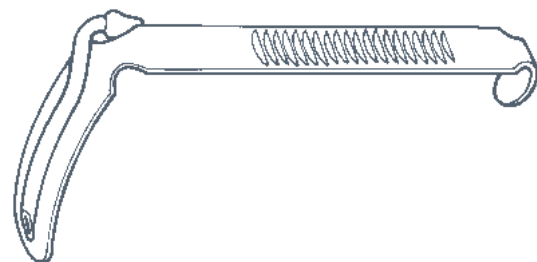



## MYRINGOTOMES



### Agnew

190mm  
7545/05



### Politzer

reversing into handle, adjustable 170mm  
7548/05



### Trautmann

downward cutting 175mm  
7551/25



### Trautmann

upward cutting 175mm  
7551/50

## NASAL FORCEPS

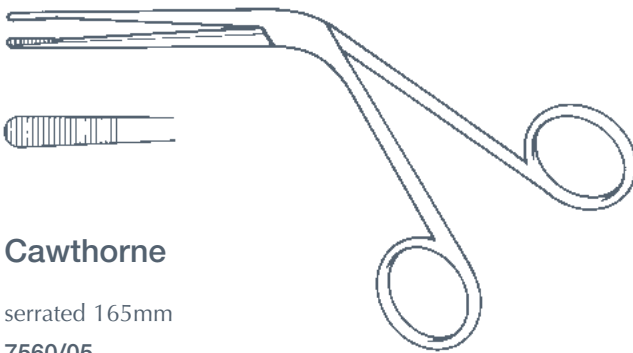

### Cawthorne

serrated 165mm  
7560/05

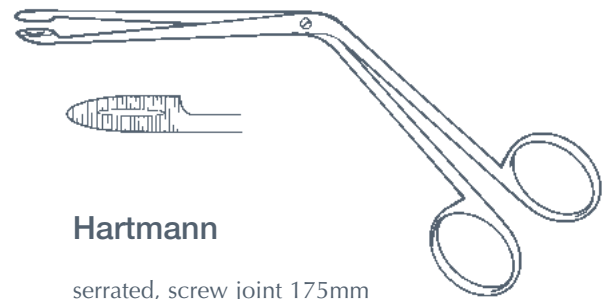

### Hartmann

serrated, screw joint 175mm  
7563/05

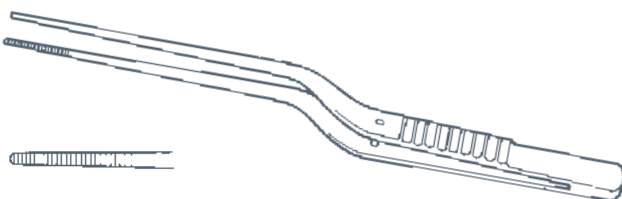

### Lucae

serrated 160mm  
7564/05

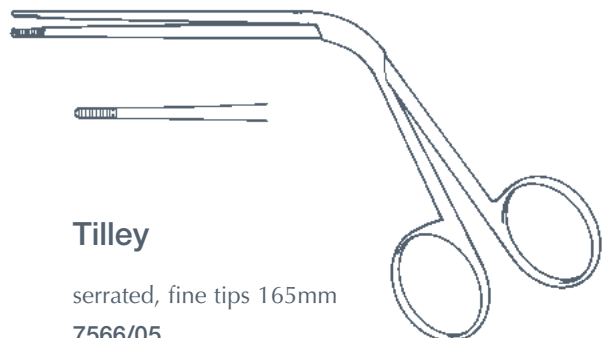

### Tilley

serrated, fine tips 165mm  
7566/05



## NASAL INSTRUMENTS



### Freer

Knife, rounded edge  
7580/05 190mm



Elevator, dull edge  
7580/25 190mm



Knife, flat rounded blade  
7580/10 190mm



Knife, curved to side  
7580/30 190mm



Knife, rounded blade  
curved on flat  
7580/15 190mm



Chisel  
7580/35 190mm



Elevator, sharp edge  
7580/20 190mm



### House Measuring Rods

black finish, 160mm  
7583/05 3.5mm



black finish, 160mm  
7583/15 4.5mm



black finish, 160mm  
7583/10 4.0mm



black finish, 160mm  
7583/20 5.0mm



### Hughes Stapes Mobiliser

black finish  
7586/05 165mm





## NASAL KNIVES

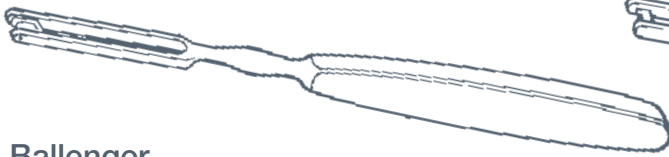

### Ballenger

straight, 200mm

7590/05 6mm wide

7590/10 8mm wide



### Ballenger

cranked, 195mm

7591/05 6mm wide

## NASAL RASP

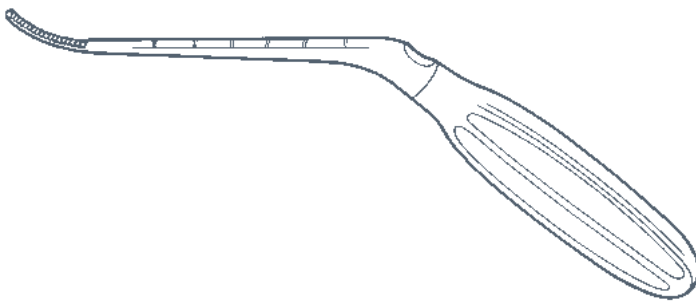

### Watson-Williams

rounded with convex blade,  
small 170mm

7605/05

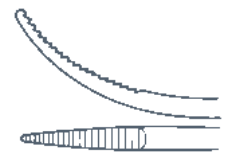

rounded with convex blade,  
large 170mm

7605/10

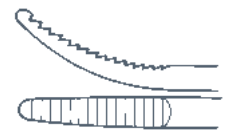

## NASAL SNARE

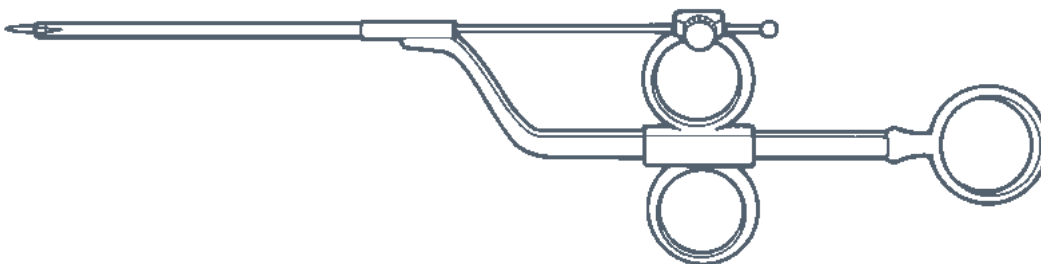

### Glegg

self looping 235mm

7610/05

spare wire 28swg

7610/50



## NASAL SNARE

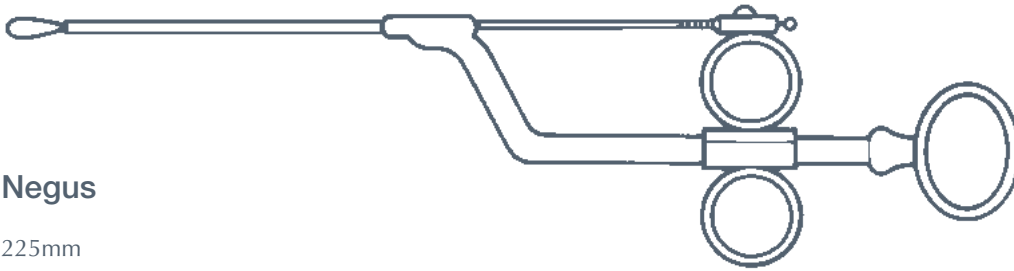

### Negus

225mm  
7613/05

## NASAL SPECULA

### Killian

plain

- 7623/05 blade 50mm
- 7623/10 blade 55mm
- 7623/15 blade 65mm
- 7623/20 blade 75mm
- 7623/25 blade 90mm

insulated

- 7626/03 blade 50mm
- 7626/05 blade 55mm
- 7626/08 blade 65mm
- 7626/10 blade 75mm
- 7626/15 blade 90mm

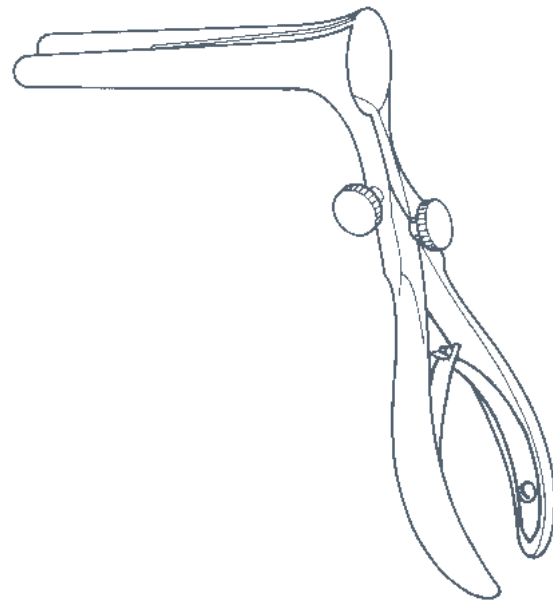

### St Clair Thompson

- 7629/05 blade 38mm
- 7629/10 blade 50mm
- 7629/15 blade 65mm
- 7629/20 blade 75mm
- 7629/95 set of 4

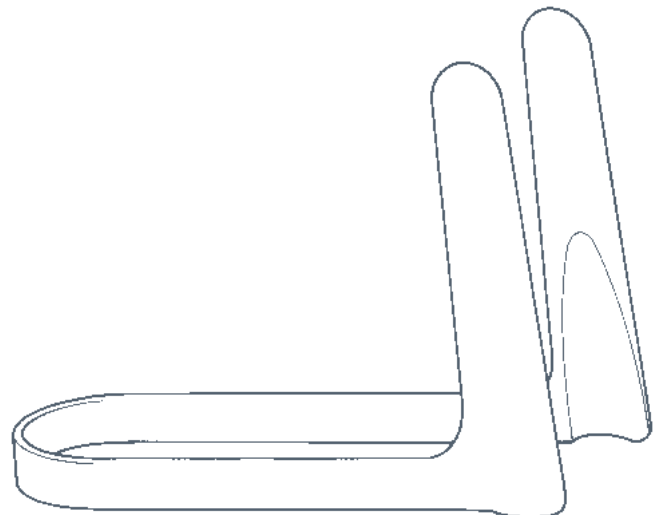





## NASAL SPECULA

### Thudichum

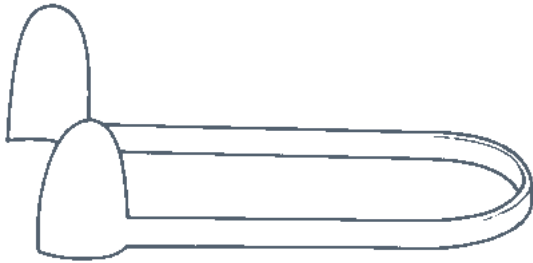

70mm		insulated, 70mm
<b>7632/05</b>	size 1	<b>7635/05</b> size 1
<b>7632/10</b>	size 2	<b>7635/10</b> size 2
<b>7632/15</b>	size 3	<b>7635/15</b> size 3
<b>7632/20</b>	size 4	<b>7635/20</b> size 4
<b>7632/25</b>	size 5	<b>7635/25</b> size 5
<b>7632/30</b>	size 6	<b>7635/30</b> size 6
<b>7632/35</b>	size 7	<b>7635/35</b> size 7
<b>7632/95</b>	set of 7	<b>7635/95</b> set of 7

## NIBBLING FORCEPS

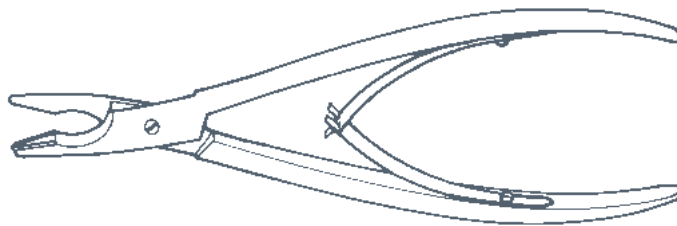

### Lempert

straight, screw joint  
**7640/05** 150mm, 2.5mm jaw

## NODULE FORCEPS



### Chevalier Jackson

upward cup  
**7645/05** 280mm effective length  
**7645/10** 350mm effective length  
**7645/15** 400mm effective length  
**7645/20** 500mm effective length  
**7645/25** 550mm effective length



## NOISE APPARATUS

**Barany**

7650/05

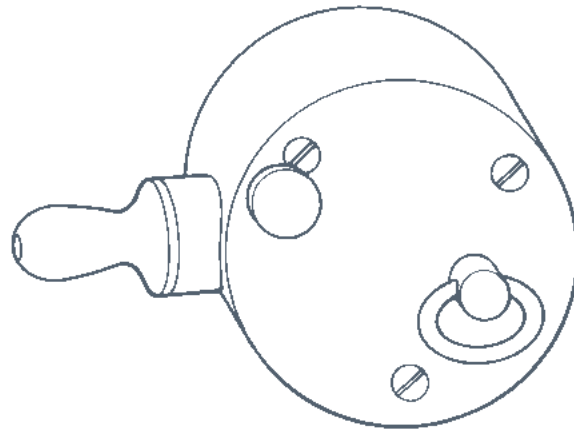

## PALATE LEVER

**Angell James**

225mm

7655/05

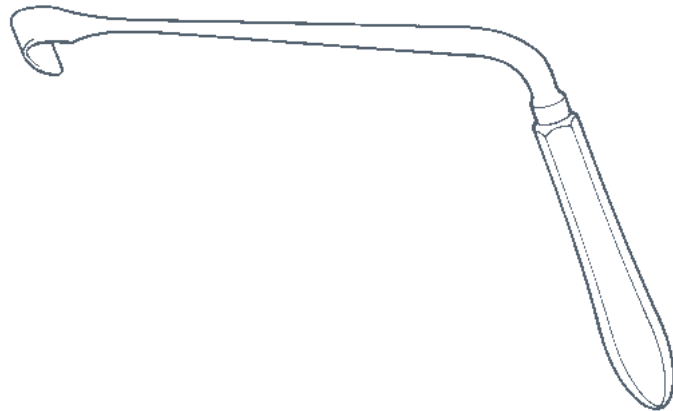

## PERFORATORS

**Myles**

170mm

7660/05 16fg, 5.3mm

7660/10 19fg, 6.3mm

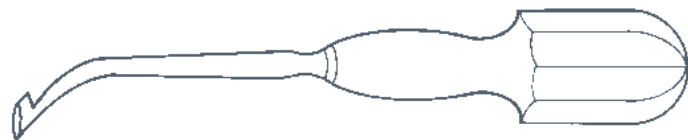



## PITUITARY FORCEPS

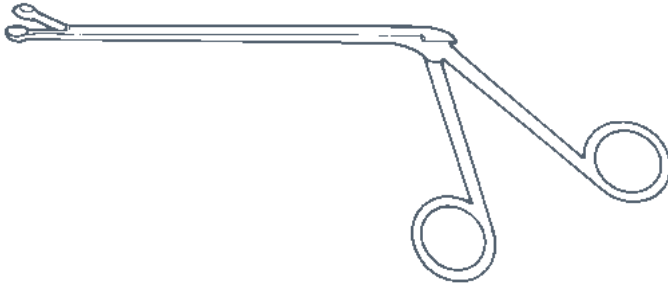

### Bateman

crocodile jaws, fenestrated

**7665/05** 150mm effective length



### Wilson

flattened tip, 3mm bite

**7668/05** 145mm effective length

## PROBES



### Jobson Horne

double ended

**7675/05** 140mm

**7675/10** 175mm

## PUNCH FORCEPS

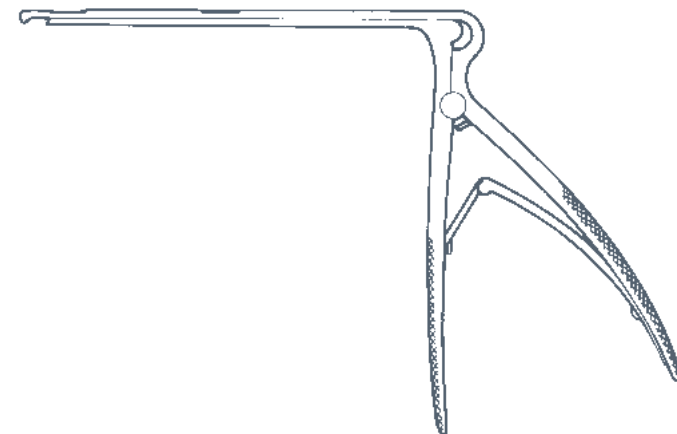

### Angell James

downward cutting, 150mm effective length 2mm  
60° bite

**7685/05**



downward cutting, 150mm effective length 2mm  
right angle bite

**7685/10**



upward cutting, 150mm effective length 2mm 60°  
bite

**7685/15**



upward cutting, 150mm effective length 2mm  
right angle bite

**7685/20**





## PUNCH FORCEPS

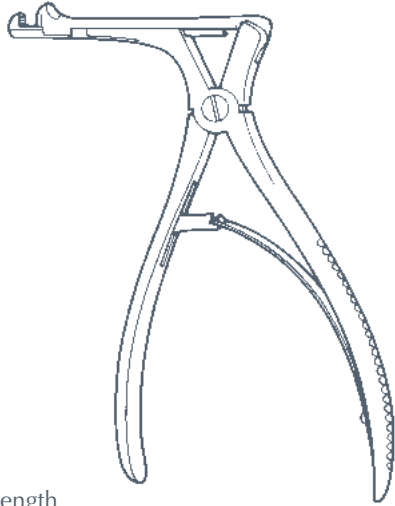

### Citelli

73mm effective length  
**7688/05** 2mm bite  
 75mm effective length  
**7688/10** 4mm bite

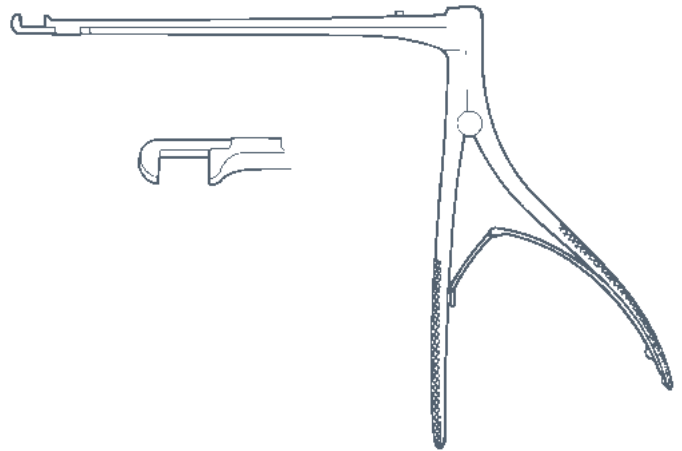

### Hajek Sphenoidal

upward cutting, 145mm effective length  
**7700/05** 4mm bite  
**7700/10** 5mm bite  
 downward cutting, 145mm effective length  
**7700/15** 4mm bite  
**7700/20** 5mm bite

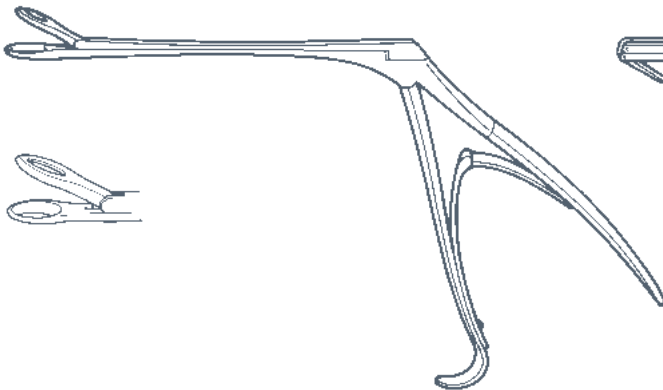

### Henckel

spring action  
**7701/05** 115mm effective length

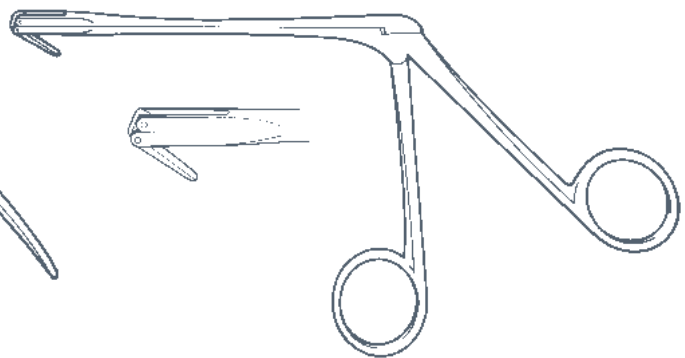

### Ostrom

reverse action  
**7703/05** 175mm effective length



## PUNCH FORCEPS

### St Bartholomew's

scoop blades, 112mm effective length

7706/05 straight, 3mm bite

7706/10 upward cutting, 3mm bite

7706/15 downward cutting, 3mm bite

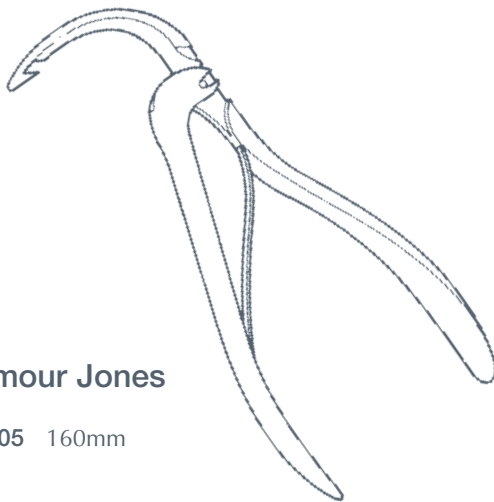
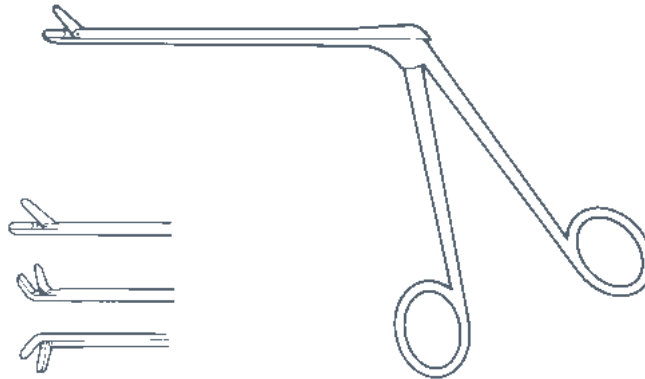

### Seymour Jones

7709/05 160mm

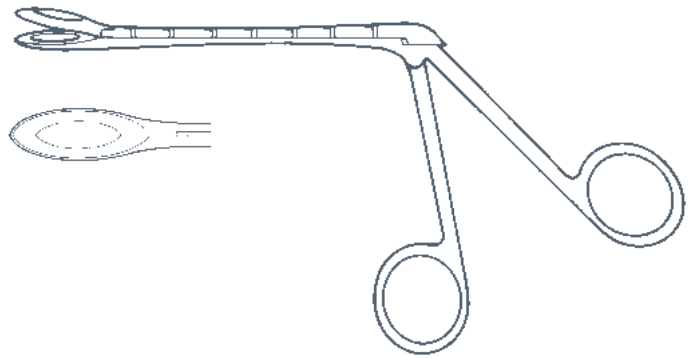

### Tilley Henckel

112mm effective length

7712/05 4.5mm bite

7712/10 5.5mm bite

7712/15 6.5mm bite

7712/20 8.0mm bite

## RETRACTORS

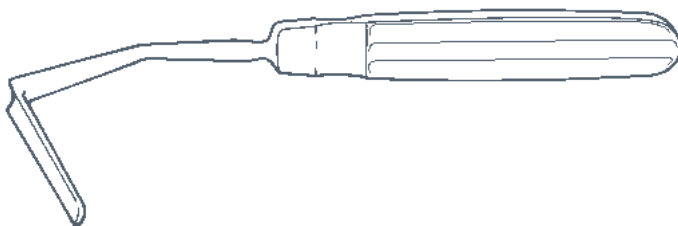

### Aufricht

7720/05 160mm



## RETRACTORS, SELF-RETAINING



**Mollison**

curved, 2/2 teeth  
7726/05 135mm

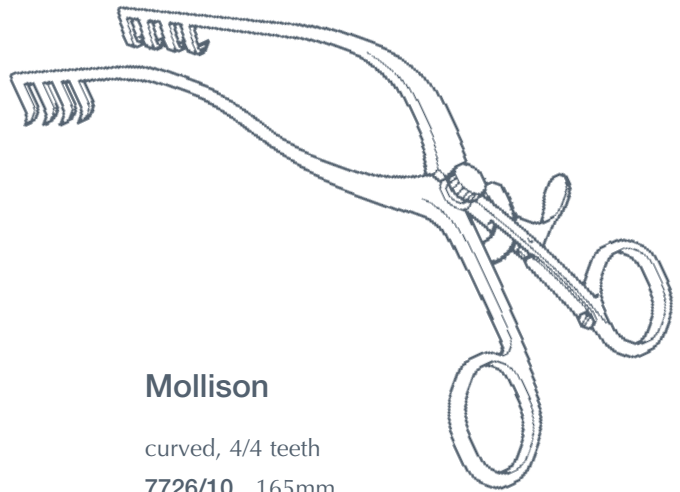

**Mollison**

curved, 4/4 teeth  
7726/10 165mm

## RUGINES

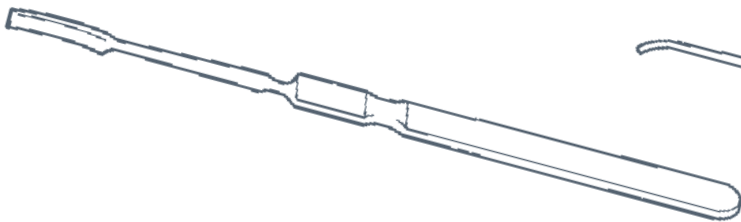

**Lempert**

broad  
7729/25 170mm

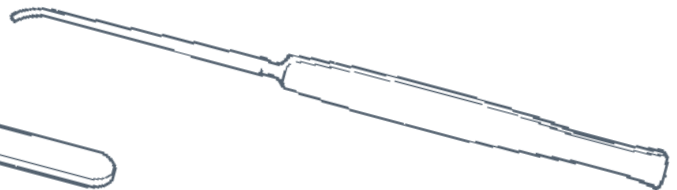

**Lempert**

narrow  
7729/50 155mm

## SCISSORS

**Cawthorne**

crocodile, black finish, extra fine  
70mm effective length  
7740/05





## SCISSORS

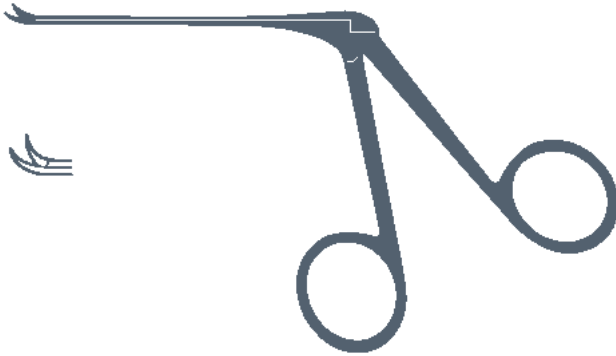

### Ormerod

crocodile, black finish, extra fine,  
curved upwards 70mm effective length  
7743/05

### Portmann

crocodile, satin finish, 70mm effective length  
curved to the left  
7746/25

crocodile, satin finish, 70mm effective length  
curved to the right  
7746/50

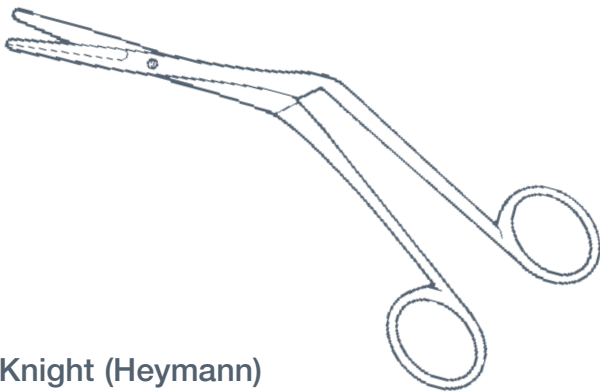
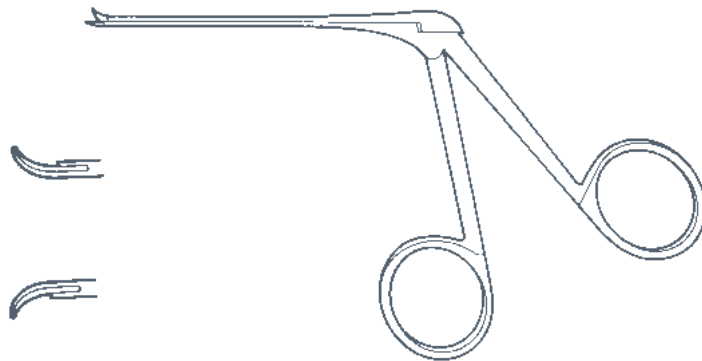

### Knight (Heymann)

175mm  
7755/05

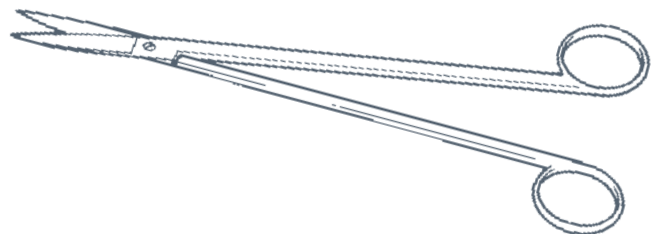

### Scott Stevenson Tonsil

215mm  
7758/05

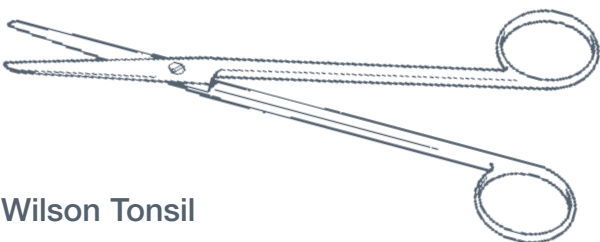

### Wilson Tonsil

200mm  
7761/05

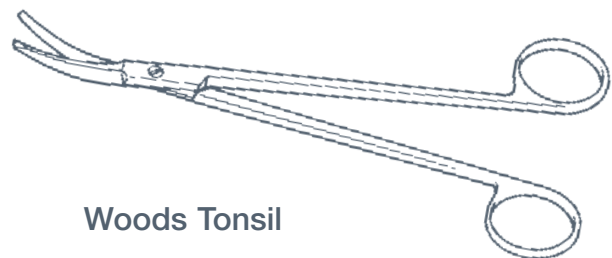

### Woods Tonsil

190mm  
7764/05



## SCOOPS

### Lempert

oval, 200mm

7770/10 No. 000

7770/15 No. 00

7770/20 No. 0

7770/25 No. 1

7770/30 No. 2

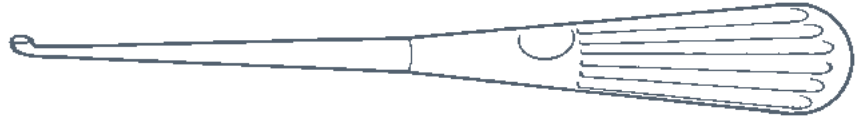

## SUCTION TUBES

### Barron

225mm

7780/08 4fg, 1.3mm

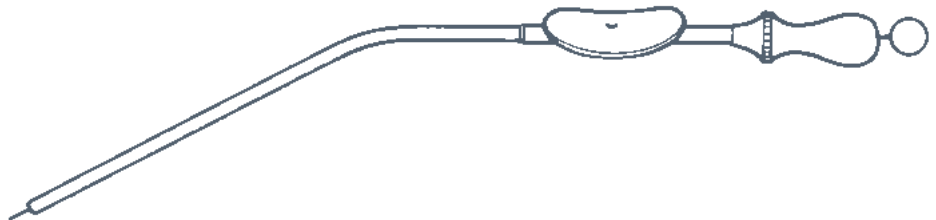

### Bellucci

170mm, complete with three detachable ends, 20, 22 and 24swg

7781/05 6fg

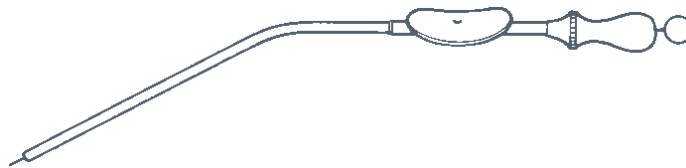

### Formby

conical tip, 210mm

7783/05 10fg, 3.3mm

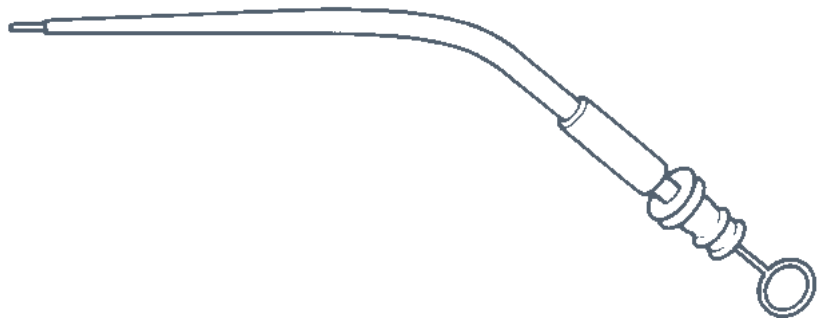

### House

125mm

7786/05 16swg x 18swg

7786/10 18swg x 20swg

7786/15 20swg x 22swg

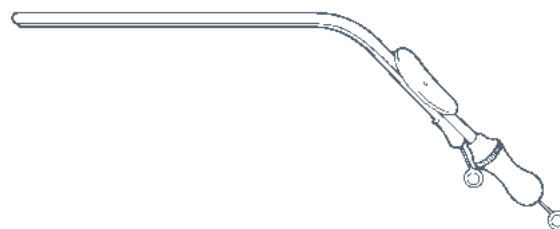





## SUCTION TUBES

### Lempert

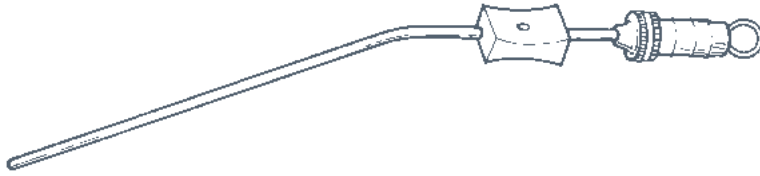

with stilette, 200mm

7792/05 6fg, 2mm

7792/10 9fg, 3mm

### Magill



with stilette, 210mm

7796/05 3.0mm

7796/10 3.5mm

7796/15 4.0mm

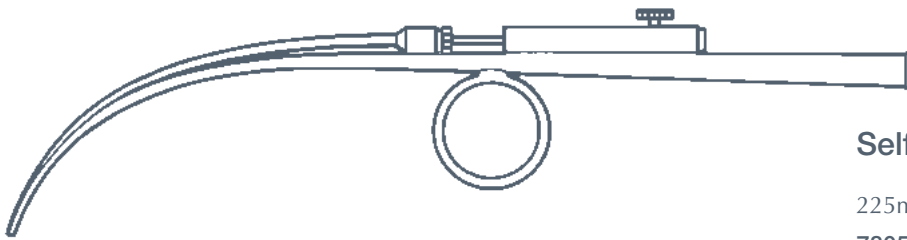

### Self-Clearing

225mm

7805/05 1.5mm

7805/10 2.0mm

7805/15 3.0mm



### Cut-Out Adaptor

7807/05 38mm

### Verhoeven



luer, 100mm

7808/05 16swg

7808/10 18swg

7808/15 20swg

7808/20 22swg

7808/25 24swg



## SUCTION TUBES

### Zoellner

tube with stilette  
7811/05 175mm



detachable ends

7812/05 18swg

7812/10 20swg

7812/15 22swg

7812/20 24swg

7812/25 26swg



## SYRINGE

### Aural

metal syringe complete with 2 tips, made in Pakistan

7820/05 50ml

7820/15 100ml

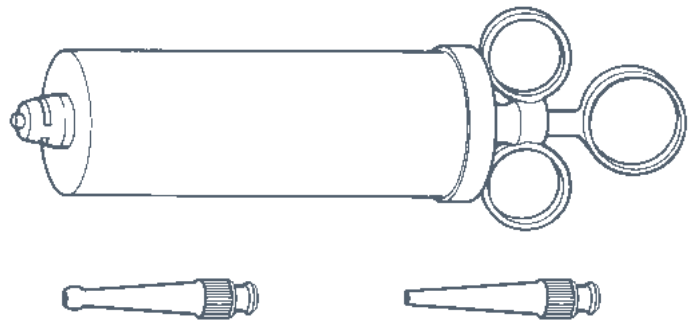

### Bacon Aural

7825/05 920mm

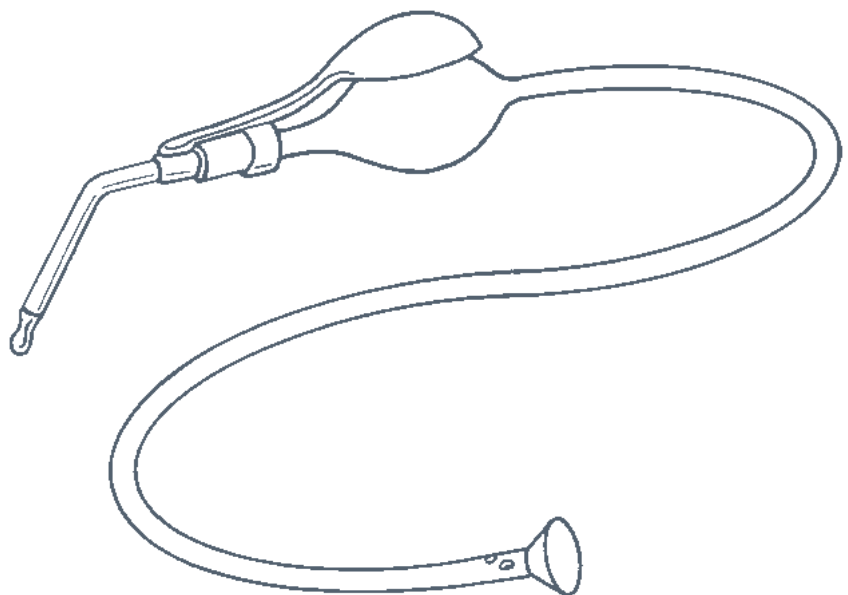



## TONGUE DEPRESSORS



### Flat

185mm  
7838/05

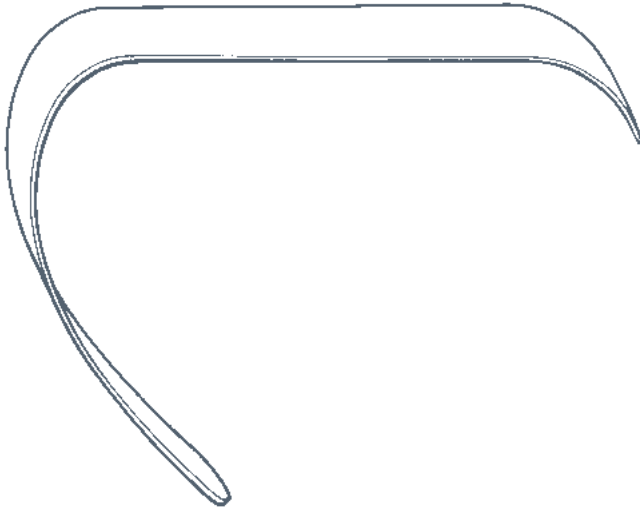

### Lack

child 12mm  
7841/05

adolescent 19mm  
7841/10

adult 22mm  
7841/15

## TONGUE FORCEPS

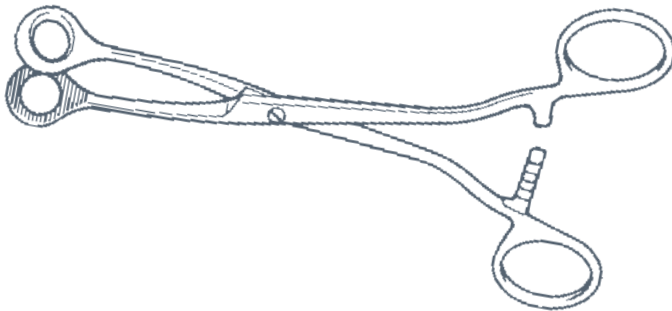

### Collin

screw joint 160mm  
7850/05

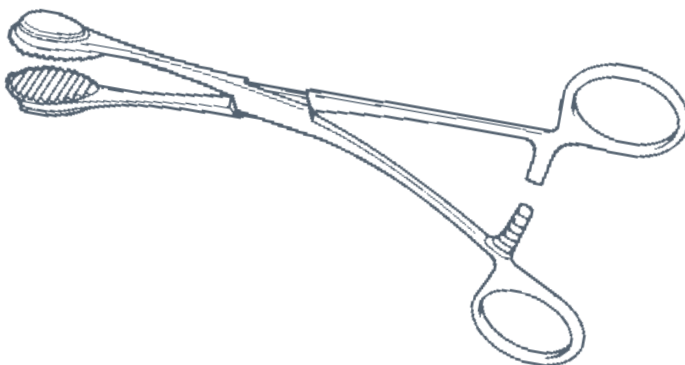

### Young

170mm  
7853/05



## TONSIL HOLDING FORCEPS

### Denis Browne

with rack 200mm

7860/25

without rack 200mm

7860/50

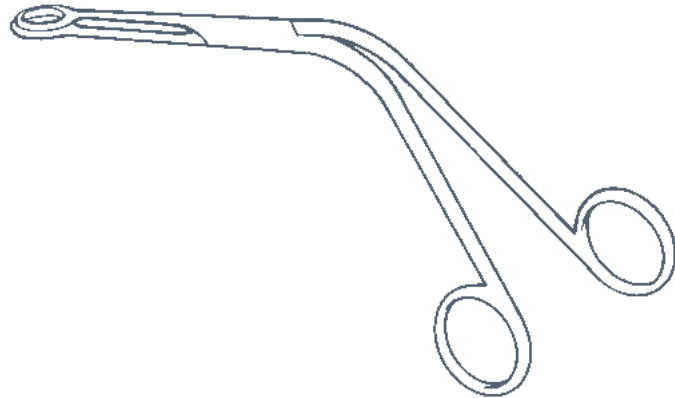

## TONSIL SNARE

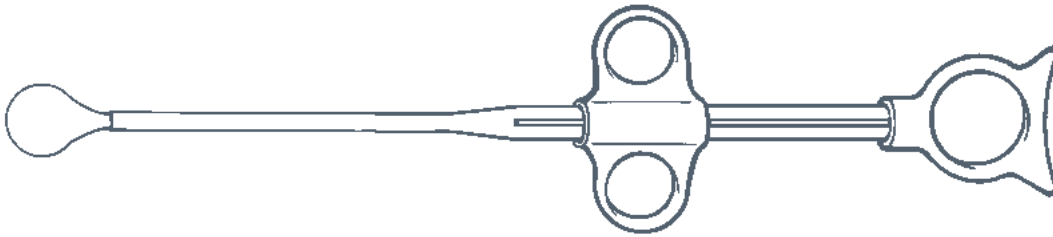

### Eve

275mm

7875/05

spare wire 25swg

7875/50

## TRACHEAL DILATORS

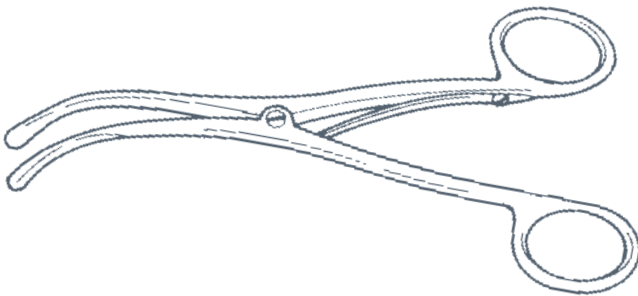

### Trousseau (Bowlby)

adult 140mm

7888/05

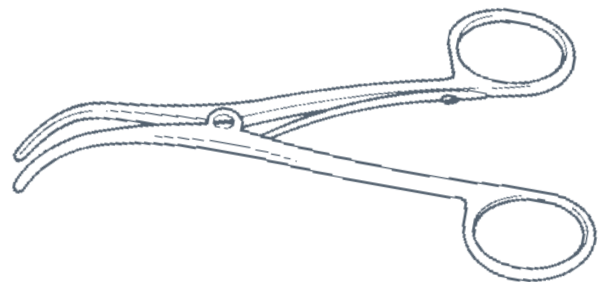

### Trousseau (Bowlby)

child 125mm

7888/10



## TRACHEOSTOMY TUBES

### Chevalier Jackson

Silver plated with one inner tube and pilot

- 7895/05 12fg
- 7895/07 14fg
- 7895/13 16fg
- 7895/15 18fg
- 7895/17 20fg
- 7895/23 22fg
- 7895/25 24fg
- 7895/27 26fg
- 7895/33 28fg
- 7895/35 30fg
- 7895/37 32fg
- 7895/43 34fg
- 7895/45 36fg

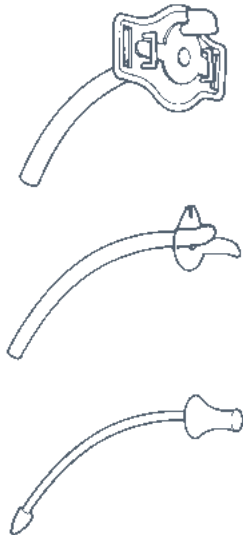

### Negus

Solid silver, inner tube with valve, plain inner tube with pilot

- 7901/05 16fg
- 7901/10 18fg
- 7901/15 20fg
- 7901/20 22fg
- 7901/25 24fg
- 7901/30 26fg
- 7901/35 28fg
- 7901/40 30fg
- 7901/45 32fg
- 7901/50 34fg
- 7901/55 36fg
- 7901/60 38fg
- 7901/65 40fg

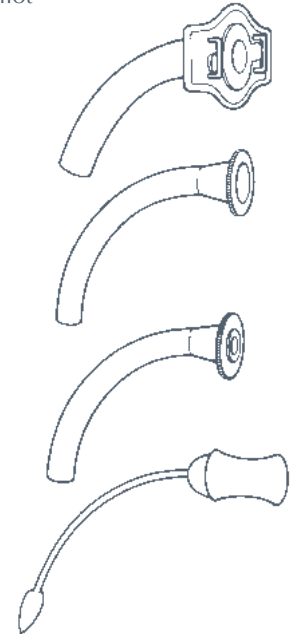

## TROCARS

### Tilley Harpoon

- 7910/05 170mm

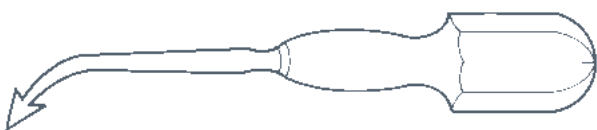

### Tilley Lichtwitz

cannula and tubing mount luer fitting, 195mm

- 7913/05 5fg
- 7913/10 6fg
- 7913/15 7fg
- 7913/20 8fg
- 7913/25 9fg

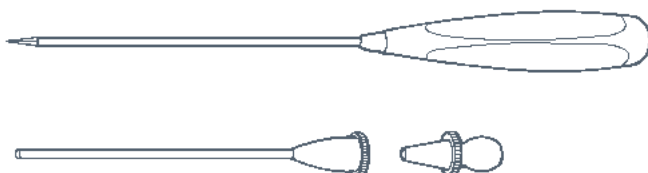



## TUNING FORKS

### Alloy

with foot

7920/05 C<sup>0</sup>, 128dv

7920/10 C<sup>1</sup>, 256dv

7920/15 C<sup>2</sup>, 512dv

7920/20 C<sup>3</sup>, 1024dv

7920/25 C<sup>4</sup>, 2048dv

7920/30 C<sup>5</sup>, 4096dv

7920/95 set of 6, complete in case

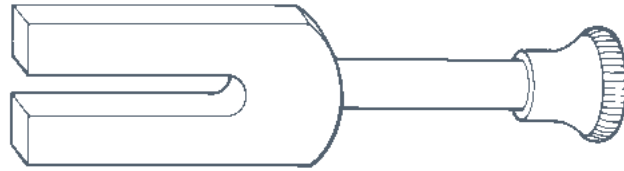

### Gardiner Brown

light pattern

7922/05 C<sup>0</sup>, 128dv

7922/10 C<sup>1</sup>, 256dv

7922/15 C<sup>2</sup>, 512dv

7922/20 C<sup>3</sup>, 1024dv

7922/25 C<sup>4</sup>, 2048dv

7922/30 C<sup>5</sup>, 4096dv

7922/95 set of 6, complete in case



### Hartmann

with foot

7926/05 C<sup>0</sup>, 128dv

7926/10 C<sup>1</sup>, 256dv

7926/15 C<sup>2</sup>, 512dv

7926/20 C<sup>3</sup>, 1024dv

7926/25 C<sup>4</sup>, 2048dv

7926/30 C<sup>5</sup>, 4096dv

7926/95 set of 6, complete in case



## TURBINATE FORCEPS

### Grunwald

narrow punch jaws,  
105mm effective length

7935/05 pattern A

7935/10 pattern B

7935/15 pattern C

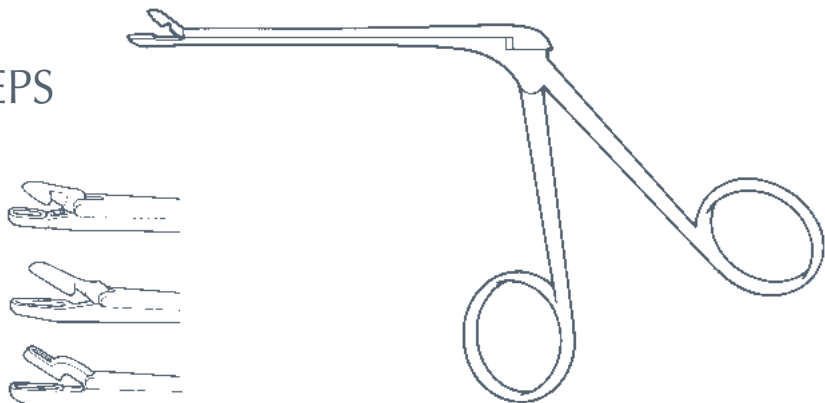



## TURBINATE FORCEPS

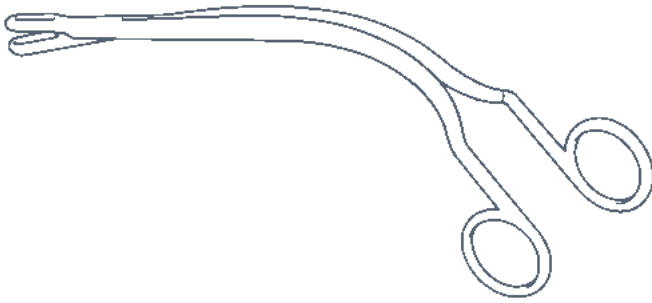

### Irwin Moore

190mm  
7938/05

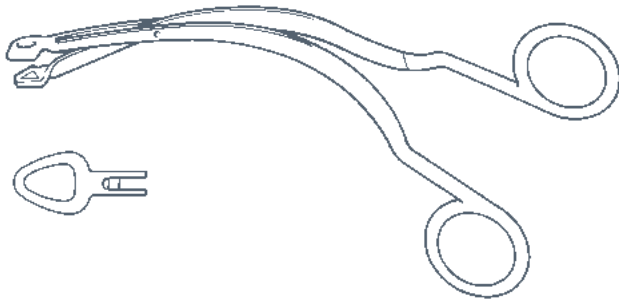

### Luc

heart-shaped, 175mm  
7941/05 small  
7941/10 medium  
7941/15 large

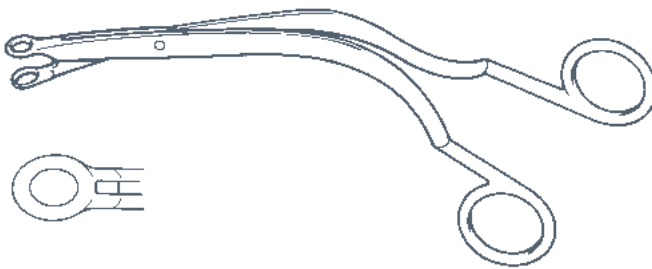

### Luc

oval, 190mm  
7942/05 small  
7942/10 medium  
7942/15 large

## WOOL CARRIERS

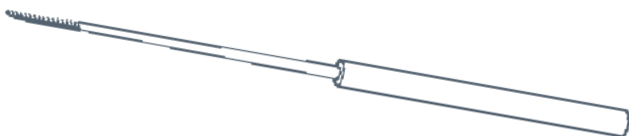

### Heath

fine 170mm  
7955/05

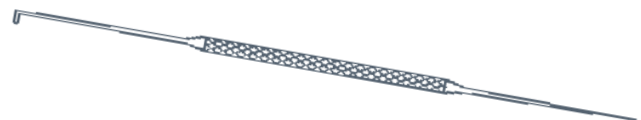

### Musgrove

175mm  
7958/05







## BONE AWLS



### Kelsey Fry

straight  
8005/05 145mm



### Kelsey Fry

curved  
8006/05 175mm

## BONE CUTTING FORCEPS

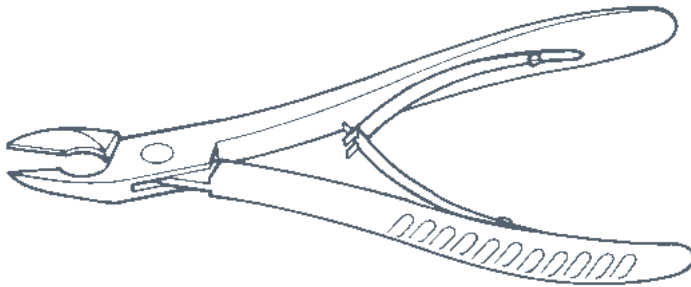

### Ward

slight angle  
8010/05 170mm

## CHISELS

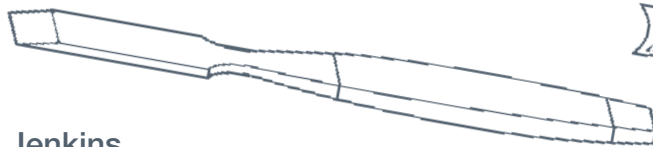

### Jenkins

length 145mm  
8025/05 2mm  
8025/10 4mm  
8025/15 6mm  
8025/20 8mm  
8025/25 10mm  
8025/30 12mm  
8025/35 14mm



### McIndoe

length 150mm  
8030/05 9mm  
8030/10 10mm  
8030/15 11mm  
8030/20 15mm



## CHISELS

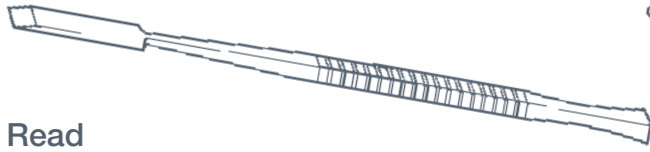

### Read

length 180mm  
8035/05 2mm  
8035/10 3mm  
8035/15 4mm  
8035/20 5mm

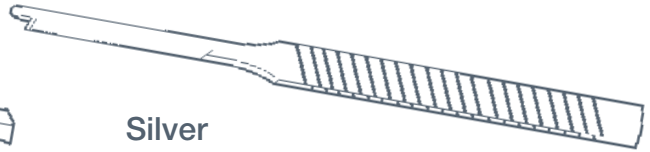

### Silver

straight  
8045/05 length 180mm

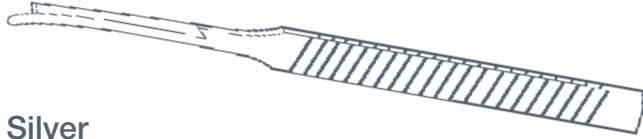

### Silver

curved to left  
8046/05 length 180mm

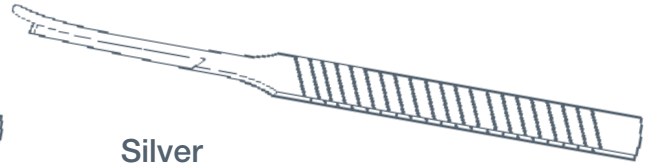

### Silver

curved to right  
8047/05 length 180mm

### Ward

length 180mm  
8055/05 3mm  
8055/10 5mm

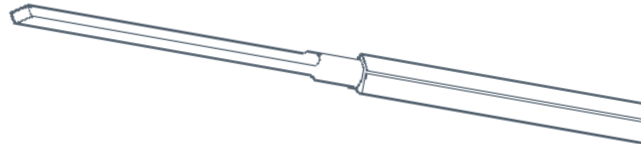

## COLLAR CRUSHING FORCEPS

### Denis Browne

8060/05 145mm

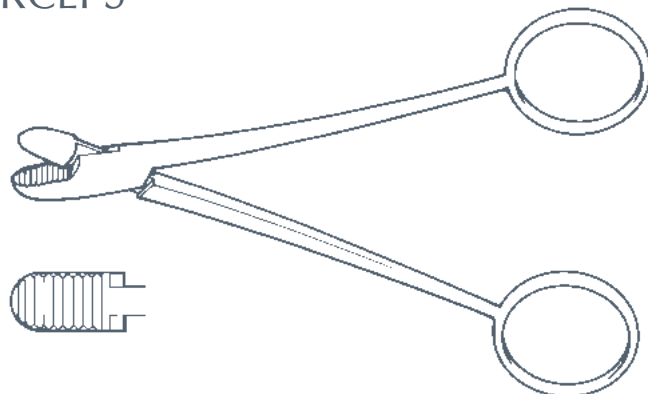



## CURETTES



### Exner

double ended, oval/round end  
8065/25 175mm



### Exner

double ended, angled oval ends  
8065/50 175mm



### Exner

double ended, angled round ends  
8065/75 175mm



### MacEwen

double ended  
8067/25 180mm oval  
8067/50 180mm round

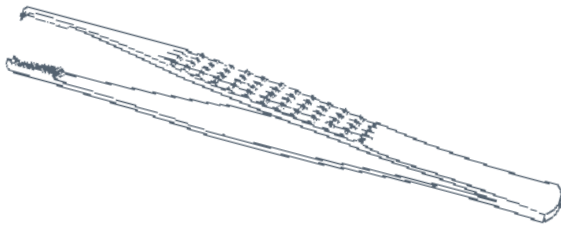

### Lanes

Rough handle, 1/2 teeth, serrated jaws  
8069/05 140mm  
8069/10 180mm

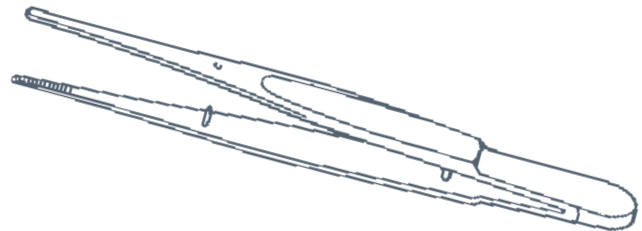

### Mount Vernon

serrated  
8070/05 100mm

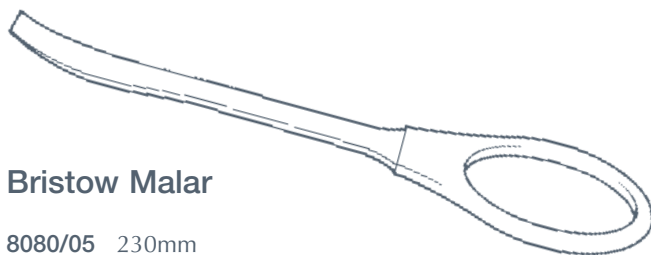

### Bristow Malar

8080/05 230mm

## DISSECTING FORCEPS

## ELEVATORS

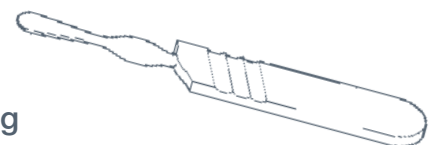

### Fickling

periosteal  
8085/05 130mm



## ELEVATORS

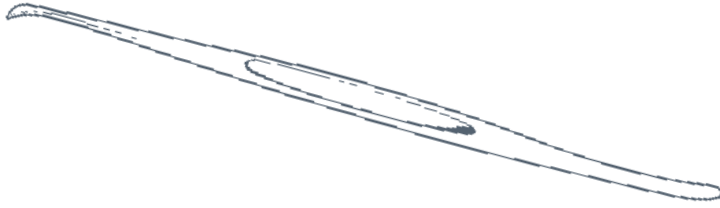

**Howarth**

double ended  
8090/05 220mm

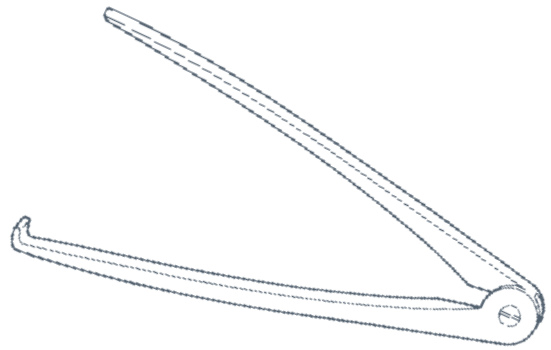

**Kilner Malar**

8095/05 180mm

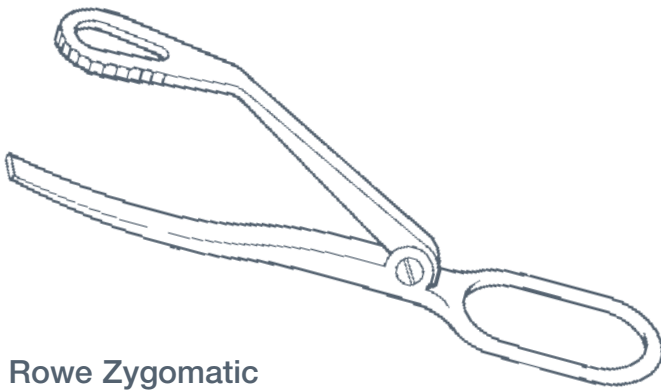

**Rowe Zygomatic**

8100/05 215mm

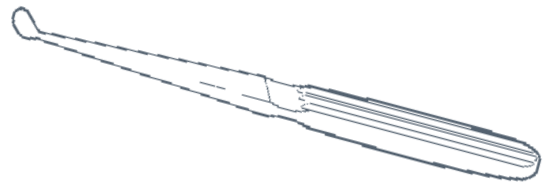

**Ward**

periosteal, fan shape  
8110/05 170mm

## FILES

**Alveolectomy**

double ended  
8115/05 170mm





## GOUGES

### Read



length 180mm

8125/05 2mm

8125/10 3mm

8125/15 4mm

8125/20 5mm

## MALLETS

### Fickling Dental

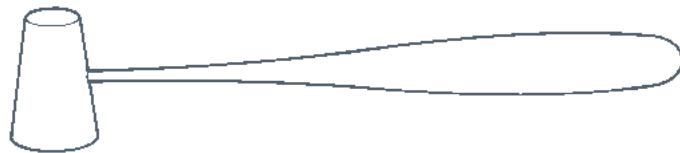

190mm x 25mm head

8135/05 6<sup>3</sup>/<sub>4</sub>oz

### Toffee Hammer

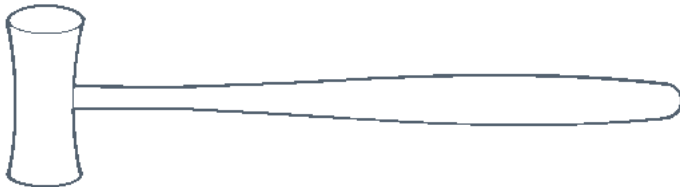

8140/05 340grms

## MAPPING PENS

### Eckhoff



complete

8145/05 145mm

8145/50 spare nib for above

### Sommerlad



complete with adjustable tip

8150/05 150mm





## MAXILLA INSTRUMENTS

### Awl

alveolar-pernasal wiring  
8155/05 225mm



### Awl

mandibular  
8156/05 140mm



### Awl

zygomatic suspension  
8157/05 180mm



### Chisel

Pterigoideus  
8158/05 235mm



### Osteotome

length 160mm  
8160/05 2.5mm  
8160/10 4mm



### Raspatory

curved  
8161/05 205mm x 5mm  
8161/10 205mm x 8mm  
8161/15 205mm x 9mm





## MAXILLA INSTRUMENTS



### Raspatory

curved, double ended  
8162/05 205mm



### Retractor

Awty osteotomy, 2 required  
8163/05 215mm x 12mm  
8163/10 215mm x 17mm

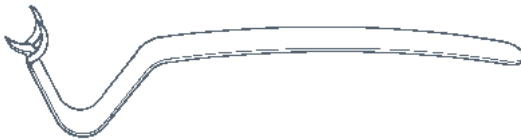

### Retractor

chin, holding  
8164/05 155mm

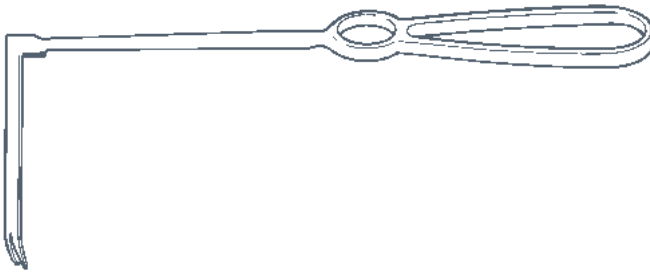

### Retractor

forked  
8165/05 220mm, 12mm x 70mm blade

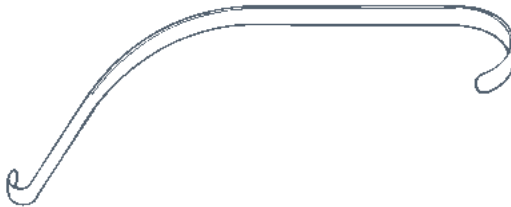

### Retractor

prognathism channel, 2 required  
8166/05 160mm

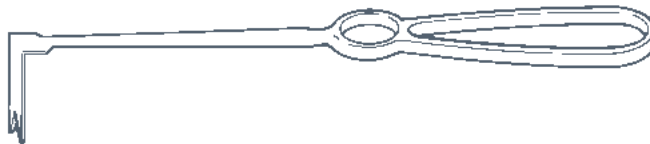

### Retractor

Spina Nasalis  
8167/05 220mm, 9.5mm x 44mm blade

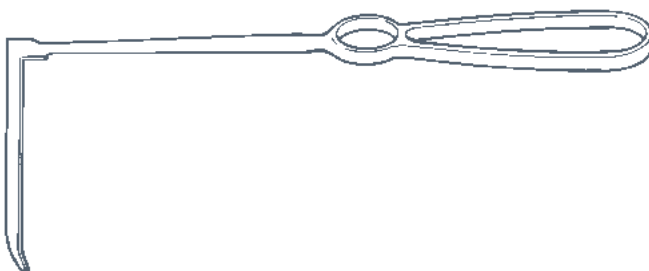

### Retractor

stripping  
8168/05 220mm, 14mm x 70mm blade



## MOUTH PROPS

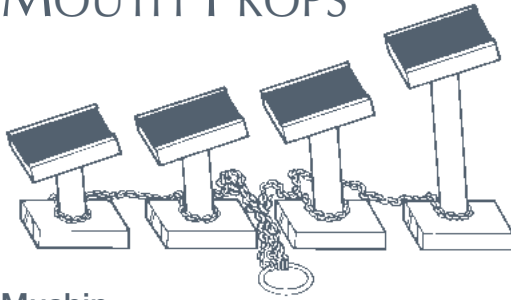

### Mushin

8175/05 set of 4 complete on chain

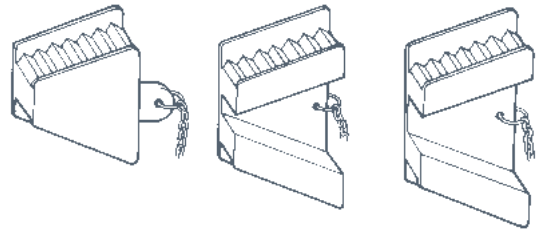

### Rubber

8180/05 small

8180/10 medium

8180/15 large

8180/95 set of 3 complete on chain

## NASAL SAWS

### Joseph

vertical shaft, 185mm

8185/25 cranked to the left

8185/50 cranked to the right

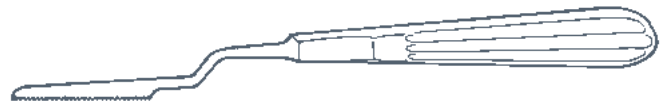

## NEEDLEHOLDERS

### Foster Miniature

left hand

8193/25 125mm

right hand

8193/50 125mm

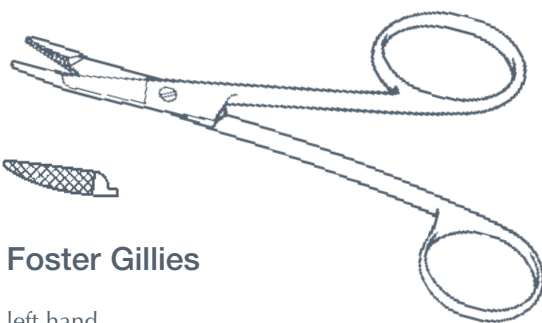
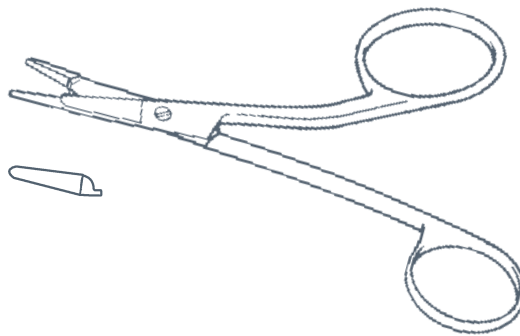

### Foster Gillies

left hand

8195/25 130mm

right hand

8195/50 130mm

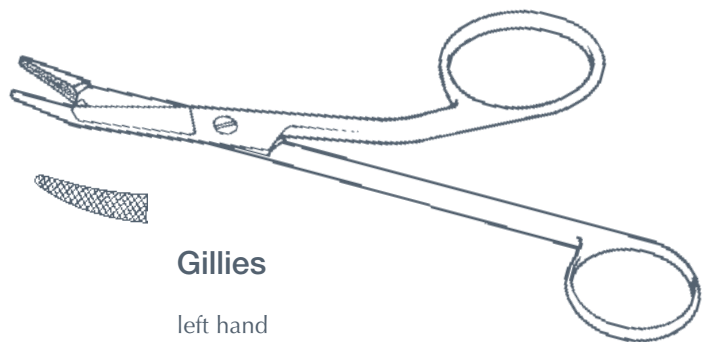

### Gillies

left hand

8200/25 165mm

right hand

8200/50 165mm





## NEEDLEHOLDERS, TUNGSTEN CARBIDE

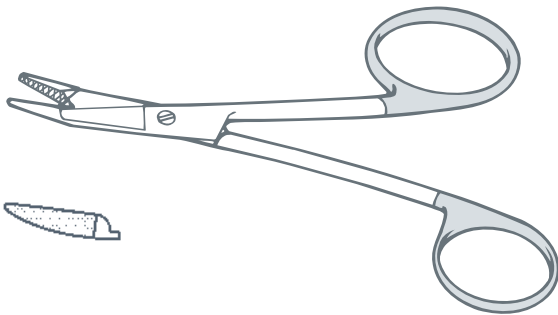

**Foster Gillies**

left hand  
8205/25 130mm  
  
right hand  
8205/50 130mm

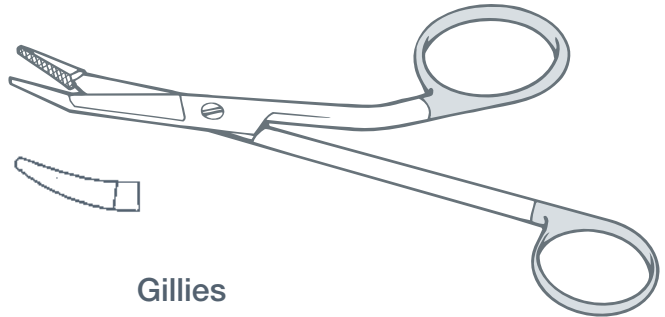

**Gillies**

left hand  
8210/25 165mm  
  
right hand  
8210/50 165mm

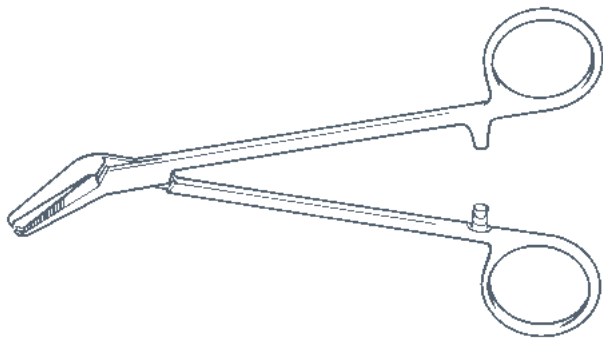

**Fickling**

serrated  
8215/05 180mm  
  
1/2 teeth  
8216/05 180mm



## ORAL FORCEPS

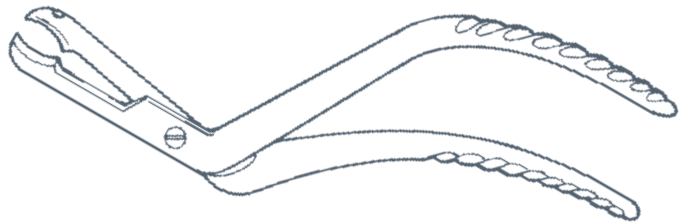

**Harrison Mandible**

screw joint  
8220/05 215mm

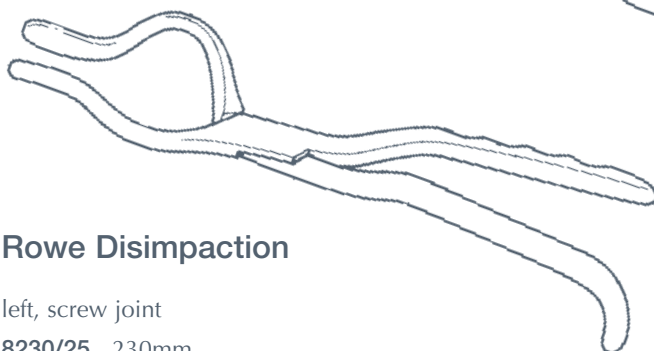

**Rowe Disimpaction**

left, screw joint  
8230/25 230mm

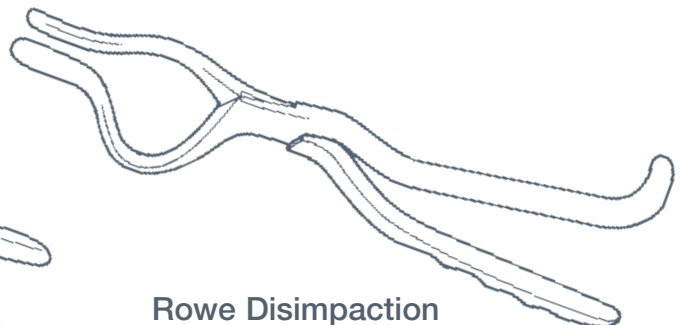

**Rowe Disimpaction**

right, screw joint  
8230/50 230mm



## OSTEOTOMES

### Gillies (French)

length 140mm

8240/05 5mm

8240/10 7mm

8240/15 9mm

8240/20 11mm



### Read

length 180mm

8245/05 4mm

8245/10 5mm



### Ward

length 180mm

8250/05 3mm

8250/10 5mm



## RASPATORIES

### Barsky

8270/05 double ended



### Cleft Palate

8275/25 curved downwards

8275/50 curved upwards



### Cleft Palate

curved upwards

8276/25 left

8276/50 right



### McIndoe

8278/05 small

8278/10 medium

8278/15 large





## RASPS



### Joseph Nasal

file end, fine  
8280/05 165mm



### Joseph Nasal

file end, coarse  
8281/05 165mm



### Joseph Nasal

fine teeth 1mm  
8282/05 165mm



### Joseph Nasal

coarse teeth 1.5mm  
8283/05 165mm



### Maltz

curved  
8290/05 165mm



### Maltz

straight  
8291/05 180mm



## RETRACTORS

### Bowdler-Henry Rake

8305/05 190mm

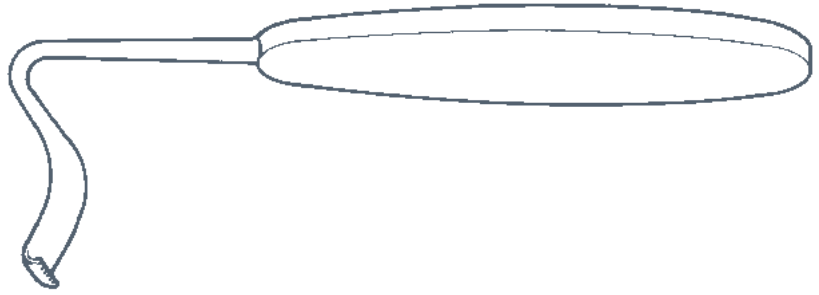

### Desmarres

140mm

8310/05 12mm wide

8310/10 14mm wide

8310/15 16mm wide



### Hajek

upper lip

8315/05 165mm

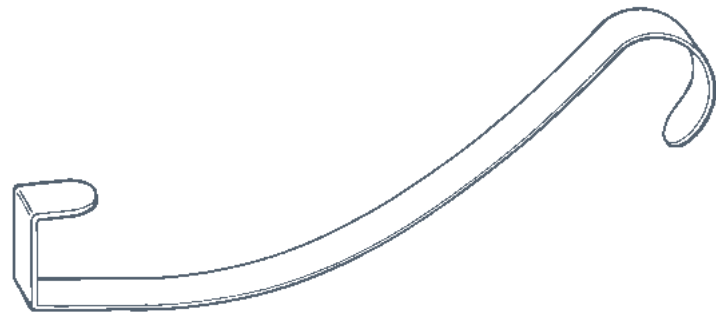

### Kay Austin

8320/05 140mm

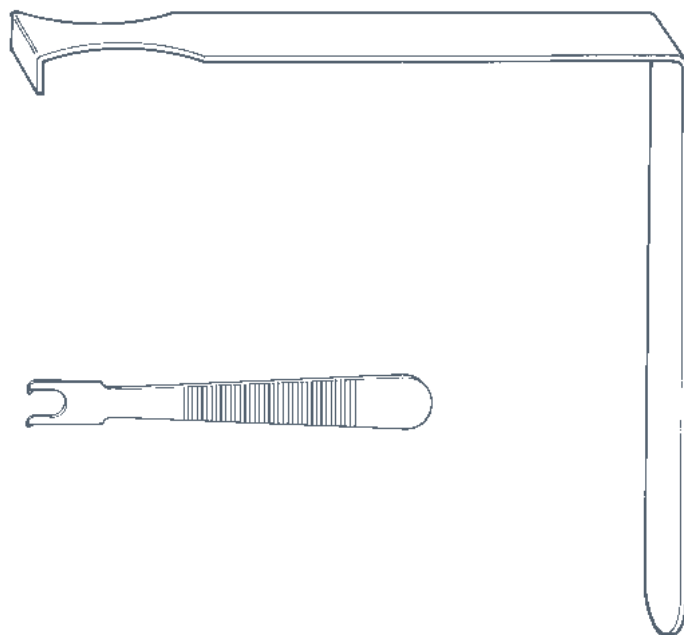

### Kilner Alae

8325/05 85mm x 10mm

8325/10 85mm x 13mm





## RETRACTORS

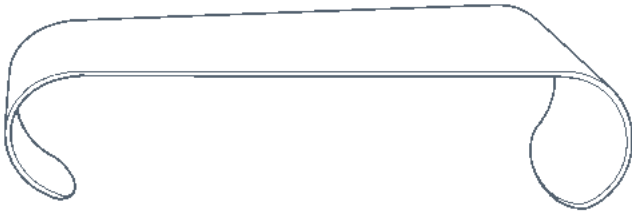

### Kilner Cheek

double ended

8330/05 25mm x 19mm

8330/10 35mm x 30mm



### Kilner Double Ended

8333/05 150mm

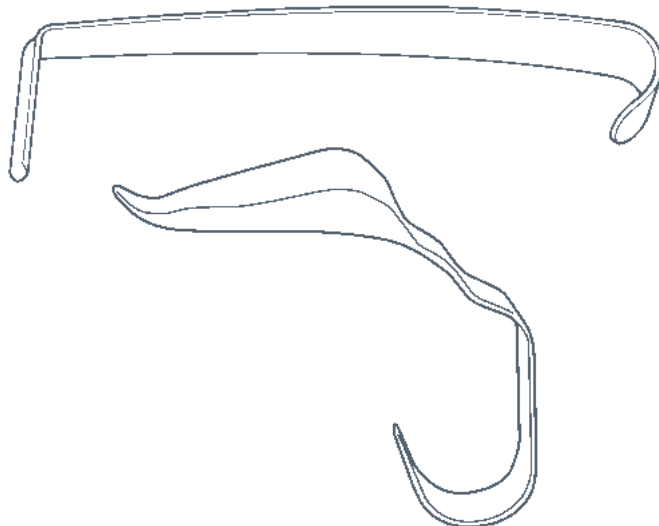

### Kilner Nasal

8335/05 150mm

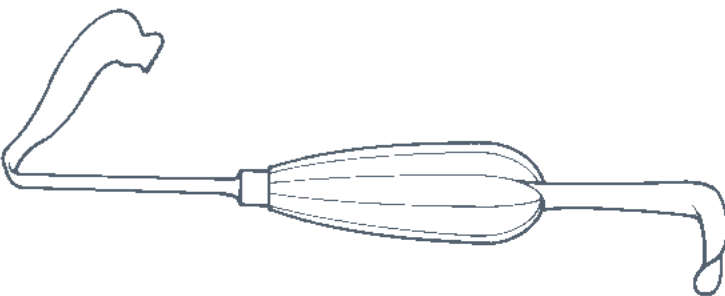

### Rowe Buccal

double ended, curved to left

8345/25 215mm

double ended, curved to right

8345/50 215mm



### Rowe Lingual

double ended, curved to left

8350/25 250mm

double ended, curved to right

8350/50 250mm



## RETRACTORS

### Ward Cheek

double ended  
8355/05 150mm

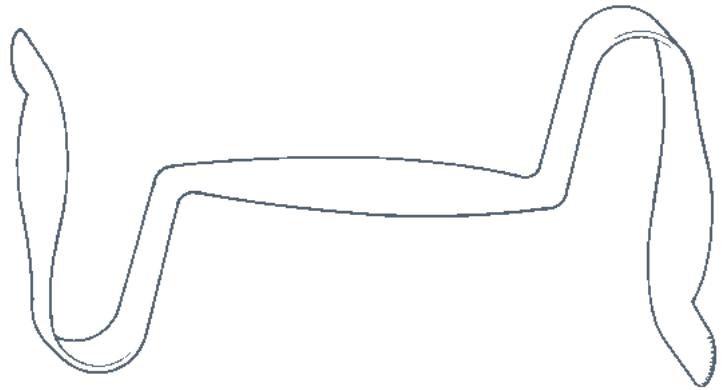

## RETRACTORS, SELF-RETAINING

### Alms

8357/05 70mm  
8357/10 100mm

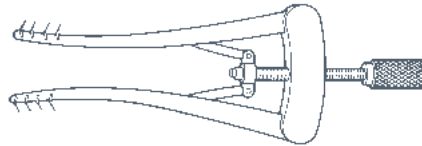

## SCALPELS

### Barron Handle

for use with No. 10, 11, 12 and 15 blades  
8360/05 130mm



## SCISSORS

### Alar Cartilage

curved  
8363/05 110mm

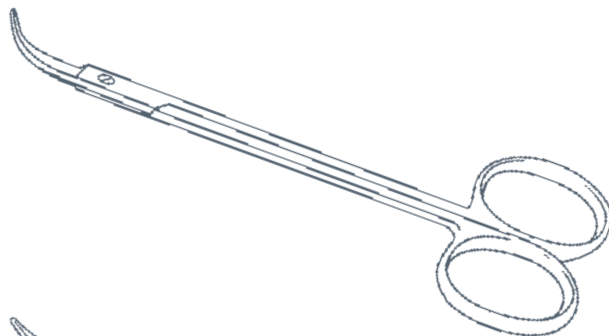

### Campbell Suture

curved, needle points  
8365/05 100mm

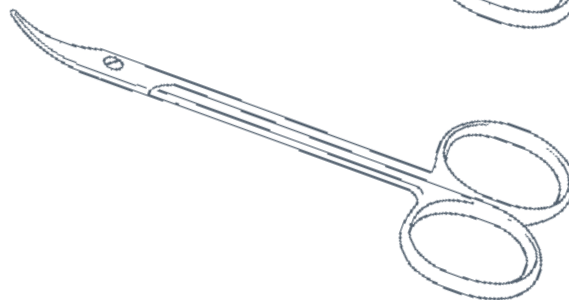



## SCISSORS

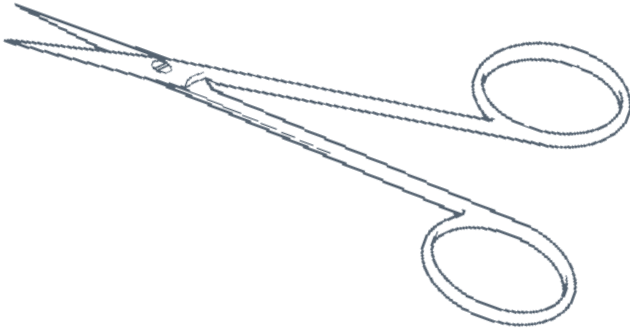

### Kilner

straight, sharp points, rounded blades  
8370/05 110mm

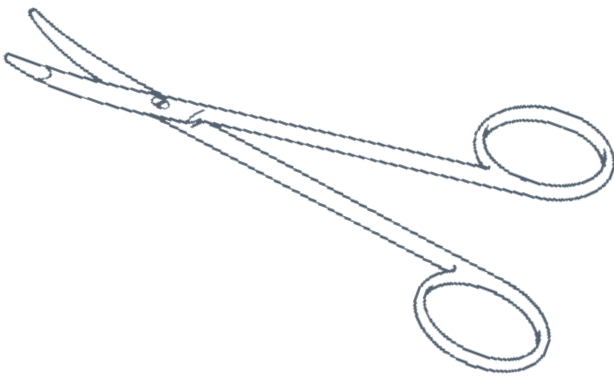

### Kilner

curved, blunt points  
8371/05 110mm

## SEPTUM FORCEPS

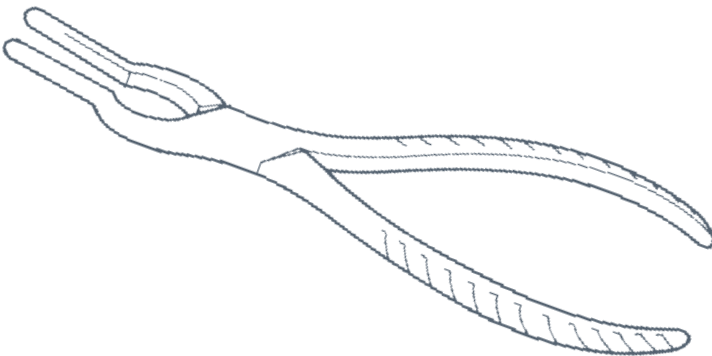

### Asch

8380/05 235mm

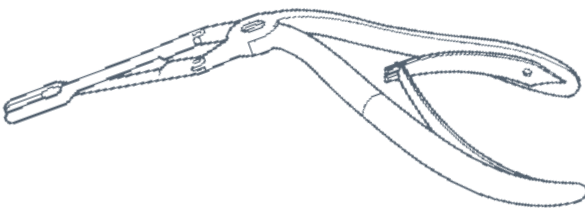

### Jansen-Middleton

double action  
8385/05 185mm



## SEPTUM FORCEPS

### Walsham

redressing, left  
8390/25 220mm

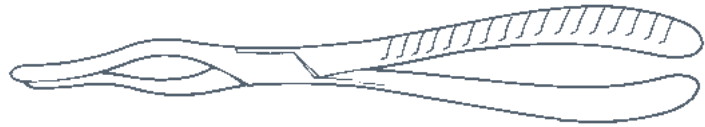

### Walsham

redressing, right  
8390/50 220mm



### Walsham

straight  
8390/75 190mm



## SKIN GRAFT BOARDS

### Wood

bevelled edge  
8395/05 180mm x 90mm

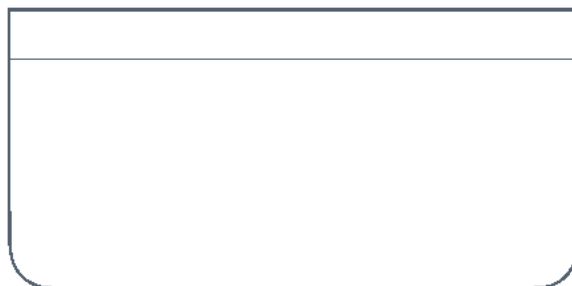





## SKIN GRAFT KNIVES

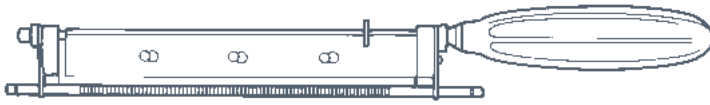

### Braithwaite

complete with 10 blades  
8400/05 305mm

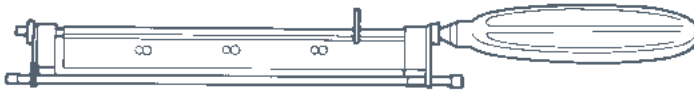

### Cobbett

complete with 10 blades  
8405/05 305mm  
8406/05 spare blades for Braithwaite,  
Cobbett and Watson knives



### Silver

complete with blade, 190mm  
8410/25 right hand  
8410/50 left hand  
8410/90 spare blade

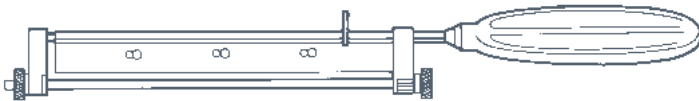

### Watson

complete with 10 blades  
8412/05 305mm

## SKIN HOOKS



### Gillies

185mm  
8420/05 small  
8420/10 large



### Kilner

8425/05 140mm



### McIndoe

8430/05 190mm



### McIndoe Double

length 150mm  
8435/05 9mm  
8435/10 10mm  
8435/15 11mm



## SUTURE FORCEPS

### Mustarde

8437/05 125mm



## WIRE CUTTERS

### Tungsten Carbide Jaws

to cut 0.5mm hard wire, or 0.7mm soft

8450/05 140mm

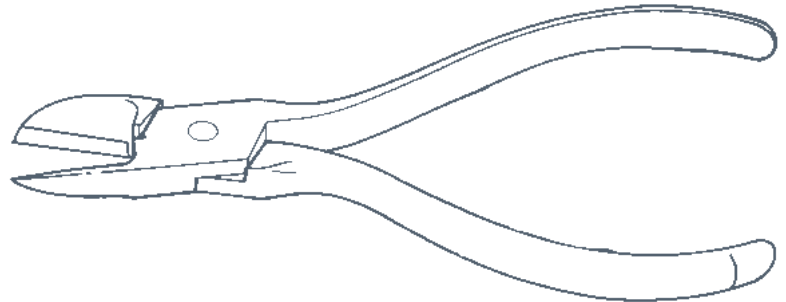

## WIRE FORCEPS

### Hayton Williams

8455/05 112mm

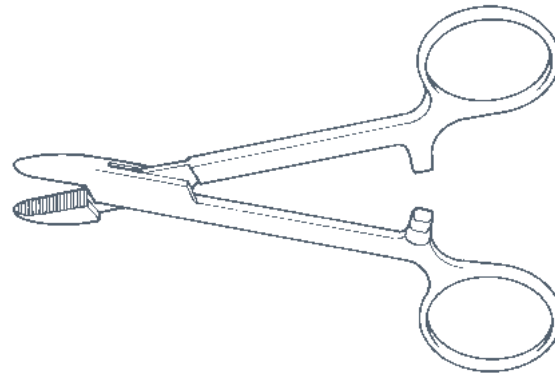

### Lawson Tait

Pattern A

8457/25 140mm



Pattern B

8457/50 140mm

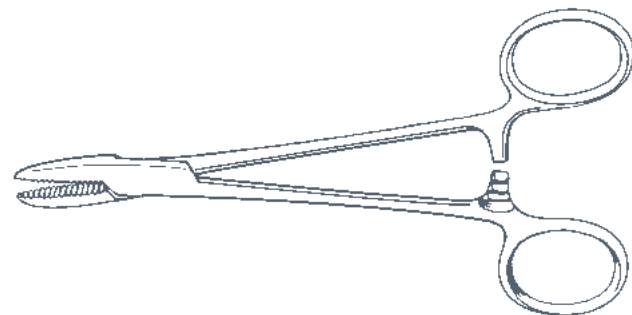

**A**

<b>Abel</b>	96
Scissors	
<b>Abrams</b>	
Biopsy Punch	63
<b>Adams</b>	
Pliers Tenotomy	130
Knives	166
<b>Adson</b>	
Diathermy Forceps	13
Dissecting Forceps	15
Dissecting Forceps, (Bayonet)	142
Dural Hooks	144
Elevators (Periosteal)	145
Retractors, Self-Retaining	36
<b>Adson (Fraser)</b>	
Artery Forceps	1
Suction Tubes	155
<b>Agnew</b>	
Myringotomes	199
<b>Alar</b>	
Scissors	232
<b>Albee</b>	
Osteotomes	169
<b>Allis</b>	
Tissue Forceps	58
<b>Allison</b>	
Lung Retractors	67
<b>Alms</b>	
Retractors, Self-Retaining	232
<b>Alveolectomy Files</b>	222
<b>Amalgam</b>	
Carrier	115
Instruments	115
<b>American</b>	
Spinal Curettes	142
Suction Tubes	57
<b>Amputation Saws</b>	38
<b>Anchoring Forceps</b>	
Robin	1
<b>Aneroid Sphygmomanometer</b>	55
<b>Aneurysm Needles</b>	29
<b>Angell James</b>	
Palate Lever	204
Punch Forceps	205
<b>Apical</b>	
Elevators	99,100
Exolevers	102
<b>Apical Clinic</b>	
Exolevers	102
<b>Artery Forceps</b>	
Adson (Fraser)	1
Birkett Bland	179
Sutton	1
Cairns	139
Crile	139

Cushing	140
Dunhill	1
Fraser Kelly	2
Grey Turner	2
Harrison Cripps	2
Heiss	2
Jolls Thyroid	2
Kelly-Crile	3
Kilner	3
Kocher	3
Mayo	3
Mayo Oschner	3
Miles Phillips	4
Mixer	4
Mixer Baby	4
Mosquito,	4
Halstead Mosquito,	5
Micro Moynihan	5
Negus	179
Oschner	5
O'Shaughnessy	5
Roberts	63
Rochester-Pean	6
Ronald Edwards	6
Sawtell	179
Schmidt	179
Spencer-Wells	6
Wilson	179
<b>Arthur</b>	
Splinter Forceps	55
<b>Asch</b>	
Septum Forceps	233
<b>Aspirating Syringe</b>	133
<b>Aufricht</b>	
Retractors	207
Scissors	41
<b>Aural Dressing Forceps</b>	
Hartmann	183
Hunter Tod	183
Lucae	183
Tilley	183
Wilde	184
<b>Aural Forceps</b>	
Cawthorne	180
Fuller	180
Hartmann	180
Henckel	181
Hough	181
House-Dieter	181
McGee	182
Ormerod	182
Shea	182
Tabb Crura	183
<b>Aural Instruments</b>	
Crowthorne	184
Rosen	185
Schuknecht	186
Tray	186
<b>Aural Snare</b>	
Glegg	187
<b>Aural Specula</b>	
Rosen	187
Siegle (Peters)	187

Tumarkin	187
<b>Aural Syringe</b>	212
<b>Auvard</b>	
Vaginal Specula	84
<b>Awl</b>	
Bone	157
Maxilla Instruments	224

**B**

<b>Babcock</b>	
Tissue Forceps	58
<b>Backhaus</b>	
Towel Clips	59
<b>Bacon</b>	
Syringe	212
<b>Bailey</b>	
Rib Spreaders	68
<b>Balfour</b>	
Retractors, Self-Retaining	36
<b>Ballenger</b>	
Nasal Knives	201
<b>Band Removing Pliers</b>	130
<b>Bandage</b>	
Esmarch	7
<b>Bankhart</b>	
Bone Levers	162
<b>Barany Noise Apparatus Barnes</b>	204
Obstetric Forceps	77
Scissors	80
<b>Barnhill</b>	
Curettes	191
<b>Barron</b>	
Haemorrhoid Ligator Set	93
Scalpels	232
Suction Tubes	210
<b>Barsky</b>	
Raspatories	228
<b>Bateman</b>	
Pituitary Forceps	205
<b>Baumgartner</b>	
Needleholders, TC	26
<b>Beaver Blade Holder</b>	135
<b>Beck</b>	
Rongeurs	150
<b>Beckmann</b>	
Curettes	191
<b>Bellucci</b>	
Suction Tubes	210
<b>Bennett</b>	
Bone Levers	162
<b>Berkeley-Bonney</b>	
Clamps	73
<b>Bickford</b>	
Dissecting Forceps	15
<b>Biopsy Forceps</b>	
Chevalier Jackson	188
Paterson	188
Yeomans	91



<b>Biopsy Punch</b>		<b>Bone Rasp/File</b>	164	<b>Capener</b>		
Abrams Pleural	63	<b>Bonney</b>		Chisels	163	
Eppendorf	71	Clamps Dissecting	73	Gouges	145	
Leech Wilkinson	71	Forceps Uterine	16	Osteotomes	169,170	
Schubert	71	Forceps	83	<b>Capsulotomy</b>		
Van Doren	71	<b>Bougies</b>		Scissors	175	
Wittner	71	Clutton	87	<b>Carless</b>		
<b>Bipod</b>		<b>Bowdler-Henry</b>		Scissors	42	
Draffin Magauran	189	Retractors	230	<b>Carriers</b>		
Plate	189	<b>Bowel Scissors</b>	41	Diathermy	12	
<b>Birkett</b>		<b>Bozemann</b>		<b>Cartilage</b>		
Artery Forceps	179	Dressing Forceps	76	Knives	22	
<b>Blacks</b>		Needleholders	23	Scissors	41	
Files	135	<b>Brace</b>		<b>Cartridge Syringe</b>	133	
Dental Instruments	117,118	Hudson	140	<b>Carvers, Dental</b>	116,117	
<b>Blake</b>		<b>Brain Knives</b>	22	<b>Catheter Introducers</b>		
Retractors, Amputation	36	<b>Braithwaite</b>		Foley Balloon	87	
Knives	128	Dissecting Forceps	16	Guyen	87	
<b>Bland Sutton</b>		Skin Graft Knives	235	<b>Catheters</b>		
Artery Forceps	1	<b>Braun-Stadler</b>		Female	72	
<b>Blount</b>		Scissors	80	Rotunda	72	
Staple Instruments	176	<b>Bristow</b>		Woakes Eustachian	189	
<b>Bohler</b>		Elevators	164,221	<b>Catlin</b>		
Bender	30	<b>Brodie</b>		Knives	22	
Stirrups	176	Probes	32	<b>Cawthorne</b>		
<b>Bone Awls</b>		<b>Bruns/Bohler</b>		Aural Forceps Aural	180	
Kelsey Fry	219	Shears	30	Instruments	184	
With eye	157	<b>Brush, Wire</b>	7	Cerumen Hooks	190	
<b>Bone Curettes</b>		<b>Bryant</b>		Nasal Forceps	199	
Charnley	157	Dressing Forceps	20	Scissors	208	
Stanley Boyd	157	<b>Burnishers, Dental</b>	115	<b>Cerumen Hooks</b>		
Volkman	157	<b>Burns</b>		Cawthorne	190	
<b>Bone Cutting Forceps</b>		Bone Holding Forceps	160	Formby	190	
Horsley	158	<b>Burs</b>		Lucae	190	
Liston	158	Hudson	141	St Barts	190	
Liston-Key	159	Paton	163	<b>Charnley</b>		
McIndoe	159	Tilley	189	Bone Curettes	157	
Paton	159	<b>C</b>			Bone Lever	162
Stamm	159	<b>Cable Diathermy</b>	11	Retractors	172	
Ward	219	<b>Cairns</b>		Retractors, Initial Incision	172	
<b>Bone Holding Clamps</b>		Artery Forceps	139	Retractors, Laminectomy	146	
Lowman	159	Dissecting Forceps	143	Suture Forceps	177	
<b>Bone Holding Forceps</b>		Dressing Forceps	144	<b>Chassar Moir</b>		
Burns	160	Dural Hooks	144	Scissors	80	
Fergusson	160	Retractors (strip)	146	<b>Cheatles</b>		
Hey Groves	160	Scissors	155	Steriliser Forceps	56	
Lane	160	<b>Campbell</b>		<b>Chevalier Jackson</b>		
Necrosis (Sequestrum)	160, 161	Scissors	232	Biopsy Forceps	188	
St Thomas	161	<b>Canadian</b>		Laryngeal Forceps	195	
Verbrugge	161	Dissecting Forceps	16,17	Nodule Forceps	203	
<b>Bone Hooks</b>		<b>Cannula</b>		Tracheostomy Tubes	215	
Langenbeck	161	Cone Ventricular	141	<b>Chip Syringe</b>	133	
Kocher	161	Jefferson Ventricular	141	<b>Chirobody Instruments</b>		
<b>Bone Levers</b>		Leech Wilkinson	72	Blacks Files	135	
Bankhart	162	Spackman Intra Uterine	72	Probes	135	
Bennett	162	<b>Canny Ryall</b>		Beaver Holder	135	
Chamley	162	Retractors	33	Chisel	135	
Fagge	162	<b>Carver</b>		<b>Chiropody Knives</b>		
Lane	162	Chisels	163	Scalpels	136	
Murphy Skid	162	Gouges	145			
Trethowan	162	Osteotomes	169,170			



<b>Chiropody Nippers</b>					
Concave	136				
Flat	136				
Thwaites	137				
<b>Chiropody Scissors Chisels</b>	137				
Capener	163				
Chiropody	135				
Coupland	99				
Jenkins	219				
McIndoe	219				
Maxilla	224				
Post Mortem	31				
Read	220				
Silver	220				
Smith Petersen	163				
Swedish	163				
Ward	220				
<b>Cholecystectomy Forceps</b>					
Geary Grant	7				
Lahey	7				
Moynihan	7				
<b>Citelli</b>					
Punch Forceps	206				
<b>Clamps</b>					
Berkeley-Bonney	73				
Bonney	73				
Crafoord	63				
Doyen Intestinal	8				
Faure	73				
Fergusson Angiotribe	8				
Finch	91				
Guard, Parker Kerr	9				
<b>Clamps (cont)</b>					
Gwilliam	73				
Heaney	74				
Kocher Intestinal	8				
Lanes Intestinal	8				
Lanes Twin	9				
Lang Stevenson	9				
Lloyd-Davies	91				
Maingot	74				
Parker Kerr	9				
Payr	10				
Schoemaker-Ogilvie	10				
Semb	63				
Thomson-Walker Pedicle	88				
Thomson-Walker Penile	88				
<b>Clamps, Atraumatic</b>					
DeBakey	64,65				
Doyen	10				
Einsell Foss	91				
Hayes	92				
Herrick	88				
Hysterectomy	74				
Satinsky	65,66				
<b>Cleft Palate Raspatories</b>	228				
<b>Clip Forceps</b>					
Comyns Berkeley	11				
McKenzie	142				
Michel	11				
Raney	142				
<b>Clutton</b>					
Bougies	87				
<b>Cobb</b>					
Elevator Periosteal	145				
Elevator	164				
<b>Cobbett</b>					
Skin Graft Knives	235				
<b>Coleman</b>					
Elevators	100				
<b>Collar Crushing Forceps</b>					
Denis Browne	220				
<b>College Dressing</b>					
Tweezers	132				
<b>Collin</b>					
Tongue Forceps	213				
<b>Collingwood Stewart</b>					
Hernia Forceps	21				
<b>Comyns Berkeley</b>					
Clip Forceps	11				
<b>Conchotomes</b>					
Hartmann	190				
<b>Condensers, Dental</b>	115				
<b>Cone</b>					
Cannula	141				
Retractors, Self-Retaining	148				
<b>Continental</b>					
Dissecting Forceps	17				
<b>Cooper</b>					
Needles	29				
<b>Coupland</b>					
Chisels	99				
<b>Crafoord</b>					
Clamps	63				
<b>Crile</b>					
Artery Forceps	139				
<b>Crile Murray</b>					
Needleholders	23				
<b>Crile Wood</b>					
Needleholders	23				
Needleholders, TC	26				
<b>Crown &amp; Collar Scissors</b>	131				
<b>Cryer</b>					
Exolevers	103				
<b>Curettes</b>					
American Spinal	142				
Barnhill	191				
Beckmann	191				
Charnley	157				
Exner	22				
House	191				
MacEwen	221				
Mackie	191				
St Clair Thompson	191				
Sharman	75				
Sims	75				
Stanley Boyd	157				
Volkman	157				
<b>Currie</b>					
Uterine Scissors	81				
<b>Cusco</b>					
Vaginal Specula	84				
<b>Cushing</b>					
Artery Forceps	140				
Retractors	147				
Rongeurs	150				
<b>Cut-Out Adaptor</b>	211				
<b>Czerny</b>					
Retractors	33				
<b>D</b>					
<b>Dandy</b>					
Retractors	147				
<b>Davis-Boyle</b>					
Mouth Gags	198				
<b>Deaver</b>					
Retractors	33				
<b>DeBakey</b>					
Clamps, Atraumatic	64,65				
Needleholders, TC	26				
Tissue Forceps	69				
<b>De Martel Gigli Guide</b>	154				
<b>Denis Browne</b>					
Collar Crushing Forceps	220				
Intestinal Forceps	21				
Tonsil Holding Forceps	214				
<b>Dental Files</b>					
Miller	128				
<b>Derf</b>					
Needleholders	23				
Needleholders, TC	26				
<b>Deschamps</b>					
Needles	29				
<b>Desjardins</b>					
Gallstone Forceps	21				
<b>Desmarres</b>					
Retractors	230				
<b>Diathermy</b>					
Cable	11				
Carriers	12				
Electrode	12				
Electrode, Knife	12				
Handles	12				
Loops	12				
Needles	12				
Quiver	12				
<b>Diathermy Forceps</b>					
Adson	13				
Dissecting	13				
Gillies	13				
McIndoe	13				
Remington-Hobbs	192				
Riches	14				
Waugh	14				
Wilson Hey	14				
<b>Diathermy Scissors</b>					
Turner-Warwick	15				
<b>Dilators</b>					
Hegar, Cervix	76				
St Mark's	92				





Files (cont)					
Bone Rasp/File	164				
Tubby	164				
Finch					
Clamps	91				
Finochietto					
Needleholders, TC	27				
Rib Spreaders	68				
Flat Nose Pliers	130				
Foerster					
Sponge Holding Forceps	56				
Foley Balloon					
Catheter Introducers	87				
Forceps Jar	61				
Formby					
Cerumen Hooks	190				
Suction Tubes	210				
Foster Gillies					
Needleholders	226				
Needleholders, TC	227				
Foster Miniature					
Needleholders	226				
Fraser Kelly					
Artery Forceps	2				
Freer					
Elevators	193				
Nasal Instruments	200				
French Bow					
Dressing Forceps	20				
Frenchay					
Towel Clips	59				
Fuller					
Aural Forceps	180				
Furnace Tweezers	132				
<b>G</b>					
Gabriel					
Rectal Specula	94				
Galabin					
Sounds	83				
Gallipots Gallstone Forceps	61				
Desjardins	21				
Gardiner Brown					
Tuning Forks	216				
Geary Grant					
Cholecystectomy Forceps	7				
Gelpi Vulva					
Retractors, Self-Retaining	79				
Giertz					
Rib Shears	67				
Gigli					
Saws	154				
Gillies					
Diathermy Forceps	13				
Gillies					
Dissecting Forceps	17				
Needleholders	226				
Needleholders, TC	227				
Osteotomes	228				
Skin Hooks Suction Tubes	235				
Tubes	83				
Glasgow					
Iris Scissors	44				
Rongeurs	153				
Glegg					
Aural Snare	187				
Nasal Snare	201				
Goligher					
Retractors, Self-Retaining	36				
Scissors	96				
Goodwin					
Peritoneum Forceps	78				
Gosset					
Retractors, Self-Retaining	36				
Gouges					
Capener	145				
Guy's	194				
Jenkins	194				
Killian	194				
Read	223				
Smith-Petersen	165				
Swedish	165				
Tilley	194				
Tufnol Handle	165				
Graves					
Vaginal Specula	84				
Green Armytage					
Peritoneum Forceps	78				
Grey Turner					
Artery Forceps	2				
Grunwald					
Turbinate Forceps	216				
Guides					
Pudendal Nerve Block	76				
Gum Scissors	131				
Guyon					
Catheter Introducers	87				
Guy's					
Gouges	194				
Shears	30				
Suture Forceps	57				
Tenotomy Knives	167				
Tongue Forceps	59				
Gwilliam					
Clamps	73				
Gwynne Evans					
Dissectors	192				
<b>H</b>					
Haemorrhoid Forceps					
St George's	94				
Haemorrhoid Ligator Set					
Barron	93				
McGivney	39				
Hajek					
Mallets Punch	168				
Forceps	206				
Retractors	230				
Halsey					
Needleholders	24				
Needleholders, TC	27				
Hammer					
Post Mortem	31				
Hand Drills					
Pistol Grip	165				
Ralk	166				
Hand Instruments, Dental					
Amalgam	115				
Amalgam Carrier	115				
Blacks	117,118				
Burnishers	115				
Carvers	116,117				
Condensers	115				
Excavators	118,119				
Plastics	119-121				
Pluggers	115				
Probes	122-124				
Scalers	125-127				
Spatulas	127				
Hand Splint, Lead Handle	166				
Diathermy Wire Instruments	12				
Instruments	177				
Harrison					
Oral Forceps	227				
Harrison Cripps					
Artery Forceps	2				
Hartmann					
Aural Dressing Forceps	183				
Aural Forceps	180				
Conchotomes	190				
Nasal Forceps Tuning Forks	199				
Forks	216				
Harvey-Jackson					
Retractors, Self-Retaining	148				
Hayes					
Clamps, Atraumatic	92				
Hayton Williams					
Wire Forceps	236				
Heaney					
Clamps	74				
Heaths					
Mallets	168				
Heaths (cont)					
Scissors	44				
Wool Carriers	217				
Hegar					
Dilators, Cervix	76				
Needleholders	24				
Heiss					
Artery Forceps	2				



<b>Henckel</b>	
Aural Forceps	181
Punch Forceps	206
<b>Henderson</b>	
Retractors, Self-Retaining	149
<b>Hennig</b>	
Spreader	30
<b>Hernia Forceps</b>	
Collingwood Stewart	11
<b>Herrick</b>	
Clamps, Atraumatic	88
<b>Hey Groves</b>	
Bone Holding Forceps	160
<b>Hibbs</b>	
Retractors	147
<b>Hill</b>	
Elevators	193
<b>Hohmann-Muller Spike</b>	
Retractors	172
<b>Holloware</b>	
Forceps Jar	61
Gallipot	61
Instrument Lid	61
Instrument Tray	61
Jug, Graduated	61
Kidney Dish	61
Lotion Bowl	61
<b>Horrocks</b>	
Sounds	83
<b>Horsley</b>	
Bone Cutting Forceps	158
<b>Hospital</b>	
Elevators	100
<b>Hough</b>	
Aural Forceps	181
<b>House</b>	
Curettes	191
Nasal Instruments	200
Suction Tubes	210
<b>House-Dieter</b>	
Aural Forceps	181
<b>Howarth</b>	
Elevators	222
<b>Howe</b>	
Pliers	130
<b>Hudson</b>	
Brace	140
Burs	141
<b>Hughes Stapes</b>	
Nasal Instruments	200
<b>Hunter</b>	
Splinter Forceps	55
<b>Hunter Tod</b>	
Aural Dressing Forceps	183
<b>Hurd</b>	
Dissectors	192

<b>Hysterectomy, Clamps</b>	
Atraumatic	74

## I

<b>Inflation Bellows</b>	97
<b>Instrument Pins</b>	
Mayo	21
<b>Instrument Trays</b>	61
<b>Intestinal Forceps</b>	
Denis Browne	21
<b>Introducing Forceps</b>	
Magill	22
<b>Iris</b>	
Dissecting Forceps	18
Scissors	45
Scissors, Hard Edge	51
scissors, Ultra-Cutting	53
<b>Irwin Moore</b>	
Laryngeal Forceps	195
Turbinate Forceps	217

## J

<b>Jackson Burrows</b>	
Dissecting Forceps	164
Retractors	173
Retractors, Self-Retaining	174
<b>Jansen</b>	
Retractors, Self-Retaining	149
Rongeurs	153, 174
<b>Jansen-Middleton</b>	
Septum Forceps	233
<b>Jears</b>	
Dissecting Forceps	18
<b>Jefferson</b>	
Cannula Dissecting	141
Forceps Dressing	143
Forceps	144
Retractors, Self-Retaining	149
<b>Jenkins</b>	
Chisels	219
Gouges	194
<b>Jobson Horne Probes</b>	205
<b>Johnson</b>	
Pliers	130
<b>Jolls</b>	
Artery Forceps	2
Needles	29
Retractors, Self-Retaining	37
<b>Jones</b>	
Rugines Tenotomy	175
Knives	167
<b>Joseph</b>	
Nasal Rasps	229
Nasal Saws	226

<b>Judd-Allis</b>	
Tissue Forceps	58
<b>Jug, Graduated</b>	61

## K

<b>Kay Austin</b>	
Retractors	230
<b>Kelly</b>	
Proctoscopes	94
Rectal Specula	94
Retractors	33
<b>Kelly-Crile</b>	
Artery Forceps	3
<b>Kelsey Fry</b>	
Bone Awls	219
<b>Kerrison</b>	
Rongeurs	151
<b>Kidney Dish</b>	61
<b>Kielland</b>	
Obstetric Forceps	77
<b>Killian</b>	
Gouges	194
Nasal Specula	202
<b>Kilner</b>	
Artery Forceps	3
Elevators	222
Needleholders	24
Needleholders, TC	27
Retractors	230, 231
Scissors	233
Scissors, Ultra-Cutting	53
Skin Hooks	235
<b>Knight (Heymann)</b>	
Scissors	209
<b>Knives</b>	
Adams Tenotomy	166, 167
Blake	128
Brain	22
Cartilage	22
Catlin	22
Guy's Tenotomy	167
<b>Knives (cont)</b>	
Jones Tenotomy	167
Liston	22
Monro Menisectomy	167
Paget	22
Parker Tenotomy	167
Plaster	128
Post Mortem	32
Smillie Menisectomy	167
Tenotomy	168
Tubby Tenotomy	168
Wax	128
<b>Knot Tier and Pusher</b>	
Negus	195
<b>Kocher</b>	
Artery Forceps Bone	3
Hook Clamps,	161
Intestinal Dissector,	8
Thyroid	20





## L

<b>Lack</b>	
Tongue Depressors	213
<b>Lagrange</b>	
Scissors	44
<b>Lahey</b>	
Cholecystectomy Forceps	7
<b>Landon</b>	
Retractors	79
<b>Lane</b>	
Bone Holding Forceps	160
Bone Lvers	162
Clamps, Intestinal	8
Clamps, Twin	9
Dissecting Forceps	18, 221
Plate Blender	171
Tissue	58
<b>Lang Stevenson</b>	
Clamps	9
<b>Langenbeck</b>	
Bone Hooks	161
Retractors	34
<b>Laryngeal Forceps</b>	
Chevalier Jackson	195
Irwin Moore	195
Micro	196
<b>Laryngeal Mirrors</b>	197
<b>Laster Cheek</b>	
Retractors	231
<b>Lawrance</b>	
Needleholders	24
Needleholders, TC	27
<b>Lawson Tait</b>	
Wire Forceps	236
<b>Lead Hand Splint</b>	166
<b>Leech Wilkinson</b>	
Biopsy Punch	71
Cannula	72
<b>Leedham Green</b>	
Dissecting Forceps	18
<b>Leksell</b>	
Rongeurs	174
<b>Lempert</b>	
Nibbling Forceps	203
Rongeurs	174
Rugines	208
Scoops Suction	210
Tubes	211
<b>Lewer</b>	
Vulsellum Forceps	85
<b>Ligature Cutters</b>	130
<b>Lindo Levien</b>	
Elevators	101
<b>Lister</b>	
Scissors	45
Sinus Forceps	55

<b>Liston</b>	
Bone Cutting Forceps	158
Knives	22
<b>Liston-Key</b>	
Bone Cutting Forceps	159
<b>Littauer</b>	
Scissors	46
<b>Littlewood</b>	
Tissue Forceps	58
<b>Lloyd-Davies</b>	
Clamps	91
Retractors	95
Scissors	96
Sigmoidoscopes	97
<b>Lockhart Mummery Fistula</b>	
Directors	92
<b>Loops</b>	
Diathermy	12
<b>Lotion Bowl Loute</b>	61
<b>Tightener Love</b>	177
Retractors	147
<b>Love-Grunwald</b>	
Rongeurs	152
<b>Lowman</b>	
Bone Holding Clamps	159
<b>Luc</b>	
Turbinate Forceps	217
<b>Lucae</b>	
Aural Dressing Forceps	183
Cerumen Hooks Nasal	190
Forceps	199
<b>Luer</b>	
Rongeurs Vulsellum	174
Forceps	85
<b>Lung Forceps</b>	
Duval	66
Mayo	66

## M

<b>McClintock</b>	
Ovum Forceps	78
<b>McGee</b>	
Aural Forceps	182
<b>McGivney</b>	
Haemorrhoid Ligator Set	93
<b>McGoey</b>	
Punches	171
<b>McIndoe</b>	
Bone Cutting Forceps	159
Chisels	219
Diathermy Forceps	13
Dissecting Forceps	18
Raspatories	228
Skin Hooks	235

<b>McKenzie</b>	
Clip Forceps	142
<b>McKissock</b>	
Scissors	155
<b>MacDonald</b>	
Dissectors	20
<b>MacEwen</b>	
Curettes	221
<b>MacPhail</b>	
Needleholders	24
<b>Mackie</b>	
Curettes	191
<b>Magauran Plate</b>	189
<b>Magill</b>	
Introducing Forceps	22
Suction Tubes	211
<b>Maingot</b>	
Clamps Dissecting	74
Forceps	19
<b>Mallets</b>	
Fickling	223
Hajek	168
Heath	168
Mead Stainless	169
Steel Toffee	169
Hammer	223
<b>Maltz</b>	
Rasps	229
<b>Mapping Pens</b>	
Eckhoff	223
Sommerlad	223
<b>Marthew</b>	
Pliers	129
<b>Martin</b>	
Splinter Forceps	55
<b>Mathieu</b>	
Needleholders	24
<b>Matrix Clamp</b>	
Sigveland	133
<b>Maxilla Instruments</b>	
Awls	224
Chisel	224
Osteotome	224
Raspatory	224,225
Retractor	225
<b>Mayo</b>	
Artery Forceps	3
Instrument Pins	21
Lung Forceps	66
Needleholders	25
Needleholders, TC	27
Scissors	46
Scissors, Hard Edge	51
Scissors, Ultra-Cutting	53
Tongue Forceps	59
<b>Mayo Adson</b>	
Retractors, Self-Retaining	149





<b>Nelson</b>	
Dissecting Forceps	66
Scissors	48
Scissors, Hard Edge	52
<b>Nibbling Forceps</b>	
Lempert	203
<b>Nickel Silver Probes</b>	32
<b>Nippers</b>	
Chiropody	136, 137
<b>Nodule Forceps</b>	
Chevalier Jackson	203
<b>Noise Apparatus</b>	
Barany	204
<b>Norfolk and Norwich</b>	
Retractors, Self-Retaining	37
<b>Northfield</b>	
Rongeurs	152, 153

## O

<b>Obstetric Forceps</b>	
Barnes	77
Kielland	77
Simpson	77
Wrigley	77
<b>O'Connell</b>	
Retractors	147
<b>Officer</b>	
Dissecting Forceps	93
<b>Olsen Hegar</b>	
Needleholders	25
Needleholders, TC	28
<b>Oral Forceps</b>	
Fickling	227
Harrison	227
Rowe Disimpaction	227
<b>Ormerod</b>	
Aural Forceps	182
Scissors	209
<b>Oschner</b>	
Artery Forceps	5
<b>O'Shaughnessy</b>	
Artery Forceps	5
<b>Osteotomes</b>	
Albee	169
Capener	169, 170
Gillies	228
Maxilla	224
Read	228
Smith-Petersen	170
Swedish	170
Ward	228
<b>Ostrom</b>	
Punch Forceps	206
<b>Ovum Forceps</b>	
McClintock	78

## P

<b>Paget</b>	
Knives	22
<b>Palate Lever</b>	
Angell James	204
<b>Park</b>	
Retractors, Self-Retaining	95
Scissors, Lower Colonic	96
<b>Parker</b>	
Tenotomy Knives	167
<b>Parker Kerr</b>	
Clamps	9
<b>Parker-Langenbeck (US Army)</b>	
Retractors	34
<b>Paterson</b>	
Biopsy Forceps	188
<b>Paton</b>	
Bone Cutting Forceps	159
Burs	163
<b>Paynes Suture</b>	
Scissors	48
<b>Payr</b>	
Clamps	10
<b>Pennybacker</b>	
Dissecting Forceps	143
Dissectors	143
Elevator	145
Rongeurs	152, 153
<b>Perforators</b>	
Myles	204
<b>Periosteal Elevators</b>	99
<b>Peritoneum Forceps</b>	
Goodwin Green	78
Armytage	78
<b>Perry</b>	
Dental Tweezers	132
<b>Pin Introducer</b>	
Steinmann	171
<b>Pinard</b>	
Stethoscopes, Foetal	83
<b>Pistol Grip Hand Drill</b>	165
<b>Pituitary Forceps</b>	
Bateman	205
Wilson	205
<b>Plaster Instruments</b>	
Bohler Bender	30
Bruns/Bohler Shears	30
Guy's Shears	30
Hennig Spreader	30
Stille-Lorenz Shears	30
<b>Plaster Knives</b>	128
<b>Plastic Instruments, Dental</b> 119-121 Plate Bender	
Lane	171

<b>Pliers, Dental</b>	
Adams	130
Band Removing	130
Flat Nose	130
Howe	130
Johnson	130
Ligature Cutters	130
Marthew	129
Pullan	129
Schroeder	129
Universal	129
<b>Pliers, Wire</b>	177
<b>Pluggers, Dental</b>	115
<b>Poirier</b>	
Tissue Forceps	58
<b>Politzer</b>	
Myringotomes	199
<b>Pollocks</b>	
Rib Shears	31
<b>Poole</b>	
Suction Tubes	57
<b>Portmann</b>	
Scissors	209
<b>Post Mortem Instruments</b>	
Chisel	31
Hammer	31
Knife	32
Shears, Infant Skull	31
Shears, Eslander	31
Spine Wrench	32
<b>Post Mortem Scissors</b>	48
<b>Potts Smith</b>	
Scissors	68
Scissors, Hard Edge	69
<b>Probes</b>	
Brodie	32
Chiropody	135
Dental	122-124
Jobson Horne	205
Nickel Silver	32
Sinus	32
<b>Proctoscopes</b>	
Kelly	94
<b>Pudendal Nerve Block Guide</b> 76	
<b>Pullen</b>	
Pliers	129
<b>Punches</b>	
McGoey	171
<b>Punch Forceps</b>	
Angell James	205
Citelli	206
Hajek	206
Henckel	206
Ostrom	206
St Bartholomew's	207
Seymour Jones	207
Tilley Henckel	207
<b>Putti</b>	
Rasps	172



## Q

Quiver Diathermy 12

## R

Ralk Hand Drill 166

Rampley  
Sponge Holding Forceps 56

Ramsey  
Dissecting Forceps 19

Randall Renal Calculus  
Stone Forceps 89

Raney  
Clip Forceps 142

Raspatories  
Barsky 228  
Cleft Palate 228  
Maxilla 224,225  
McIndoe 228  
St Thomas 171

Rasps  
Joseph 229  
Maltz 229  
Putti 172

Read  
Chisels 220  
Elevators 101  
Gouges 223  
Osteotomes 228

Rectal Specula  
Gabriel 94  
Kelly 94  
Naunton Morgan 95

Remington-Hobbs  
Diathermy Forceps 192

Retractors  
Allison Lung 67  
Aufrecht 207  
Bowdler-Henry 230  
Cairns 146  
Canny Ryall 33  
Charnley 172  
Charnley Initial Incision 172  
Charnley Laminectomy 146  
Cushing 147  
Czerny 33  
Dandy 147  
Deaver 33  
Desmarres 230  
Doyen 33  
Doyen (Pozzi) 79  
Durham 33  
Hajek 230  
Hibbs 147

Hohmann-Muller Spike 172  
Jackson Burrows Kay 173  
Austin 230  
Kelly 33  
Kilner 230, 231  
Landon 79  
Langenbeck 34  
Laster Cheek 231  
Lloyd-Davies 95  
Love 147  
Maxilla 225  
Millin Bladder 89  
Morris 34  
Moynihan 34  
O'Connell 147  
Parker-Langenbeck 34  
Rowe Buccal 231  
Rowe Lingual 231  
St Marks Hospital 34  
Smillie Hook Tracheal 173  
Hook 35  
Tudor Edwards 67  
Volkmann 35  
Ward 232  
Walton 35  
Wertheim 79

### Retractors, Amputation

Blake Flap 36

### Retractors, Self-Retaining

Adson 36  
Alms 232  
Balfour 36  
Cone 148  
Gelpi Vulva 79  
Goligher 36  
Gosset 36  
Harvey-Jackson 148  
Henderson 149  
Jackson Burrows 174  
Jansen 149  
Jefferson 149  
Jolls 37  
Mayo Adson 149  
Mollison 208  
Norfolk and Norwich 37  
Park 95  
Park Anal 95  
Travers 37  
Weislander 37  
Weitlander 37  
West 37

### Rib Shears

Giertz 67  
Spring 67  
Tudor Edwards 67

### Rib Spreaders

Bailey 68  
Finochietto 68  
Sellors 68  
Tuffier 68

### Riches

Diathermy Forceps 14

Ring Cutter 38

Roberts  
Artery Forceps 63

Robin  
Anchoring Forceps 1

Rochester-Pean  
Artery Forceps 6

Ronald Edwards  
Artery Forceps 6

Rongeurs  
Beck 150  
Cushing 150  
Dental 114  
Ferris-Smith-Kerrison 151  
Glasgow 153  
Jansen 153, 174  
Kerrison 151  
Leksell 174  
Lempert 174  
Love-Grunwald 152

### Rongeurs (cont)

Luer 174  
Northfield 152,153  
Pennybacker 152, 153  
Ruskin 154  
Trotter 154  
Van Havre (Sargent) 154

### Rosen

Aural Instruments 185  
Aural Specula 187

### Rotunda

Catheters 72

### Rowe

Elevators, zygomatic 222  
Oral Forceps 227  
Retractors, Buccal 231  
Retractors, Lingual 231

### Rugines

Farabeuf 175  
Jones 175  
Lempert 208

### Ruskin

Rongeurs 154

### Rutherford Morison

Tissue Forceps 59

### Ryder

Needleholders, TC 28

## S

### St Bartholomew's

Cerumen Hooks 190  
Punch Forceps 207

### St George's

Haemorrhoid Forceps 94



<b>St Clair Thompson</b>		Elliot Iris	43	<b>Sellors</b>	
Curettes	191	Enucleation	44	Rib Spreaders	68
Dissectors	193	Fergusson	44	<b>Semb</b>	
Mirrors, Rhinoscope	197	Glasgow Iris	44	Clamps	63
Nasal Specula	202	Goligher	96	<b>Septum Forceps</b>	
<b>St Marks Hospital</b>		Heaths	44	Asch	233
Dilators	92	Iris	45	Jansen-Middleton	233
Dissecting Forceps	19	Kilner	233	Walsham	234
Retractors	34	Knight (Heymann)	209	<b>Seymour Jones</b>	
<b>St Thomas</b>		Lagrange	45	Punch Forceps	207
Bone Holding Forceps	161	Lister	46	<b>Shardle</b>	
Raspatories	171	Littauer	96	Towel Clips	59
<b>Satinsky</b>		Lloyd-Davies	155	<b>Sharman</b>	
Clamps, Atraumatic	65,66	McKissock	46	Curettes	75
<b>Saws</b>		Mayo	47	<b>Shea</b>	
Amputation	38	Metzenbaum	46	Aural Forceps	182
De Martel Gigli Guide	154	Monaghan	47	<b>Shears</b>	
Engels	38	Nelson Lobectomy	81	Pollocks	31
Gigli	154		48	Rib	31
<b>Sawtell</b>		<b>Scissors (Cont)</b>		Skull	31
Artery Forceps	179	Ormerod	209	Swedish Laminectomy	155
<b>Scalers, dental</b>	125-127	Parks	96	<b>Siegle (Peters)</b>	
<b>Scalpels</b>		Paynes Suture	48	Aural Specula	187
Barron	232	Portmann	209	<b>Sigmoidoscopes</b>	
Chiropody	136	Post Mortem	48	Inflation Bellows	97
Swann Morton	39,40	Potts Smith	68	Lloyd-Davies	97
<b>Schnidt</b>		Scott Stevenson	209	<b>Silver</b>	
Artery Forceps	179	Spencer	49	Chisels	220
<b>Schoemaker-Ogilvie</b>		Stevens	48, 49	Skin Graft Knives	235
Clamps	10	Strabismus	49	<b>Simpson</b>	
<b>Schroeder</b>		Umbilical	81	Obstetric Forceps	77
Dental Pliers	129	Universal Bandage	49	<b>Sims</b>	
Vulsellum Forceps	85	Universal Wire Cutting	49	Curettes	75
<b>Schubert</b>		Uterine	82	Sounds V	83
Biopsy Punch	71	Vant	82	aginal Specula	84
<b>Schuknecht</b>		Wilson	209	<b>Sinus Forceps</b>	
Aural Instruments	186	Woods	209	Lister	55
<b>Scissors</b>		<b>Scissors, Hard Edge</b>		<b>Sinus Probes</b>	32
Abel	96	Dressing	50	<b>Skin Graft Boards</b>	234
Alar	232	Iris	51	<b>Skin Graft Knives</b>	
Aufricht	41	Mayo	51	Braithwaite	235
Barnes	80	Mayo-Stille	51	Cobbett	235
Bowel	41	Metzenbaum	51, 52	Silver	235
Braun-Stadler	80	Nelson Lobectomy	52	Watson	235
Cairns	155	Potts Smith	69	<b>Skin Hooks</b>	
Campbell	232	Strabismus	52	Gillies	235
Capsulotomy	175	Universal Wire Cutting	52	Kilner	235
Carless	42	<b>Scissors, Ultra-Cutting</b>		McIndoe	235
Cartilage	41	Dressing	53	<b>Smillie</b>	
Cawthorne	208	Iris	53	Hook Retractors	173
Chassar Moir	80	Kilner	53	Menisectomy Knives	167
Chiropody	137	Mayo	53	<b>Smith Petersen</b>	
Currie Uterine	81	Mayo Stille	54	Chisels	163
Dental	131	Metzenbaum	54	Gouges	165
Dissecting	42	Stevens	54	Osteotomes	170
Doyen	42	Strabismus	54		
Dressing	42, 43	<b>Scoops</b>			
		Lempert	210		
		<b>Scott Stevenson</b>			
		Scissors	209		



Sommerlad					
Mapping Pens	223				
Sounds					
Galabin	83				
Horrocks	83				
Sims	83				
Spackman					
Cannula, Intra Uterine	72				
Spatulas Dental	127				
Spencer					
Scissors	49				
Spencer-Wells					
Artery Forceps	6				
Sphygmomanometers					
Aneriod	55				
Spinal Elevators	164				
Spine Wrench					
Post Mortem	32				
Splinter Forceps					
Arthur	55				
Hunter	55				
Martin	55				
Sponge Holding Forceps					
Foerster	56				
Rampley	56				
Spring Clip	176				
Stamm					
Bone Cutting Forceps	159				
Stanley Boyd					
Bone Curettes	157				
Staple Instruments					
Blount	176				
Steinmann					
Pin Introducer	171				
Steriliser Forceps					
Cheatles	56				
Stethoscopes					
Binaural	56				
Nurse	56				
Pinard Foetal	83				
Stevens					
Scissors	48,49				
Scissors, Ultracutting	54				
Stiles					
Tissue Forceps	59				
Stille-Lorenz					
Shears	30				
Stirrups					
Bohler	176				
Stone Forceps					
Randall Renal Calculus	89				
Strabismus					
Scissors	49				
Scissors, Hard Edge	52				
Scissors, Ultra-Cutting	54				
Suction Tubes					
Adson Frazier	155				
American	57				
Barron	210				
Bellucci	210				
Cut-Out Adaptor	211				
Falconer	155				
Formby	210				
Gillies	83				
House	210				
Lempert	211				
Magill	211				
Poole	57				
Self-Clearing	211				
Tinckler (Simpson Smith)	57				
Verhoeven	211				
Yankauer	57				
Zoellner	212				
Sulleys					
Tubing Clamps	60				
Suture Forceps					
Charnley	177				
Guy's	57				
Mustarde	236				
Swann Morton					
Scalpels	39,40				
Swedish					
Chisels	163				
Dissectors	143				
Gouges	165				
Osteotomes	170				
Shears, Laminectomy	155				
Syme					
Dissectors	193				
Needles	29				
Syringe					
Aspirating	133				
Aural	212				
Bacon	212				
Cartridge	133				
<b>T</b>					
Tabb Crura					
Aural Forceps	183				
Teales					
Vulsellum Forceps	85				
Tenotomy Knives	167,168				
Thompson-Walker					
Needleholders	25				
Needleholders, TC	28				
Pedicle Clamps	88				
Penile Clamps	88				
Thudichum					
Nasal Specula	203				
Thwaites					
Nippers	137				
Tilley					
Aural Dressing Forceps	183				
Burs	189				
Gouges	194				
Nasal Forceps	199				
Tilley Harpoon					
Trocars	215				
Tilley Henckel					
Punch Forceps	207				
Tilley Lichtwitz					
Trocars	215				
Tinckler (Simpson Smith)					
Suction Tubes	57				
Tissue Forceps					
Allis	58				
Babcock	58				
DeBakey	69				
Tissue Forceps (cont)					
Duval	58				
Judd-Allis	58				
Lanes	58				
Littlewood	58				
Poirier	58				
Rutherford Morison	59				
Stiles	59				
Toffee Hammer	223				
Tongue Depressors					
Flat	213				
Lack	213				
Tongue Forceps					
Collin	213				
Guy's	59				
Mayo	59				
Young	213				
Tongue Plates					
Mouth Gags	198				
Tonsil Holding Forceps					
Denis Browne	214				
Tonsil Snare					
Eve	214				
Towel Clips					
Backhaus	59				
Frenchay	59				
Shardle	59				
Tracheal Dilators					
Trousseau	214				
Tracheal Hook					
Retractors	35				
Tracheostomy Tubes					
Chevalier Jackson	215				
Negus	215				
Trautmann					
Myringotomes	199				
Travers					
Retractors, Self Retaining	37				
Trethowan					
Bone Levers	162				



<b>Treves</b>	
Dissecting Forceps	19
<b>Trocars</b>	
Tilley Harpoon	215
Tilley Lichtwitz	215
<b>Trotter</b>	
Rongeurs	154
<b>Trousseau</b>	
Tracheal Dilators	214
<b>Tubby</b>	
File	164
Tenotomy Knives	168
<b>Tubing Clamps</b>	
Sulleys	60
Wedge Jaw	60
<b>Tudor Edwards</b>	
Elevators, Periosteal	66
Lung Retractors Rib Shears	67
<b>Tuffier</b>	
Rib Spreaders	68
<b>Tumarkin</b>	
Aural Specula	187
<b>Tuning Forks</b>	
Alloy	216
Gardiner Brown	216
Hartmann	216
<b>Turbinate Forceps</b>	
Grunwald	216
Irwin Moore	217
Luc	217
<b>Turner-Warwick</b>	
Diathermy Scissors	15
<b>Turn-Over-End</b>	
Dissecting Forceps	19
<b>Tweezers, Dental</b>	
College	132
Dressing	132
Furnace	132
Guttman	132
Perry	132
Plugging	132
Self-Locking	132
<b>U</b>	
<b>Umbilical</b>	
Scissors	81
<b>Universal Bandage Scissors</b>	49
<b>Universal Pliers</b>	129
<b>Universal Wire Cutting</b>	
Scissors	49
Scissors, Hard Edge	52
<b>Uterine</b>	
Scissors	82
<b>Uterine Forceps</b>	
Bonney	83

<b>V</b>	
<b>Vaginal Specula</b>	
Auvard	84
Cusco	84
Graves	84
Sims	84
<b>Van Doren</b>	
Biopsy Punch	71
<b>Van Havre (Sargent)</b>	
Rongeurs	154
<b>Vant</b>	
Scissors	82
<b>Vasectomy</b>	
Clamps	60
Forceps	60
<b>Verbrugge</b>	
Bone Holding Forceps	161
<b>Verhoeven</b>	
Suction Tubes	211
<b>Volkman</b>	
Bone Curettes	157
Retractors	35
<b>Vulsellum Forceps</b>	
Lewer	85
Luer	85
Schroeder Uterine Teales	85

<b>W</b>	
<b>Walsham</b>	
Septum Forceps	234
<b>Walton</b>	
Retractors	35
<b>Ward</b>	
Bone Cutting Forceps	219
Chisels	220
Elevators	222
Needleholders	25
Osteotomes	228
Retractors	232
<b>Warwick James</b>	
Elevators	101
<b>Watson</b>	
Skin Graft Knives	235
<b>Watson Cheyne</b>	
Dissectors	20
<b>Watson-Williams</b>	
Nasal Rasp	201
<b>Waugh</b>	
Diathermy Forceps	14
Dissecting Forceps	20
<b>Wax Knives</b>	128
<b>Webster</b>	
Needleholder, TC	28

<b>Weislander</b>	
Retractors, Self-Retaining	37
<b>Weitlaner</b>	
Retractors, Self-Retaining	37
<b>Welster</b>	
Needleholders	28
<b>Wertheim</b>	
Retractors	79
<b>West</b>	
Retractors, Self-Retaining	37
<b>Wilde</b>	
Aural Dressing Forceps	184
<b>Wilson</b>	
Artery Forceps	179
Pituitary Forceps	205
Scissors	209
<b>Wilson Hey</b>	
Diathermy Forceps	14
<b>Winters</b>	
Root Elevators	102
<b>Wire Cutters</b>	236
<b>Wire Forceps</b>	
Hayton Williams	236
Lawson Tait	236
<b>Wire Instruments</b>	
Handle	177
Loute	177
Pliers	177

<b>Wittner</b>	
Biopsy Punch	71
<b>Woakes</b>	
Eustachian Catheters	189
<b>Woods</b>	
Scissors	209
<b>Wool Carriers</b>	
Heath	217
Musgrove	217
<b>Wrigley</b>	
Obstetric Forceps	77

<b>Y</b>	
<b>Yankauer</b>	
Suction Tubes	57
<b>Yeomans</b>	
Biopsy Forceps	91
<b>Young</b>	
Tongue Forceps	213

<b>Z</b>	
<b>Zoellner</b>	
Suction Tubes	212

## SYCHEM SURGICAL

**Combining over 100 years of experience in the sterilisation industry with over 75 years of manufacturing surgical instruments, Sychem Surgical has positioned itself as leading specialists in the medical, healthcare, and laboratory sectors.**

In 2023, Sychem Surgical acquired the surgical division of S Murray Ltd, a well established surgical instrument manufacturer based in Sheffield, UK.

S Murray have been manufacturing from their facility since 1946 and bring a wealth of experience and knowledge to our ever-growing team.

We work with a number of partners and distributors across the world to enhance and bring to market our extensive product portfolio, whilst continuously expanding our reach. We are always open to new opportunities within the surgical sector and welcome routes into new markets and countries.